



POLY

**LANEMA**

TECHNICAL CATALOGUE 2019

**ENGINEERING PLASTICS**

and TECHNICAL ALUMINIUM



## THE PURPOSE OF LANEMA



LANEMA's mission is to create long-term economic and social value by transmitting the benefits of progress and innovation to an increasing number of people.

The company promotes a Quality of excellence policy, counting on a specialized and ambitious multidisciplinary team that continuously has access to the most advanced technological means.

The bet on innovation, quality and rigor are the basis of our leadership and positioning strategy, promoting distinction and unique prestige in the market.

## THE PRINCIPLES AND OBJECTIVES OF QUALITY



- To promote the continuous improvement of internal processes;
- To raise and exceed the level of satisfaction of the most demanding customers;
- Commitment to meet applicable requirements:
- To continuously train HR in order to develop individual skills and value teamwork;
- To use the Q.M.S. as an important means of assisting the organization's mission;
- The correct functioning of the Q.M.S. based on standard NP EN ISO 9001.

**Poly Lanema, Lda.**  
Zona Industrial de Ovar  
Rua do Brasil, N.º 143  
3880-108 Ovar - Portugal

T: +351 256 581 400  
F: +351 256 581 419

GPS: 40° 52' 55.164" -8° 37' 30.8742"  
polylanema@lanema.pt

www.polylanema.pt



**SHAPING  
YOUR PROJECTS**





## OUR VALUES



### CONTINUOUS IMPROVEMENT. EXCELLENCE. INNOVATION.

We live with the existence of daily challenges! We believe that identification and standardization of processes are the key to our differentiation. By reinventing processes and identifying opportunities, innovation for LANEMA will always be the result of curiosity combined with dedication and creativity. We want to be different and that involves improvement in everything we do! Excellence will always be our motivation!

### COMMITMENT.

It is the promise of daily dedication! It is a bond and an individual commitment. "To be company people" is what makes us ready for any challenge. Consistency and our professional integrity are the air we breathe!

### PEOPLE. TEAM. KNOWLEDGE.

We believe that people and their motivation are the lever for success. Teams are the mirror of responsibility and excellence that ensure that every day we can grow and achieve goals.

### FOCUS ON THE CUSTOMER.

The Customer is the reason why we exist. Our focus is the anticipation of their expectations and learning about them. Getting their trust and loyalty is the basis of our sustainability.





## **BENEFIT YOUR PROJECT WITH OUR KNOWLEDGE**

A specialized team prepared to suggest the best solution.



## **WE HAVE THE MOST INDICATED MATERIAL FOR YOUR APPLICATIONS**

In order not to delay your projects, we provide more than 3,000 tons in stock of engineering plastics and technical aluminium distributed over an area of approximately 13,000 sqm.

# **THE ADVANTAGES YOU CAN GET FROM OUR PROCESS**





## PRECISION AND OPTIMIZATION AT YOUR DISPOSAL

We cut your materials without changing their technical and mechanical characteristics. In order to do so, we provide modern and precise cutting tools.



## CNC MACHINING

Versatility and manufacturing availability of parts of great complexity and dimension, reducing the delivery time and ensuring the success of your projects.



## REDUCE YOUR COSTS WITH OUR WATERJET CUTTING SERVICE

Through specific dimensional use software programs, we obtain optimized nesting, thus reducing waste.





DON'T DELAY  
YOUR PROJECTS.  
**WE HAVE  
THE MATERIAL!**













POLY  
**LANEMA**®  
 AERONAUTICS

The aeronautics industry is known for its high complexity and quality control.

The sector, in great expansion, increasingly requires the mastery of all the parameters that assure quality. All processes, whether operational or productive, must be robust.

Polylanema Aeronautics® is created, representing the portfolio of Aluminium and Engineering Plastics available for the Aeronautics, Aerospace and Defence Industries.

This evolution has been sustainable, representing the Group's reputation throughout more than 25 years, during which we have had the opportunity to supply materials and components to the most complex and rigorous industries, including Aeronautics.



### CERTIFIED PLASTICS

- DURATRON® PBI
- DURATRON® PI
- DURATRON® PAI
- DURATRON® PEI
- KETRON® PEEK
- QUADRANT® PPSU
- FLUOROSINT®
- TECHTRON® PPS
- ERTALON®
- NYLATRON®
- ERTACETAL®



# ADVANTAGES OF ENGINEERING PLASTICS



**LOW WEIGHT/  
DENSITY**



**THERMAL  
INSULATION**



**FDA/EU APPROVAL**  
FOR **FOOD CONTACT**  
ACC. (EU) 10/2011



**IMPACT  
RESISTANCE**



**ACOUSTIC  
INSULATION**



**ELECTRICAL  
INSULATION**



**CORROSION  
RESISTANCE**



**FLAME  
RETARDATION**



**DOESN'T NEED  
PAINTING**



**WEAR  
RESISTANCE**



**EXCELLENT  
SLIDING  
PROPERTIES**



**LUBRICATION  
FREE**



# INDEX

## HIGH PERFORMANCE PLASTICS

Duratron® PAI T4203/T4503	24
Duratron® PAI T4301/T4501	25
Duratron® CU60 PBI	26
Duratron® PEI 1000	27
Fluorosint® 207	30
Fluorosint® 500	31
Ketron® PEEK 1000	34
Ketron® PEEK HPV	35
Ketron® PEEK GF30	36
Ketron® PEEK CA30	37
PSU 1000	40
PVDF 1000	42
Semitron® ESd 500HR	44
Semitron® ESd 520HR	45
Semitron® ESd 410C	46
Techtron® HPV PPS	48

## ERTALYTE®

### PET

Ertalyte®	58
Ertalyte® TX	59

## ERTALON®/ NYLATRON®

### PA

Ertalon® 6 SA	72
Ertalon® 66 SA	73
Ertalon® 4.6	74
Ertalon® 66 GF30	75
Ertalon® 6 PLA	76
Ertalon® 6 XAU+	77
Ertalon® LFX	78
Nylatron® GS	84
Nylatron® GSM	85
Nylatron® NSM	86
Nylatron® MC 901	87
Nylatron® SLG	88
Nylatron® 703 XL	89

## ERTACETAL®/ACETRON®

### POM

Ertacetal® C	104
Ertacetal® H	105
Acetron® MD	108
Poly-ESD	110

## TIVAR®

### PE

PE-HD	122
Tivar® Tech	125
Tivar® Ceram P	126
Tivar® Cestidur/DS	127
Tivar® H.O.T.	128
Tivar® SuperPlus	129
Tivar® 1000	130
Tivar® 1000 EC	131
Tivar® 1000 TG1	132
Tivar® 1000 Antistatic	133
Tivar® 1000 ASTL	134
Tivar® Dryslide	135
Tivar® QuickSilver	136
Tivar® 88	137
Perfis Standard	153
Guias de deslizamento	159
Fusos e Estrelas	162

## PC 1000

### PC

PC 1000	166
---------	-----

## GENERAL USE PLASTICS

Polipropileno Natural	176
Polipropileno Grey	177
Poliuretano	180
PVC	182
TPE	184
PTFE	186

## COMPOSITES

Baquelite	194
Celeron	196
Tervid EP 155F	198
Tervid EP 180H	199
Mikla 990	200

# INTRODUCTION TO ENGINEERING PLASTICS

Engineering Plastics are polymers that exhibit excellent mechanical properties (strength, creep resistance, impact resistance, fatigue resistance and wear resistance) over a wide temperature range. They are, therefore, particularly suitable for the manufacturing of structural parts and machines where they replace other building materials, mainly metals. In addition, they often also have good chemical resistance and excellent electrical insulation capability.

## ADVANTAGES OF ENGINEERING PLASTICS IN COMPARISON WITH METALS

- Low density and high specific resistance (resistance/weight ratio)
- Chemical resistance
- Corrosion resistance
- Thermal and electrical insulation
- Flexibility of design
- Easily mouldable
- Available in several colours
- Reduced total cost of energy

## PYRAMID OF PERFORMANCES

TEMPERATURE | CHEMISTRY | FORCE

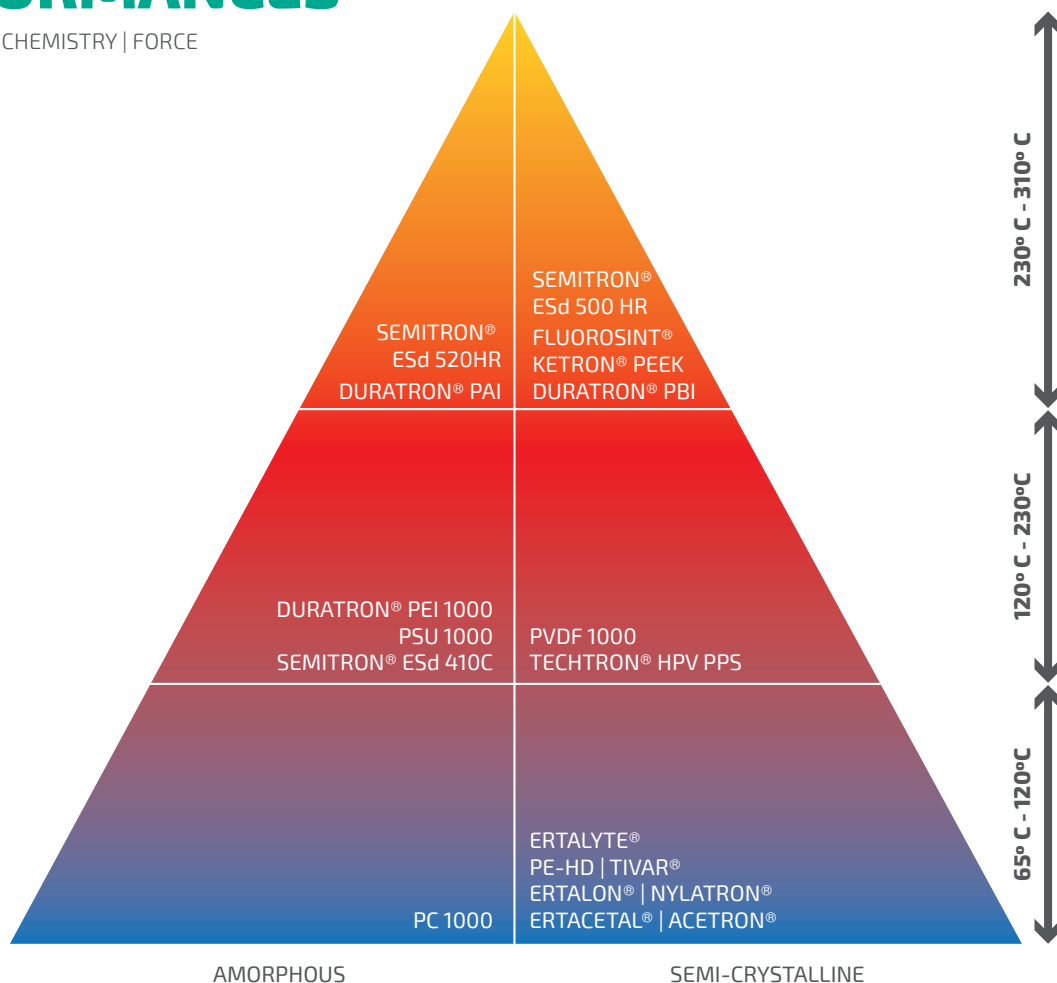

## AMORPHOUS PLASTICS

The term "amorphous" means that the molecular structure has no internal order. The layout is like the messy structure of a piece of cotton (or a dish of spaghetti). In general, amorphous thermoplastics are stable, hard and brittle at 20°C.

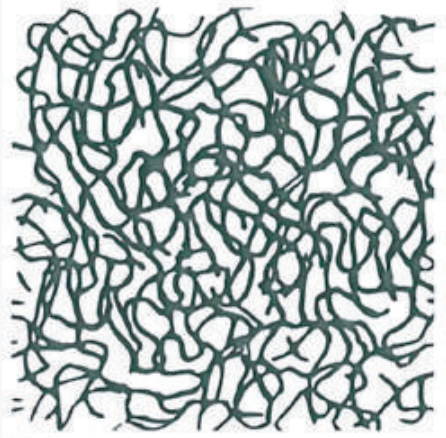

**Molecular structure of amorphous plastics:**  
molecules in a solid are tangled

- Not suitable for dynamic applications
- Excellent dimensional stability
- Excellent bonding and welding characteristics
- Stable mechanical properties up to a given temperature (T<sub>g</sub>)
- Thermoform capability
- High toughness
- Poor resilience characteristics
- Sensitive to stress drop
- Resistance to temperatures up to 200°C (high performance plastics)

## SEMI-CRYSTALLINE PLASTICS

Semi-crystalline plastics are of amorphous structure at certain temperatures, but in others, the molecules take a definite order. This grouped molecular structure is known as crystalline, which has a higher density than the amorphous structures. The physical bonding forces are larger in the crystalline range. Semi-crystalline plastics are resistant, stable and hard at room temperature



**Molecular structure of semi-crystalline plastics:**  
solid molecules have a partially crystalline structure

- Suitable for dynamic and static applications
- Better chemical resistance
- Difficult to bond and weld
- Resistance to temperatures up to 120°C (250°C in high performance plastics)
- Excellent abrasion resistance (TIVAR®)
- Use at temperature below -200°C (TIVAR®)
- Specific additives (Nylatron® GSM, MC901, Ertalon® 6XAU +) that have improved resistance to temperature and wear and frictional behaviour
- Specific fibreglass additives (Ertalon® 66 GF30) that have improved mechanical (static) resistance and dimensional stability
- Specific additives such as lubricants (Ertalon® LFX; Nylatron® NSM, 703XL; Ertalyte® TX) that have improved wear and frictional behaviour and in turn, PV values (frictional heat)
- Very good chemical resistance (Fluorosint® / Ketron® / Techtron®)

## THE HIGHER THE DEGREE OF CRYSTALLINITY

### IT INCREASES

- Density
- Stiffness (elasticity module)
- Elastic limit stress
- Hardness
- Creep resistance
- Dimensional stability
- Wear resistance
- Ageing resistance
- Chemical resistance

### IT DECREASES

- Impact force
- Stretching in rupture
- Mechanical damping capacity
- Moisture absorption
- Thermal expansion
- Permeability



# HOW TO CHOOSE THE SUITABLE PLASTIC?

Poly Lanema offers an extensive range of engineering plastics. For a correct selection of the material, the context of the application must be considered and, in turn, several factors such as: temperature, loads, chemical resistance, food contact, among others.



## 1. TYPE OF APPLICATION

### STATIC – STRUCTURAL

#### ALL PLASTICS CAN BE CONSIDERED

The choice should be made based on:

- Strength
- Stiffness (allowed deformation)
- Load time
- Temperature

These can be improved with additives such as:

- Carbon fibres
- Glass fibres

### DYNAMICS - WEAR

#### USE ONLY SEMI-CRYSTALLINE PLASTICS

It should be considered:

- Wear rate
- Coefficient of friction
- Pressure-Speed (PV) Capacities

These can be improved with internal lubricants such as:

- Carbon fibres
- Graphite
- MoS<sub>2</sub>
- PTFE
- Wax
- Oil

It should be noted that the coefficient of friction, the wear rate, and the PV values are not properties of the material but rather properties of the system. The wear and frictional behaviour of plastics are so complex that it is impossible to provide exact and generally applicable wear factors and coefficients of friction. The main parameters that affect the wear rate and the coefficient of friction are:

- Pressure and temperature
- Relative sliding speed
- Geometry of other parts in contact
- Nature, roughness and hardness of the metal coupling surface
- Total operating time
- Nature of any intermediate medium (e.g. water, lubricants, abrasive particles, among others)

## 2. TEMPERATURE



### AMORPHOUS PLASTICS

PLASTICS	MAXIMUM TEMPERATURE CONTINUOUSLY	MAXIMUM TEMPERATURE SHORT PERIODS	MINIMUM TEMPERATURE	PAGE
Duratron® PAI T4203/T4503	250°	270°	-50°	24
Duratron® PAI T4301/T4501	250°	270°	-20°	25
Duratron® PEI 1000	170°	200°	-50°	27
PSU 1000	150°	180°	-50°	40
Semitron® ESd 410C	170°	200°	-20°	46
PC 1000	120°	135°	-50°	166

### SEMI-CRYSTALLINE PLASTICS

PLASTICS	MAXIMUM TEMPERATURE CONTINUOUSLY	MAXIMUM TEMPERATURE SHORT PERIODS	MINIMUM TEMPERATURE	PAGE
Duratron® CU60 PBI	310°	500°	-50°	26
Fluorosint® 207	260°	280°	-50°	30
Fluorosint® 500	260°	280°	-20°	31
Ketron® PEEK 1000	250°	310°	-50°	34
Ketron® PEEK HPV	250°	310°	-20°	35
Ketron® PEEK GF30	250°	310°	-20°	36
Ketron® PEEK CA30	250°	310°	-20°	37
PVDF 1000	150°	-	-30°	42
Semitron® ESd 500HR	260°	280°	-50°	44
Semitron® ESd 520HR	250°	270°	-20°	45
Techtron® HPV PPS	220°	260°	-20°	48
Ertalyte®	100°	160°	-20°	58
Ertalyte® TX	100°	160°	-20°	59
Ertalon® 6 SA	70°	160°	-40°	72
Ertalon® 66 SA	80°	180°	-30°	73
Ertalon® 4.6	130°	200°	-40°	74
Ertalon® 66 GF30	110°	200°	-20°	75
Ertalon® 6 PLA	90°	170°	-30°	76
Ertalon® 6 XAU+	105°	180°	-30°	77
Ertalon® LFX	90°	165°	-20°	78
Nylatron® GS	80°	180°	-20°	84
Nylatron® GSM	90°	170°	-30°	85
Nylatron® NSM	90°	165°	-30°	86
Nylatron® MC 901	90°	170°	-30°	87
Nylatron® SLG	90°	165°	-20°	88
Nylatron® 703 XL	90°	160°	-20°	89
Ertacetal® C	100°	140°	-50°	104
Ertacetal® H	90°	150°	-50°	105
Acetron® MD	90°	140°	-30°	108
Poly-ESD	100°	140°	-	110
PE - HD	80°	120°	-100°	122
Tivar® Tech	80°	120°	-150°	125
Tivar® Ceram P	80°	120°	-150°	126
Tivar® Cestidur/DS	80°	120°	-200°	127
Tivar® H.O.T.	110°	135°	-200°	128
Tivar® SuperPlus	80°	120°	-150°	129
Tivar® 1000	80°	120°	-200°	130
Tivar® 1000 EC	80°	120°	-150°	131
Tivar® 1000 TG1	80°	120°	-200°	132
Tivar® 1000 Antistatic	80°	120°	-150°	133
Tivar® 1000 ASTL	80°	120°	-150°	134
Tivar® DrySlide	80°	120°	-150°	135
Tivar® QuickSilver	80°	120°	-150°	136
Tivar® 88	80°	90°	-200°	137

## 3. ELECTRICAL INSULATION



### AMORPHOUS PLASTICS

PLASTICS	ELECTRICAL INSULATION	AVAILABLE FORMATS	PAGE
Duratron® PAI T4203/T4503	Good	■●○	24
Duratron® PAI T4301/T4501	Good	■●○	25
Duratron® PEI 1000	Good	■●	27
PSU 1000	Excellent	■●	40
Semitron® ESd 410C	Good	■●	46
PC 1000	Fair	■●	166

### SEMI-CRYSTALLINE PLASTICS

PLASTICS	ELECTRICAL INSULATION	AVAILABLE FORMATS	PAGE
Duratron® CU60 PBI	Good	■●	26
Fluorosint® 207	Good	■●○	30
Fluorosint® 500	Good	■●○	31
Ketron® PEEK 1000	Good	■●○	34
Ketron® PEEK HPV	Good	■●○	35
Ketron® PEEK GF30	Good	■●○	36
Ketron® PEEK CA30	Good	■●○	37
PVDF 1000	Good	■●	42
Semitron® ESd 500HR	Good	■	44
Semitron® ESd 520HR	Good	■	45
Techtron® HPV PPS	Good	■●	48
Ertalyte®	Fair	—■●○	58
Ertalyte® TX	Fair	■●○	59
Ertalon® 6 SA	Good	—■●○	72
Ertalon® 66 SA	Good	—■●○	73
Ertalon® 4.6	Good	■●	74
Ertalon® 66 GF30	Good	■●	75
Ertalon® 6 PLA	Good	■●○	76
Ertalon® 6 XAU+	Good	■●○	77
Ertalon® LFX	Good	■●○	78
Nylatron® GS	Good	■●○	84
Nylatron® GSM	Good	■●○	85
Nylatron® NSM	Good	■●○	86
Nylatron® MC 901	Good	■●○	87
Nylatron® SLG	Good	■	88
Nylatron® 703 XL	Good	■	89
Ertacetal® C	Fair	—■●○	104
Ertacetal® H	Fair	■●	105
Acetron® MD	Fair	■●	108
Poly-ESD	Fair	■	110
PE - HD	Good	—■●	122
Tivar® Tech	Good	—■	125
Tivar® Ceram P	Good	—■	126
Tivar® Cestidur/DS	Good	—■●	127
Tivar® H.O.T.	Good	—■	128
Tivar® SuperPlus	Good	■	129
Tivar® 1000	Good	—■●	130
Tivar® 1000 EC	Fair	—■	131
Tivar® 1000 TG1	Good	■	132
Tivar® 1000 Antistatic	Good	—■	133
Tivar® 1000 ASTL	Good	—■●	134
Tivar® DrySlide	Good	—■	135
Tivar® QuickSilver	Good	—■	136
Tivar® 88	Good	—■	137

## 4. FOOD CONTACT



### AMORPHOUS PLASTICS

PLASTICS	UE ACC. (EU) 10/2011	USA FDA (21 CFR)	PAGE
Duratron® PAI T4203/T4503	No	No	24
Duratron® PAI T4301/T4501	No	No	25
Duratron® PEI 1000	No	Yes	27
PSU 1000	No	Yes	40
Semitron® ESd 410C	No	No	46
PC 1000	Yes	Yes	166

### SEMI-CRYSTALLINE PLASTICS

PLASTICS	UE ACC. (EU) 10/2011	USA FDA (21 CFR)	PAGE
Duratron® CU60 PBI	No	No	26
Fluorosint® 207	No	Yes	30
Fluorosint® 500	No	No	31
Ketron® PEEK 1000	Yes	Yes	34
Ketron® PEEK HPV	No	No	35
Ketron® PEEK GF30	No	No	36
Ketron® PEEK CA30	No	No	37
PVDF 1000	Yes	Yes	42
Semitron® ESd 500HR	No	No	44
Semitron® ESd 520HR	No	No	45
Techtron® HPV PPS	Yes	Yes	48
Ertalyte®	Yes	Yes (Natural)	58
Ertalyte® TX	Yes	Yes	59
Ertalon® 6 SA	Yes (Natural)	Yes (Natural)	72
Ertalon® 66 SA	Yes (Natural)	Yes (Natural)	73
Ertalon® 4.6	No	No	74
Ertalon® 66 GF30	No	No	75
Ertalon® 6 PLA	Yes (Natural/Blue)	Yes (Natural/Azul)	76
Ertalon® 6 XAU+	No	No	77
Ertalon® LFX	No	No	78
Nylatron® GS	No	No	84
Nylatron® GSM	No	No	85
Nylatron® NSM	No	No	86
Nylatron® MC 901	No	No	87
Nylatron® SLG	No	No	88
Nylatron® 703 XL	No	No	89
Ertacetal® C	Yes (Natural/Black/Blue)	Yes (Natural/Black/Blue)	104
Ertacetal® H	No	No	105
Acetron® MD	Yes	Yes	108
Poly-ESD	Não	No	110
PE - HD	Yes (Natural/Green/Blue)	Yes (Natural, Blue, Yellow, Red)	122
Tivar® Tech	Yes	No	125
Tivar® Ceram P	No	No	126
Tivar® Cestidur/DS	Yes	Yes	127
Tivar® H.O.T.	Yes	Yes	128
Tivar® SuperPlus	No	No	129
Tivar® 1000	Yes (Natural/Green/Blue)	Yes (Natural, Blue, Yellow, Red)	130
Tivar® 1000 EC	Yes	Yes	131
Tivar® 1000 TG1	No	No	132
Tivar® 1000 Antistatic	Yes	No	133
Tivar® 1000 ASTL	Yes	No	134
Tivar® DrySlide	No	No	135
Tivar® QuickSilver	No	No	136
Tivar® 88	No	No	137

## 5. CHEMICAL RESISTANCE



### AMORPHOUS PLASTICS

PLASTICS	CHEMICAL RESISTANCE	AVAILABLE FORMATS	PAGE
Duratron® PAI T4203/T4503	Good	■●○	24
Duratron® PAI T4301/T4501	Good	■●○	25
Duratron® PEI 1000	Good	■●	27
PSU 1000	Good	■●	40
Semitron® ESd 410C	Good	■●	46
PC 1000	Good	■●	166

### SEMI-CRYSTALLINE PLASTICS

PLASTICS	CHEMICAL RESISTANCE	AVAILABLE FORMATS	PAGE
Duratron® CU60 PBI	Good	■●	26
Fluorosint® 207	Excellent	■●○	30
Fluorosint® 500	Excellent	■●○	31
Ketron® PEEK 1000	Excellent	■●○	34
Ketron® PEEK HPV	Excellent	■●○	35
Ketron® PEEK GF30	Excellent	■●○	36
Ketron® PEEK CA30	Excellent	■●○	37
PVDF 1000	Excellent	■●	42
Semitron® ESd 500HR	Good	■	44
Semitron® ESd 520HR	Good	■	45
Techtron® HPV PPS	Excellent	■●	48
Ertalyte®	Good	—■●○	58
Ertalyte® TX	Good	■●○	59
Ertalon® 6 SA	Fair	—■●○	72
Ertalon® 66 SA	Fair	—■●○	73
Ertalon® 4.6	Fair	■●	74
Ertalon® 66 GF30	Fair	■●	75
Ertalon® 6 PLA	Fair	■●○	76
Ertalon® 6 XAU+	Fair	■●○	77
Ertalon® LFX	Fair	■●○	78
Nylatron® GS	Fair	■●○	84
Nylatron® GSM	Fair	■●○	85
Nylatron® NSM	Fair	■●○	86
Nylatron® MC 901	Fair	■●○	87
Nylatron® SLG	Fair	■	88
Nylatron® 703 XL	Fair	■	89
Ertacetal® C	Good	—■●○	104
Ertacetal® H	Fair	■●	105
Acetron® MD	Fair	■●	108
Poly-ESD	Fair	■	110
PE - HD	Good	—■●	122
Tivar® Tech	Excellent	—■	125
Tivar® Ceram P	Good	—■	126
Tivar® Cestidur/DS	Good	—■●	127
Tivar® H.O.T.	Good	—■	128
Tivar® SuperPlus	Excellent	■	129
Tivar® 1000	Excellent	—■●	130
Tivar® 1000 EC	Excellent	—■	131
Tivar® 1000 TG1	Excellent	■	132
Tivar® 1000 Antistatic	Excellent	—■	133
Tivar® 1000 ASTL	Good	—■●	134
Tivar® DrySlide	Good	—■	135
Tivar® QuickSilver	Good	—■	136
Tivar® 88	Good	—■	137



## 6. WEAR RESISTANCE

### AMORPHOUS PLASTICS



PLASTICS	WEAR RESISTANCE	AVAILABLE FORMATS	PAGE
Duratron® PAI T4203/T4503	Good	■●○	24
Duratron® PAI T4301/T4501	Good	■●○	25
Duratron® PEI 1000	Good	■●	27
PSU 1000	Good	■●	40
Semitron® ESd 410C	Good	■●	46
PC 1000	Fair	■●	166

### SEMI-CRYSTALLINE PLASTICS

PLASTICS	WEAR RESISTANCE	AVAILABLE FORMATS	PAGE
Duratron® CU60 PBI	Excellent	■●	26
Fluorosint® 207	Good	■●○	30
Fluorosint® 500	Good	■●○	31
Ketron® PEEK 1000	Excellent	■●○	34
Ketron® PEEK HPV	Excellent	■●○	35
Ketron® PEEK GF30	Excellent	■●○	36
Ketron® PEEK CA30	Excellent	■●○	37
PVDF 1000	Good	■●	42
Semitron® ESd 500HR	Good	■	44
Semitron® ESd 520HR	Good	■	45
Techtron® HPV PPS	Excellent	■●	48
Ertalyte®	Good	—■●○	58
Ertalyte® TX	Excellent	■●○	59
Ertalon® 6 SA	Good	—■●○	72
Ertalon® 66 SA	Good	—■●○	73
Ertalon® 4.6	Excellent	■●	74
Ertalon® 66 GF30	Excellent	■●	75
Ertalon® 6 PLA	Good	■●○	76
Ertalon® 6 XAU+	Excellent	■●○	77
Ertalon® LFX	Excellent	■●○	78
Nylatron® GS	Excellent	■●○	84
Nylatron® GSM	Excellent	■●○	85
Nylatron® NSM	Excellent	■●○	86
Nylatron® MC 901	Excellent	■●○	87
Nylatron® SLG	Excellent	■	88
Nylatron® 703 XL	Excellent	■	89
Ertacetal® C	Good	—■●○	104
Ertacetal® H	Good	■●	105
Acetron® MD	Good	■●	108
Poly-ESD	Good	■	110
PE - HD	Fair	—■●	122
Tivar® Tech	Excellent	—■	125
Tivar® Ceram P	Excellent	—■	126
Tivar® Cestidur/DS	Excellent	—■●	127
Tivar® H.O.T.	Good	—■	128
Tivar® SuperPlus	Excellent	■	129
Tivar® 1000	Good	—■●	130
Tivar® 1000 EC	Good	—■	131
Tivar® 1000 TG1	Excellent	■	132
Tivar® 1000 Antistatic	Good	—■	133
Tivar® 1000 ASTL	Good	—■●	134
Tivar® DrySlide	Excellent	—■	135
Tivar® QuickSilver	Excellent	—■	136
Tivar® 88	Excellent	—■	137

— FOLHA ■ PLACA ● BARRA REDONDA ○ TUBO

## 7. IMPACT RESISTANCE

### AMORPHOUS PLASTICS



PLÁSTICOS	IMPACT RESISTANCE	AVAILABLE FORMATS	PAGE
Duratron® PAI T4203/T4503	Fair	■●○	24
Duratron® PAI T4301/T4501	Fair	■●○	25
Duratron® PEI 1000	Fair	■●	27
PSU 1000	Fair	■●	40
Semitron® ESd 410C	Fair	■●	46
PC 1000	Excellent	■●	166

### SEMI-CRYSTALLINE PLASTICS

PLASTICS	IMPACT RESISTANCE	AVAILABLE FORMATS	PAGE
Duratron® CU60 PBI	Fair	■●	26
Fluorosint® 207	Fair	■●○	30
Fluorosint® 500	Fair	■●○	31
Ketron® PEEK 1000	Fair	■●○	34
Ketron® PEEK HPV	Fair	■●○	35
Ketron® PEEK GF30	Fair	■●○	36
Ketron® PEEK CA30	Fair	■●○	37
PVDF 1000	Good	■●	42
Semitron® ESd 500HR	Fair	■	44
Semitron® ESd 520HR	Fair	■	45
Techtron® HPV PPS	Fair	■●	48
Ertalyte®	Poor	—■●○	58
Ertalyte® TX	Poor	■●○	59
Ertalon® 6 SA	Good	—■●○	72
Ertalon® 66 SA	Fair	—■●○	73
Ertalon® 4.6	Bom	■●	74
Ertalon® 66 GF30	Fair	■●	75
Ertalon® 6 PLA	Good	■●○	76
Ertalon® 6 XAU+	Good	■●○	77
Ertalon® LFX	Good	■●○	78
Nylatron® GS	Good	■●○	84
Nylatron® GSM	Good	■●○	85
Nylatron® NSM	Good	■●○	86
Nylatron® MC 901	Excellent	■●○	87
Nylatron® SLG	Good	■	88
Nylatron® 703 XL	Good	■	89
Ertacetal® C	Good	—■●○	104
Ertacetal® H	Good	■●	105
Acetron® MD	Good	■●	108
Poly-ESD	Good	■	110
PE - HD	Good	—■●	122
Tivar® Tech	Excellent	—■	125
Tivar® Ceram P	Good	—■	126
Tivar® Cestidur/DS	Good	—■●	127
Tivar® H.O.T.	Good	—■	128
Tivar® SuperPlus	Good	■	129
Tivar® 1000	Excellent	—■●	130
Tivar® 1000 EC	Good	—■	131
Tivar® 1000 TG1	Excellent	■	132
Tivar® 1000 Antistatic	Good	—■	133
Tivar® 1000 ASTL	Good	—■●	134
Tivar® DrySlide	Excellent	—■	135
Tivar® QuickSilver	Excellent	—■	136
Tivar® 88	Excellent	—■	137

## 8. SLIDING PROPERTIES

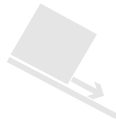

### AMORPHOUS PLASTICS

PLASTICS	SLIDING PROPERTIES	AVAILABLE FORMATS	PAGE
Duratron® PAI T4203/T4503	Fair	■●○	24
Duratron® PAI T4301/T4501	Good	■●○	25
Duratron® PEI 1000	Good	■●	27
PSU 1000	Fair	■●	40
Semitron® ESd 410C	Fair	■●	46
PC 1000	Fair	■●	166

### SEMI-CRYSTALLINE PLASTICS

PLASTICS	SLIDING PROPERTIES	AVAILABLE FORMATS	PAGE
Duratron® CU60 PBI	Good	■●	26
Fluorosint® 207	Excellent	■●○	30
Fluorosint® 500	Good	■●○	31
Ketron® PEEK 1000	Excellent	■●○	34
Ketron® PEEK HPV	Excellent	■●○	35
Ketron® PEEK GF30	Good	■●○	36
Ketron® PEEK CA30	Excellent	■●○	37
PVDF 1000	Good	■●	42
Semitron® ESd 500HR	Fair	■	44
Semitron® ESd 520HR	Fair	■	45
Techtron® HPV PPS	Excellent	■●	48
Ertalyte®	Good	—■●○	58
Ertalyte® TX	Excellent	■●○	59
Ertalon® 6 SA	Good	—■●○	72
Ertalon® 66 SA	Good	—■●○	73
Ertalon® 4.6	Good	■●	74
Ertalon® 66 GF30	Good	■●	75
Ertalon® 6 PLA	Good	■●○	76
Ertalon® 6 XAU+	Good	■●○	77
Ertalon® LFX	Excellent	■●○	78
Nylatron® GS	Good	■●○	84
Nylatron® GSM	Excellent	■●○	85
Nylatron® NSM	Excellent	■●○	86
Nylatron® MC 901	Good	■●○	87
Nylatron® SLG	Good	■	88
Nylatron® 703 XL	Excellent	■	89
Ertacetal® C	Good	—■●○	104
Ertacetal® H	Fair	■●	105
Acetron® MD	Good	■●	108
Poly-ESD	Good	■	110
PE - HD	Good	—■●	122
Tivar® Tech	Excellent	—■	125
Tivar® Ceram P	Good	—■	126
Tivar® Cestidur/DS	Excellent	—■●	127
Tivar® H.O.T.	Good	—■	128
Tivar® SuperPlus	Excellent	■	129
Tivar® 1000	Good	—■●	130
Tivar® 1000 EC	Good	—■	131
Tivar® 1000 TG1	Excellent	■	132
Tivar® 1000 Antistatic	Good	—■	133
Tivar® 1000 ASTL	Good	—■●	134
Tivar® DrySlide	Excellent	—■	135
Tivar® QuickSilver	Excellent	—■	136
Tivar® 88	Excellent	—■	137

## 9. WATER ABSORPTION

(AT SATURATION IN WATER OF 23°)



### AMORPHOUS PLASTICS

PLASTICS	WATER ABSORPTION	AVAILABLE FORMATS	PAGE
Duratron® PAI T4203/T4503	4.4 %	■●○	24
Duratron® PAI T4301/T4501	3.8 %	■●○	25
Duratron® PEI 1000	1.3 %	■●	27
PSU 1000	0.80 %	■●	40
Semitron® ESd 410C	1.10 %	■●	46
PC 1000	0.40 %	■●	166

### SEMI-CRYSTALLINE PLASTICS

PLASTICS	WATER ABSORPTION	AVAILABLE FORMATS	PAGE
Duratron® CU60 PBI	14 %	■●	26
Fluorosint® 207	1 - 2 %	■●○	30
Fluorosint® 500	1.5 - 2.5 %	■●○	31
Ketron® PEEK 1000	0.45 %	■●○	34
Ketron® PEEK HPV	0.35 %	■●○	35
Ketron® PEEK GF30	0.35 %	■●○	36
Ketron® PEEK CA30	0.35 %	■●○	37
PVDF 1000	0.04 %	■●	42
Semitron® ESd 500HR	1-2 %	■	44
Semitron® ESd 520HR	4.6 %	■	45
Techtron® HPV PPS	0.20 %	■●	48
Ertalyte®	0.50 %	—■●○	58
Ertalyte® TX	0.47 %	■●○	59
Ertalon® 6 SA	9 %	—■●○	72
Ertalon® 66 SA	8 %	—■●○	73
Ertalon® 4.6	9.5 %	■●	74
Ertalon® 66 GF30	5.5 %	■●	75
Ertalon® 6 PLA	6.5 %	■●○	76
Ertalon® 6 XAU+	6.5 %	■●○	77
Ertalon® LFX	6.3 %	■●○	78
Nylatron® GS	7.8 %	■●○	84
Nylatron® GSM	6.7 %	■●○	85
Nylatron® NSM	6.3 %	■●○	86
Nylatron® MC 901	6.6 %	■●○	87
Nylatron® SLG	6.3 %	■	88
Nylatron® 703 XL	6.3 %	■	89
Ertacetal® C	0.80 %	—■●○	104
Ertacetal® H	0.80 %	■●	105
Acetron® MD	0.75 %	■●	108
Poly-ESD	0.80 %	■	110
PE - HD	<0.1 %	—■●	122
Tivar® Tech	<0.1 %	—■	125
Tivar® Ceram P	< 0.1 %	—■	126
Tivar® Cestidur/DS	< 0.1%/0.01%	—■●	127
Tivar® H.O.T.	< 0.1 %	—■	128
Tivar® SuperPlus	< 0.1 %	■	129
Tivar® 1000	< 0.1 %	—■●	130
Tivar® 1000 EC	< 0.1 %	—■	131
Tivar® 1000 TG1	< 0.1 %	■	132
Tivar® 1000 Antistatic	< 0.1 %	—■	133
Tivar® 1000 ASTL	< 0.1 %	—■●	134
Tivar® DrySlide	< 0.1 %	—■	135
Tivar® QuickSilver	< 0.1 %	—■	136
Tivar® 88	< 0.1 %	—■	137



# 10. FLAMMABILITY



## AMORPHOUS PLASTICS

PLASTICS	OXYGEN INDEX	AVAILABLE FORMATS	PAGE
Duratron® PAI T4203/T4503	45 %	■●○	24
Duratron® PAI T4301/T4501	44 %	■●○	25
Duratron® PEI 1000	47 %	■●	27
PSU 1000	30 %	■●	40
Semitron® ESd 410C	47 %	■●	46
PC 1000	25 %	■●	166

## SEMI-CRYSTALLINE PLASTICS

PLASTICS	OXYGEN INDEX	AVAILABLE FORMATS	PAGE
Duratron® CU60 PBI	58 %	■●	26
Fluorosint® 207	≥ 95 %	■●○	30
Fluorosint® 500	≥ 95 %	■●○	31
Ketron® PEEK 1000	35 %	■●○	34
Ketron® PEEK HPV	43 %	■●○	35
Ketron® PEEK GF30	40 %	■●○	36
Ketron® PEEK CA30	40 %	■●○	37
PVDF 1000	44 %	■●	42
Semitron® ESd 500HR	≥ 95 %	■	44
Semitron® ESd 520HR	48 %	■	45
Techtron® HPV PPS	44 %	■●	48
Ertalyte®	25 %	—■●○	58
Ertalyte® TX	25 %	■●○	59
Ertalon® 6 SA	25 %	—■●○	72
Ertalon® 66 SA	26 %	—■●○	73
Ertalon® 4.6	24 %	■●	74
Ertalon® 66 GF30	-	■●	75
Ertalon® 6 PLA	25 %	■●○	76
Ertalon® 6 XAU+	25 %	■●○	77
Ertalon® LFX	-	■●○	78
Nylatron® GS	26 %	■●○	84
Nylatron® GSM	25 %	■●○	85
Nylatron® NSM	-	■●○	86
Nylatron® MC 901	25 %	■●○	87
Nylatron® SLG	-	■	88
Nylatron® 703 XL	< 20 %	■	89
Ertacetal® C	15 %	—■●○	104
Ertacetal® H	15 %	■●	105
Acetron® MD	< 20 %	■●	108
Poly-ESD	-	■	110
PE - HD	< 20 %	—■●	122
Tivar® Tech	< 20 %	—■	125
Tivar® Ceram P	< 20 %	—■	126
Tivar® Cestidur/DS	< 20 %	—■●	127
Tivar® H.O.T.	< 20 %	—■	128
Tivar® SuperPlus	< 20 %	■	129
Tivar® 1000	< 20 %	—■●	130
Tivar® 1000 EC	< 20 %	—■	131
Tivar® 1000 TG1	< 20 %	■	132
Tivar® 1000 Antistatic	< 20 %	—■	133
Tivar® 1000 ASTL	< 20 %	—■●	134
Tivar® DrySlide	< 20 %	—■	135
Tivar® QuickSilver	< 20 %	—■	136
Tivar® 88	< 20 %	—■	137

— FOLHA ■ PLACA ● BARRA REDONDA ○ TUBO

# 11. COLOR



## AMORPHOUS PLASTICS

PLASTICS	COLOR	AVAILABLE FORMATS	PAGE
Duratron® PAI T4203/T4503	Yellow Ochre	■●○	24
Duratron® PAI T4301/T4501	Black	■●○	25
Duratron® PEI 1000	Amber Translucent	■●	27
PSU 1000	Amber Translucent	■●	40
Semitron® ESd 410C	Black	■●	46
PC 1000	Translucent	■●	166

## SEMI-CRYSTALLINE PLASTICS

PLASTICS	COLOR	AVAILABLE FORMATS	PAGE
Duratron® CU60 PBI	Black	■●	26
Fluorosint® 207	White	■●○	30
Fluorosint® 500	Ivory	■●○	31
Ketron® PEEK 1000	Beige/Black	■●○	34
Ketron® PEEK HPV	Black	■●○	35
Ketron® PEEK GF30	Beige	■●○	36
Ketron® PEEK CA30	Black	■●○	37
PVDF 1000	White	■●	42
Semitron® ESd 500HR	White	■	44
Semitron® ESd 520HR	Khaki Grey	■	45
Techtron® HPV PPS	Deep Blue	■●	48
Ertalyte®	White/Black	—■●○	58
Ertalyte® TX	Pale Grey	■●○	59
Ertalon® 6 SA	White/Black	—■●○	72
Ertalon® 66 SA	White/Black	—■●○	73
Ertalon® 4.6	Reddish Brown	■●	74
Ertalon® 66 GF30	Black	■●	75
Ertalon® 6 PLA	White/Black	■●○	76
Ertalon® 6 XAU+	Black	■●○	77
Ertalon® LFX	Green	■●○	78
Nylatron® GS	Grey-Black	■●○	84
Nylatron® GSM	Grey-Black	■●○	85
Nylatron® NSM	Grey	■●○	86
Nylatron® MC 901	Blue	■●○	87
Nylatron® SLG	Blue	■	88
Nylatron® 703 XL	Purple	■	89
Ertacetal® C	White/Black Other colors	—■●○	104
Ertacetal® H	White/Black	■●	105
Acetron® MD	Blue	■●	108
Poly-ESD	Black	■	110
PE - HD	White/Black Green/Other	—■●	122
Tivar® Tech	Grey-Black	—■	125
Tivar® Ceram P	Yellow-Green	—■	126
Tivar® Cestidur/DS	Grey/Yellow	—■●	127
Tivar® H.O.T.	White	—■	128
Tivar® SuperPlus	Grey	■	129
Tivar® 1000	White/Black Green/Other	—■●	130
Tivar® 1000 EC	Black	—■	131
Tivar® 1000 TG1	White/Black Green/Other	■	132
Tivar® 1000 Antistatic	Black	—■	133
Tivar® 1000 ASTL	Black	—■●	134
Tivar® DrySlide	Black	—■	135
Tivar® QuickSilver	Dark Grey	—■	136
Tivar® 88	Blue	—■	137

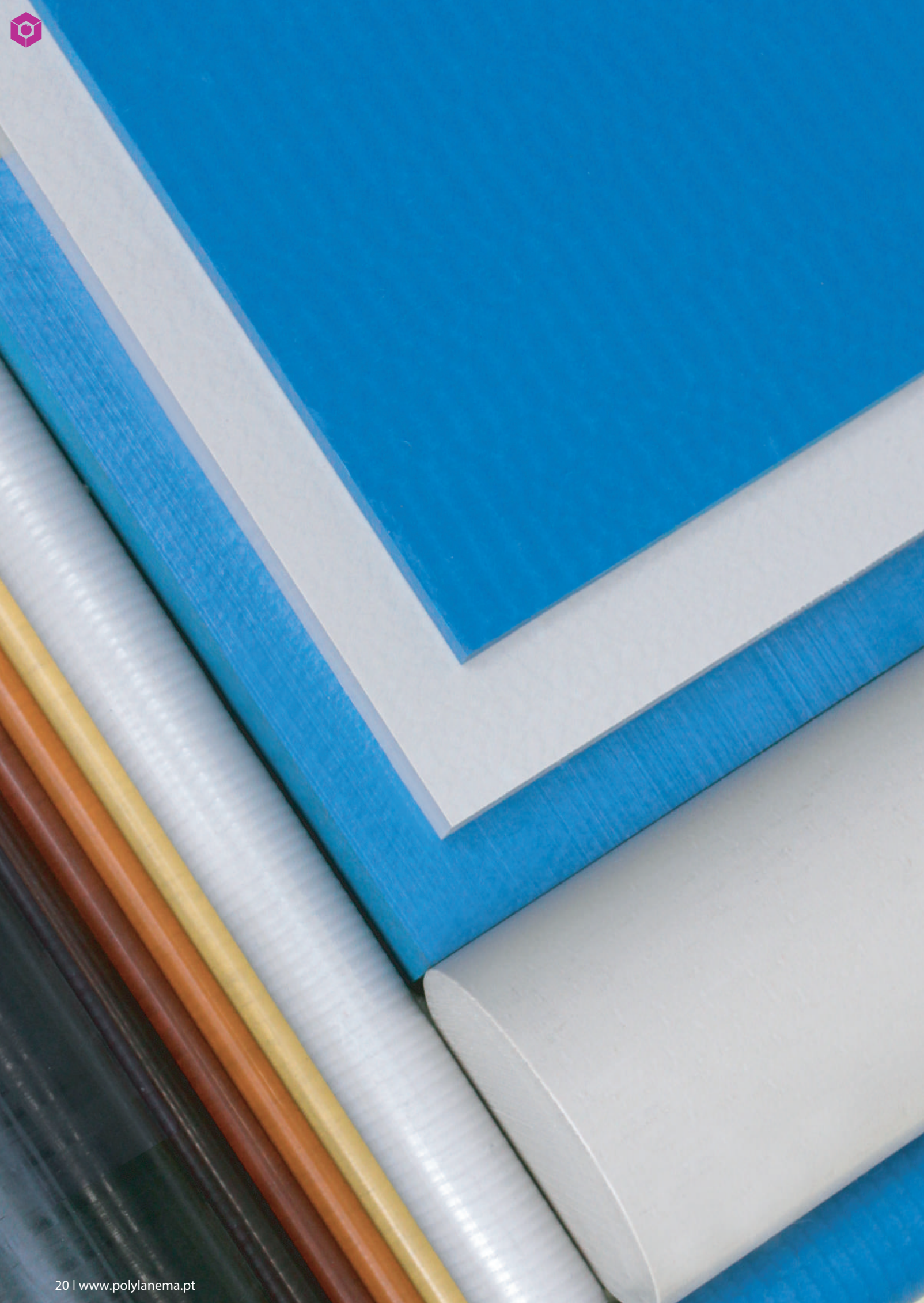



# HIGH PERFORMANCE PLASTICS

Duratron® PAI T4203/T4503		24
Duratron® PAI T4301/T4501		25
Duratron® CU60 PBI		26
Duratron® PEI 1000		27
Fluorosint® 207		30
Fluorosint® 500		31
Ketron® PEEK 1000		34
Ketron® PEEK HPV		35
Ketron® PEEK GF30		36
Ketron® PEEK CA30		37
PSU 1000		40
PVDF 1000		42
Semitron® ESd 500HR		44
Semitron® ESd 520HR		45
Semitron® ESd 410C		46
Techtron® HPV PPS		48
Technical Data		50

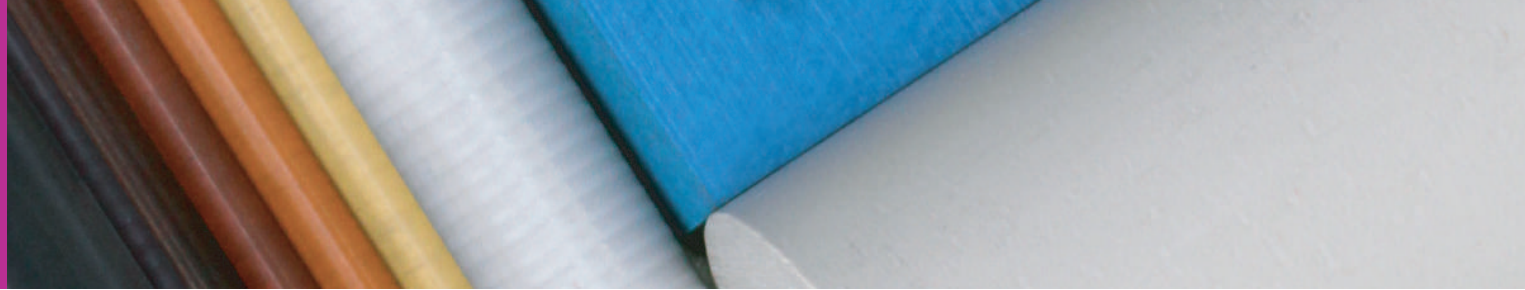

# INTRODUCTION TO HIGH PERFORMANCE PLASTICS

## ADVANTAGES OF HIGH-PERFORMANCE PLASTICS

- High service temperature (150°C in continuous service)
- Better stiffness retention and creep resistance over a wide temperature range
- Better dimensional stability
- Better chemical resistance
- Better hydrolysis resistance
- Better resistance to high radiation energy (x-rays and gamma rays)

## COMPOSITION OF HIGH-PERFORMANCE PLASTICS

Duratron® PAI	PAI	Polyamide-imide
Duratron® CU60 PBI	PBI	Polybenzimidazole
Fluorosint® 500	PTFE	Reinforced polytetrafluoroethylene
Ketron® PEEK	PEEK	Polyetheretherketone
PEI® 1000	PEI	Polyetherimide
PSU® 1000	PSU	Polysulfone
PVDF 1000	PVDF	Polyvinylidene fluoride
Semitron® ESd	-	Static dissipative plastics
Techtron® HPV PPS	PPS	Polyphenylene Sulphide

## CHEMICAL RESISTANCE

### KETRON® PEEK, TECHTRON® HPV PPS, PVDF 1000, FLUOROSINT®

- Excellent chemical resistance, approximate to PTFE
- Very good resistance to boiling water and steam (hydrolysis resistance)
- Resistance to halogenated hydrocarbons
- Partially resistant to strong oxidizing acids

# MAIN CHARACTERISTICS OF HIGH-PERFORMANCE PLASTICS

PLASTICS	IMPACT RESISTANCE	WEAR RESISTANCE	SLIDING PROPERTIES	CHEMICAL RESISTANCE	ELECTRICAL INSULATION	TEMPERATURE		
						MIN	MAX*	MAX**
DURATRON® CU60 PBI	FAIR	EXCELLENT	GOOD	GOOD	GOOD	-50°	310°	500°
DURATRON® T4203/T4503 PAI	FAIR	GOOD	FAIR	GOOD	GOOD	-50°	250°	270°
DURATRON® T4301/T4501 PAI	FAIR	GOOD	GOOD	GOOD	GOOD	-20°	250°	270°
DURATRON® PEI 1000	FAIR	GOOD	GOOD	GOOD	GOOD	-50°	170°	200°
FLUOROSINT® 207	FAIR	GOOD	EXCELLENT	EXCELLENT	GOOD	-50°	260°	280°
FLUOROSINT® 500	FAIR	GOOD	GOOD	EXCELLENT	GOOD	-20°	260°	280°
KETRON® PEEK 1000	FAIR	EXCELLENT	EXCELLENT	EXCELLENT	GOOD	-50°	250°	310°
KETRON® PEEK CA30	FAIR	EXCELLENT	EXCELLENT	EXCELLENT	GOOD	-20°	250°	310°
KETRON® PEEK GF30	FAIR	EXCELLENT	GOOD	EXCELLENT	GOOD	-20°	250°	310°
KETRON® PEEK HPV	FAIR	EXCELLENT	EXCELLENT	EXCELLENT	GOOD	-20°	250°	310°
PSU 1000	FAIR	GOOD	FAIR	GOOD	EXCELLENT	-50°	150°	180°
PVDF 1000	GOOD	GOOD	GOOD	EXCELLENT	GOOD	-30°	150°	-
SEMITRON® 410 C	FAIR	GOOD	FAIR	GOOD	GOOD	-20°	170°	200°
SEMITRON® ESd 500 HR	FAIR	GOOD	FAIR	GOOD	GOOD	-50°	260°	280°
SEMITRON® ESd 520 HR	FAIR	GOOD	FAIR	GOOD	GOOD	-20°	250°	270°
TECHTRON® HPV PPS	FAIR	EXCELLENT	EXCELLENT	EXCELLENT	GOOD	-20°	220°	260°

\*Continuously \*\*Short periods

## FOOD CONTACT



PLASTICS	UE ACC. (EU) 10/2011	USA Codigo FDA (21 CFR)	FOOD GRADE
DURATRON® CU60 PBI	NO	NO	NO
DURATRON® T4203/T4503 PAI	NO	NO	NO
DURATRON® T4301/T4501 PAI	NO	NO	NO
DURATRON® PEI 1000	NO	YES	NO
FLUOROSINT® 207	NO	YES	NO
FLUOROSINT® 500	NO	NO	NO
KETRON® PEEK 1000	YES	YES	YES
KETRON® PEEK CA30	NO	NO	NO
KETRON® PEEK GF30	NO	NO	NO
KETRON® PEEK HPV	NO	NO	NO
PSU 1000	NO	YES	NO
PVDF 1000	YES	YES	YES
SEMITRON® 410 C	NO	NO	NO
SEMITRON® ESd 500 HR	NO	NO	NO
SEMITRON® ESd 520 HR	NO	NO	NO
TECHTRON® HPV PPS	YES	YES	YES

## CHEMICAL RESISTANCE

CHEMICAL RESISTANCE AT 23°C	KETRON® PEEK				TECHTRON® HPV PPS	PSU 1000	PEI 1000	FLUOROSINT®		SEMITRON®		
	1000	HPV	CA30	GF30				207	500	410C	500HR	520HR
Weak acids (diluted)	+	+	+	+	+	+	+	+	+	+	+	+
Strong acids / Oxidizing chemicals	+ - / + -	+ - / + -	+ - / + -	+ - / + -	+ - / + -	+ - / + -	+ - / + -	+ - / + -	+ - / + -	+ - / + -	+ - / + -	+ - / + -
Weak alkalis (diluted)	+	+	+	+	+	+	+	+	+	+	+	+
Strong alkalis	+	+	+	+		+	+	+	+	+	+	+
Hot water (> 80°C) / Steam	+ / +	+ / +	+ / +	+ / +	+ / +	+ / +	+ / +	+ / +	+ / +	+ / +	+ / +	+ / +
Esters (e.g.: ethyl acetate)/Ketones (e.g.: acetone)	+ / +	+ / +	+ / +	+ / +	+ / +	+ / +	+ / +	+ / +	+ / +	+ / +	+ / +	+ / +
Aromatic hydrocarbons (e.g. benzene, toluene)	+	+	+	+	+	+	+	+	+	+	+	+
Aliphatic hydrocarbons (e.g. hexane, octane)	+	+	+	+	+	+	+	+	+	+	+	+
Lubricating oils and greases	+	+	+	+	+	+	+	+	+	+	+	+

+ Resistant (in general acceptable useful life)

± Partially resistant (limited useful life)

- Non-resistant



# DURATRON® PAI T4203 T4503

**Amorphous plastic,** DURATRON® T4203 PAI offers the best toughness and impact resistance of the entire DURATRON® PAI family. DURATRON® PAI is highly recommended for precision parts in high technology equipment. In addition, good electrical insulation capability offers numerous possibilities of applications in electrical components. DURATRON® T4503 PAI and DURATRON® T4203 PAI have similar characteristics, being complementary in terms of availability and manufacturing format.

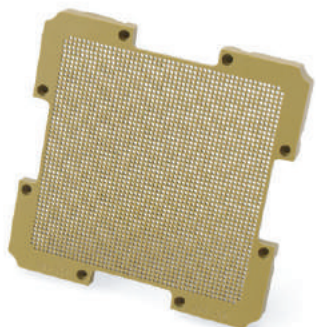
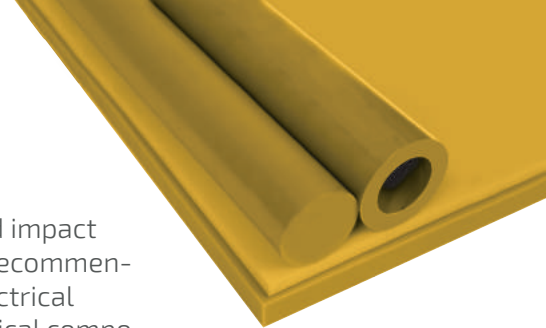

## MAIN CHARACTERISTICS

- High maximum service temperature in the air (250° C in continuous service)
- Excellent retention of mechanical resistance, stiffness and creep resistance over a wide range of temperatures
- Excellent dimensional stability up to 260°C
- Very good resistance to UV rays
- Exceptional resistance against high energy radiation (gamma rays and X-rays)
- Inherent low flammability

## APPLICATIONS

- Electrical and insulation connectors
- Structural components (such as connections and sealing rings)
- Wear applications involving impact load and abrasive wear
- Standard matrix of formed metal parts (T4503)
- Bearing cages



CHEMICAL RESISTANCE



ELECTRICAL INSULATION



WEAR RESISTANCE



SLIDING PROPERTIES



IMPACT RESISTANCE

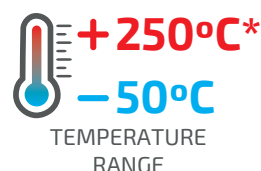

\*continuously (20.000H)

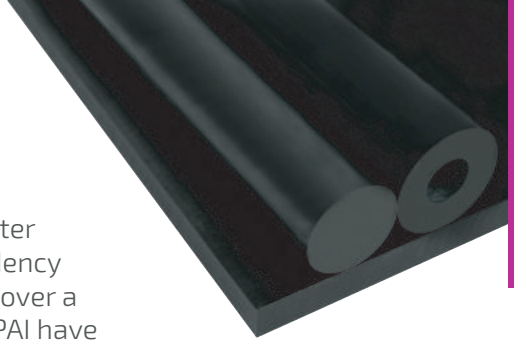

**Amorphous plastic**, with addition of PTFE and graphite, which provides greater wear resistance and lower coefficient of own friction, as well as a lower tendency for sliding. DURATRON® T4301 PAI also offers excellent dimensional stability over a wide range of temperatures. DURATRON® T4501 PAI and DURATRON® T4301 PAI have similar characteristics, being complementary in terms of availability and manufacturing format.



## MAIN CHARACTERISTICS

- High maximum service temperature in the air (250° C in continuous service)
- Excellent retention of mechanical resistance, stiffness and creep resistance over a wide range of temperatures
- Excellent dimensional stability up to 250°C
- Excellent wear and friction behaviour (particularly Duratron T4503)
- Very good resistance to UV rays
- Exceptional resistance to high energy radiation (gamma rays and X-rays)
- Inherent low flammability

## APPLICATIONS

- Non-lubricated bearings
- Seals
- Bearing cages
- Reciprocating compressor parts



CHEMICAL RESISTANCE



ELECTRICAL INSULATION



WEAR RESISTANCE



SLIDING PROPERTIES



IMPACT AO RESISTANCE

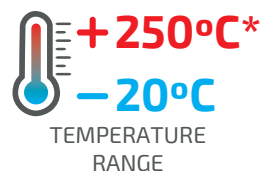

\*continuously (20.000H)

All figures given are indicative only, Polyanema Lda. is not liable for the use of the materials without consulting with our technical department.

# DURATRON® CU60 PBI

**Semi-crystalline plastic**, DURATRON® CU60 PBI offers the highest temperature resistance and the best retention of mechanical properties above 200°C of all thermoplastics. DURATRON® CU60 PBI is very "clean" in terms of ionic impurity. These characteristics make this material extremely useful for high-tech industries such as the semiconductor and aerospace industries. It is typically used on critical components to lower maintenance costs and obtain valuable production time.



## MAIN CHARACTERISTICS

- Extremely high maximum service temperature allowed in the air (310°C in continuous service and 500°C for short periods)
- Excellent retention of mechanical resistance, stiffness and creep resistance over a wide range of temperatures
- Excellent wear resistance and frictional behaviour
- Extremely low coefficient of linear thermal expansion
- Excellent resistance against high energy radiation (gamma rays and X-rays)
- Inherent low flammability
- High purity in terms of ionic contamination
- Good electrical insulation and dielectric properties
- Good resistance to UV rays

## APPLICATIONS

- Pump components
- (High-tech) valve seats
- Bearings
- Rollers
- High temperature insulators
- Electrical connectors
- Fixing rings



CHEMICAL RESISTANCE



ELECTRICAL INSULATION



WEAR RESISTANCE



SLIDING PROPERTIES



IMPACT RESISTANCE

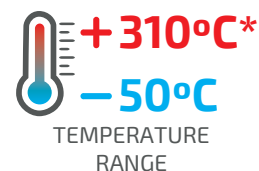

\*continuously (20.000H)



# DURATRON® PEI 1000

**Amorphous plastic**, DURATRON® U1000 PEI is a translucent thermoplastic material (non-optical quality), which offers high robustness and heat resistance. It has a good performance in continuous temperatures of 170°C, which makes it ideal for applications of high resistance, high temperatures and for applications that require dielectric properties consistent in a wide range of frequency and temperature.



## MAIN CHARACTERISTICS

- Good maximum service air temperature (170°C in continuous service)
- Very good hydrolysis resistance (suitable for repeated steam sterilization and capable of withstanding repeated cycles of autoclaving)
- High resistance and stiffness over a wide range of temperatures
- Inherent low flammability and low levels of smoke emission during combustion
- Good dimensional stability
- Physiologically inert (composition compatible with food contact)
- Very good resistance against high energy radiation (gamma rays and X-rays)
- Very good electrical insulation and dielectric properties

## APPLICATIONS

- Electrical/electronic insulation (including many components of semiconductor processes)
- Structural components requiring high resistance and stiffness at high temperatures
- Structural probes
- Collectors
- Clamps



CHEMICAL RESISTANCE



ELECTRICAL INSULATION



WEAR RESISTANCE



SLIDING PROPERTIES



IMPACT AO RESISTANCE

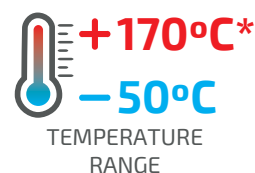

\*continuously (20.000H)

PLATES

THICKNESS (mm)	DURATRON® CU60 PBI	
	KG/PIECE <sup>(1)</sup>	STOCK
Standard size 305 x 305 mm <sup>(2)</sup>		
12.70	1.57	●
15.88	1.96	○
19.05	2.36	○
22.23	2.69	○
25.40	3.14	●
31.75	3.93	○
38.10	4.59	○
Standard size 305 x 610 mm <sup>(2)</sup>		
12.70	3.14	○
15.88	3.82	○

Other measures available on request, subject to special conditions  
 (1): theoretical weights  
 (2): all dimensions shown correspond to minimum values

PLATES

THICKNESS (mm) <sup>(1)(2)</sup>	DURATRON® T4203 PAI		DURATRON® T4301 PAI		DURATRON® T4501 PAI	
	KG/PIECE <sup>(3)</sup>	STOCK	KG/PIECE <sup>(3)</sup>	STOCK	KG/PIECE <sup>(3)</sup>	STOCK
Standard size 305 x 1220 mm <sup>(1)</sup>						
6.35	3.89	●	3.43	●	-	-
9.53	5.66	●	5.14	●	1.28	○
12.70	7.43	●	6.85	●	1.71	○
15.88	8.33	○	8.57	●	2.14	○
19.05	9.99	○	10.30	○	2.57	○
25.40	14.50	○	13.70	○	3.43	○
31.75	-	-	-	-	4.93	○
38.10	-	-	-	-	5.15	○
44.45	-	-	-	-	6.00	○
50.80	-	-	-	-	7.82	○

Other measures on request, subject to special conditions  
 (1): all dimensions shown correspond to minimum values  
 (2): for intermediate thicknesses not listed, please consult us  
 (3): theoretical weights, based on nominal dimensions and mean density

ROUND RODS

DIAMETER (mm) <sup>(1)(2)</sup>	DURATRON® T4503 PAI		DURATRON® T4501 PAI	
	KG/PIECE <sup>(3)</sup>	STOCK	KG/PIECE <sup>(3)</sup>	STOCK
Standard length 153 mm <sup>(1)</sup>				
57.15	0.55	○	-	○
60.33	-	○	0.64	○
63.50	0.68	○	-	○
66.68	-	○	0.78	○
69.85	0.82	○	-	○
73.03	-	○	0.93	○
76.20	0.97	○	-	○
79.38	-	○	1.10	○
85.73	-	○	1.28	○
88.90	1.33	○	-	○
101.60	1.60	○	2.04	○
127.00	2.94	○	2.81	○
152.40	3.91	○	4.05	○
177.80	5.34	○	0.25	○
203.20	7.52	○	7.69	○
228.60	8.79	○	9.11	○
254.00	11.76	○	11.25	○

Other measures, including Duratron® T4503 and T4501, on request, subject to special conditions  
 (1): all dimensions shown correspond to minimum values  
 (2): for intermediate diameters not listed, please consult us  
 (3): theoretical weights, based on nominal dimensions and mean density

ROUND RODS

DIAMETER (mm) <sup>(1)(2)</sup>	DURATRON® T4203 PAI		DURATRON® T4301 PAI	
	KG/PIECE <sup>(3)</sup>	STOCK	KG/PIECE <sup>(3)</sup>	STOCK
Standard length 2440 mm <sup>(1)</sup>				
2.38	0.02	○	-	-
3.18	0.03	○	-	-
6.35	0.11	●	0.11	●
9.53	0.31	●	0.25	●
12.70	0.44	●	0.45	●
15.88	0.79	●	0.70	●
19.05	0.98	●	1.14	●
25.40	1.74	●	1.79	●
31.75	2.95	●	2.80	●
34.93	3.30	○	3.39	○
38.10	3.92	●	4.03	○
50.80	7.36	●	7.17	●

Other measures, including Duratron® T4503 and T4501, on request, subject to special conditions  
 (1): all dimensions shown correspond to minimum values  
 (2): for intermediate diameters not listed, please consult us  
 (3): theoretical weights, based on nominal dimensions and mean density



SPECIFIC EQUIPMENT TO ENSURE  
WATER JET CUTTING INTEGRITY!

● Standard: generally available from stock  
 ● Semi-standard: generally not available from stock  
 ○ Non-standard: generally not available from stock, manufactured to order and subject to special conditions

## ROUND RODS

DIAMETER (mm) <sup>(1)(2)</sup>	DURATRON® CU60 PBI	
	KG/PIECE <sup>(3)</sup>	STOCK
Standard length 305 mm <sup>(1)</sup>		
9.53	0.03	○
12.70	0.05	○
15.88	0.08	●
19.05	0.11	●
22.23	0.15	○
25.40	0.20	●
31.75	0.31	●
38.10	0.45	○
Standard length 153 mm <sup>(1)</sup>		
50.80	0.40	○
66.68	0.84	○
88.90	1.26	○
98.43	1.80	○

- (1): all dimensions shown correspond to minimum values  
 (2): for intermediate diameters not listed, consult us  
 (3): theoretical weights

## TUBES

DIAM. (mm) <sup>(1)(2)</sup> Ø O.D. x Ø I.D.	DURATRON® T4501 PAI		DURATRON® T4503 PAI	
	KG/PIECE <sup>(3)</sup>	STOCK	KG/PIECE <sup>(3)</sup>	STOCK
Standard length 153 mm <sup>(1)</sup>				
76.20 x 44.45	0.84	○	0.81	○
127.00 x 76.20	2.79	○	2.26	○
139.70 x 111.13	2.88	○	1.30	○
177.80 x 50.80	11.03	○	11.03	○
177.80 x 101.60	4.87	○	4.78	○
177.80 x 127.00	2.61	○	3.65	○
184.15 x 158.75	1.62	○	1.57	○
203.20 x 50.80	14.70	○	14.70	○
203.20 x 127.00	5.74	○	5.64	○
254.00 x 76.20	22.30	○	22.30	○
279.40 x 152.40	10.95	○	10.75	○
304.80 x 88.90	32.28	○	16.70	○
304.80 x 203.20	8.89	○	10.05	○
381.00 x 228.60	18.40	○	18.05	○
381.00 x 279.40	14.82	○	13.00	○

- Other measures, including Duratron CU60 PBI, on request, subject to special conditions  
 (1): all dimensions shown correspond to minimum values  
 (2): for intermediate diameters not listed, please consult us  
 (3): theoretical weights, based on nominal dimensions and mean density

## PLATES

THICKNESS (mm)	TOLERANCES (mm)	PEI 1000	
		KG/PIECE <sup>(1)</sup>	STOCK
Standard size 610 x 1220 mm <sup>(2)</sup>			
6.35	0.0 +0.65	6.92	○
9.53		10.06	○
12.70		13.21	●
19.05		19.50	○
25.40		25.79	○
38.10		38.37	○
44.45		42.30	○
50.80		50.95	○
Other standard sizes 305 x 610 mm <sup>(2)</sup>			

- Other measures available on request, subject to special conditions  
 (1): theoretical weights, based on nominal dimensions and mean density  
 (2): **TOLERANCES IN WIDTH AND LENGTH:**  
 605 (-0/+15) x 610 (-0/+15) mm  
 610 (-0/+15) x 1220 (+5/+25) mm

## ROUND RODS

DIAMETER (mm) <sup>(1)</sup>	TOLERANCES (mm)	PEI 1000		
		KG/PIECE <sup>(1)</sup>	STOCK	
Standard length 2440 mm <sup>(3)</sup>				
6.35	0.0 +0.10	0.10	○	
9.53		0.23	○	
12.70		0.40	●	
15.88		0.63	○	
19.05		0.91	○	
25.40		1.61	○	
31.75		2.52	○	
38.10		0.0 +0.15	3.62	●
50.80		6.42	●	
63.50	0.0 +0.40	10.10	○	
Other standard lengths 1220 mm <sup>(3)</sup>				
76.20	0.0 +6.50	8.52	○	
101.60		14.57	○	
127.00		22.23	○	
152.40		31.50	○	

- Other measures available on request, subject to special conditions  
 (1): for intermediate diameters not listed, please consult us  
 (2): theoretical weights, based on nominal dimensions and mean density  
 (3): all lengths correspond to minimum values

**PRECISION AND QUALITY  
MACHINING SERVICES!**



- Standard: generally available from stock
- Semi-standard: generally not available from stock
- Non-standard: generally not available from stock, manufactured to order and subject to special conditions



# FLUOROSINT® 207

**Semi-crystalline plastic**, FLUOROSINT® 207 lasts much longer than PTFE **without loads** in wear applications and has a very low coefficient of friction. It is the material recommended for low pressure seats and seals where virgin PTFE fails and food contact compliance may be required. In addition to that, the composition of the raw materials used for the manufacturing of FLUOROSINT® 207 is also FDA compliant for plastic materials and parts intended for food contact.



## MAIN CHARACTERISTICS

- High maximum service air temperature (260°C in continuous service)
- Good mechanical performance
- Excellent resistance to chemicals and hydrolysis resistance
- Good dimensional stability
- Low deformation under load
- Low coefficient of friction and good wear resistance
- Excellent resistance to UV rays and adverse weather conditions
- Physiologically inert
- Inherent low flammability
- Good properties

## APPLICATIONS

- Bearings
- Bushings
- High performance seals where higher loads and minimum wear are required
- Food industry
- Pharmaceutical industry
- Chemical processing
- Valve seats

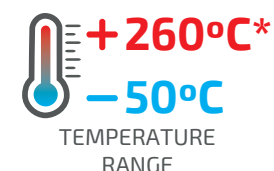
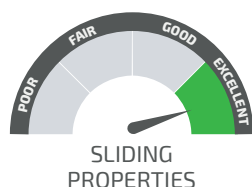
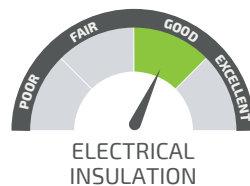

\*continuously (20.000H)

# FLUOROSINT® 500

**Semi-crystalline plastic**, reinforced with synthetic mica, this material exhibits, in addition to its excellent chemical resistance and hydrolysis, excellent mechanical and tribological properties. FLUOROSINT® 500 has a resistance to deformation under load nine times greater than PTFE. Its coefficient of linear thermal expansion approximates the expansion rate of aluminium and is 1/4 of the virgin PTFE. PTFE reinforced with FLUOROSINT® 500 offers an ideal combination of stability and wear resistance for sealing applications where excellent dimensional stability is required.



## MAIN CHARACTERISTICS

- ◆ High maximum service air temperature (260°C in continuous service)
- ◆ Moderate mechanical resistance and stiffness
- ◆ Excellent resistance to chemicals and hydrolysis resistance
- ◆ Good dimensional stability (approximate to aluminium)
- ◆ Coefficient of linear expansion like aluminium
- ◆ Low deformation under load
- ◆ Low coefficient of friction and good wear resistance
- ◆ Excellent resistance to UV rays and adverse weather conditions
- ◆ High resistance to fuels and lubricants
- ◆ Inherent low flammability

## APPLICATIONS

- ◆ Bearings
- ◆ Bushings
- ◆ High performance seals where higher loads and minimum wear are required
- ◆ High pressure seals and wear parts where accuracy is critical
- ◆ Valve seats

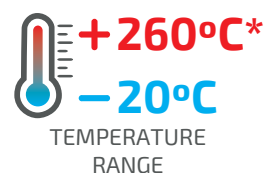
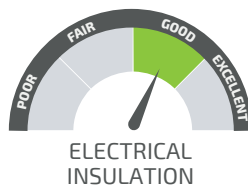

\*continuously (20.000H)

ROUND RODS

DIAMETERS (mm) <sup>(1)</sup>	TOLERANCES (mm)		FLUOROSINT® 207		FLUOROSINT® 500	
			KG/PIECE <sup>(2)</sup>	STOCK	KG/PIECE <sup>(2)</sup>	STOCK
Standard length 1220 mm <sup>(3)</sup>						
12.70	-0.03	+0.03	0.37	○	0.36	○
19.05			0.82	●	0.81	●
25.40	0.0	+0.30	1.44	○	1.43	●
31.75			2.22	●	2.24	○
Other standard lengths 305 mm <sup>(3)</sup>						
12.70	0.0	+3.00	0.09	○	0.09	○
19.05			0.20	○	0.20	○
25.40			0.36	○	0.40	○
31.75			0.56	○	0.58	○
38.10			0.80	○	0.81	○
44.45			1.09	○	1.36	○
50.80			1.42	○	1.75	●
53.98			1.61	○	1.62	○
57.15			1.80	○	1.82	○
63.50			2.22	○	2.24	●
69.85			2.69	○	2.71	○
76.20			3.20	○	3.23	○
82.55			3.75	○	3.79	○
88.90			4.62	○	4.39	○
95.25			5.00	○	5.04	○
101.60			5.69	○	5.74	○
107.95			6.42	○	6.48	○
114.30			7.20	○	7.26	○
120.65			8.02	○	9.22	○
127.00			8.89	○	10.70	○
139.70	10.75	○	12.83	○		
152.40	0.0	+6.00	12.80	○	14.41	○
177.80			20.22	○	17.55	○
203.20			26.20	○	25.11	○
222.25			27.20	○	27.45	○

(1): for intermediate diameters not listed, please consult us  
 (2): theoretical weights, based on nominal dimensions and mean density  
 (3): all lengths correspond to minimum values

PLATES

THICKNESS (mm)	TOLERANCES (mm)		FLUOROSINT® 207		FLUOROSINT® 500	
			KG/PIECE <sup>(1)</sup>	STOCK	KG/PIECE <sup>(1)</sup>	STOCK
Standard size 305 x 305 mm <sup>(2)</sup>						
6.35	0.0	+1.0	1.36	○	1.37	●
7.94	0.0	+1.5	1.70	○	2.04	○
9.53			2.04	●	2.06	●
12.70	0.0	+2.0	2.72	○	2.74	○
19.05	0.0	+3.0	4.08	○	4.11	○
25.40	0.0	+4.0	5.43	○	5.48	○
31.75	0.0	+5.0	6.79	○	6.85	○
38.10	0.0	+6.0	8.15	○	8.22	○
44.45	0.0	+7.0	9.51	○	10.17	○
50.80	0.0	+8.0	12.40	○	10.95	○
63.50	0.0	+10.0	15.46	○	15.59	○
76.20	0.0	+12.0	17.33	○	16.45	○

(1): theoretical weights, based on nominal dimensions and mean density  
 (2): tolerances in width and length -0 / + 6 mm

- Standard: generally available from stock
- ◐ Semi-standard: generally not available from stock
- Non-standard: generally not available from stock, manufactured to order and subject to special conditions



**TUBES**

DIAM. (mm) <sup>(1)</sup> Ø O.D. x Ø I.D.	KG/ PIECE <sup>(2)</sup>	STANDARD LENGTH (mm)	FLUROSINT® 207	FLUROSINT® 500
69.85 x 44.45	1.61	305	○	●
69.85 x 50.80	1.27	305	○	●
76.20 x 57.15	1.41	305	○	●
88.90 x 50.80	2.95	305	○	●
88.90 x 63.50	2.77	305	○	●
101.60 x 25.40	5.36	305	○	●
120.65 x 95.25	3.03	305	○	●
266.70 x 215.90	13.55	305	○	●
304.80 x 254.00	15.70	305	○	●

(1): for intermediate diameters not listed, please consult us  
 (2): theoretical weights, based on nominal dimensions and mean density

**TOLERANCES IN DIAMETER (mm)**

Ø Ext. 31.75 - 120.65: ØExt -0.0 / +3 | ØInt -0.0 / -1.5  
 Ø Ext. 127.00 - 304.80: ØExt -0.0 / +6 | ØInt -0.0 / -3

**TOLERANCES LENGTH (mm)**

76: -0.0 / +6  
 150: -0.0 / +13  
 305: -0.0 / +25

**THINKING OF YOU, WE CUT THE  
 MATERIALS TO YOUR MEASURE**



● Standard: generally available from stock  
 ● Semi-standard: generally not available from stock  
 ○ Non-standard: generally not available from stock, manufactured to order and subject to special conditions

# KETRON® PEEK 1000

**Semi-crystalline plastic,** KETRON® PEEK 1000 is produced from virgin polyetheretherketone resin and offers the highest toughness and impact resistance of all types of Ketron® PEEK. Both natural and black KETRON® PEEK 1000 can be sterilized by all conventional sterilization methods (steam, dry heat, ethylene oxide and gamma irradiation). The composition of the raw materials used for the manufacturing of KETRON® PEEK 1000 is also FDA compliant for plastic materials and parts intended for food contact.

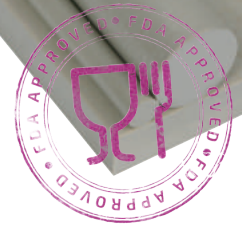

## MAIN CHARACTERISTICS

- High maximum service air temperature (250°C in continuous service and 310°C for short periods)
- High mechanical resistance, stiffness and creep resistance, also at high temperatures
- Excellent resistance to chemicals and hydrolysis resistance
- Excellent wear resistance and frictional behaviour
- Very good dimensional stability
- Excellent resistance against high energy radiation (gamma rays and X-rays)
- Good electrical and dielectric insulation properties
- Good PTFE replacement when mechanical load capacity is bigger or when higher wear resistance is required

## APPLICATIONS

- Metallic components
- Pump components
- Valve seats
- Bearings
- Rollers
- Gears
- High temperature insulators
- Components exposed to boiling water or steam

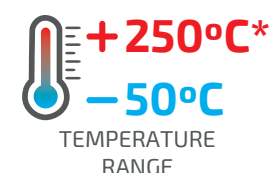
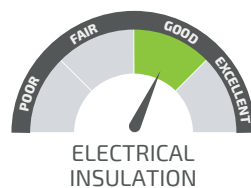
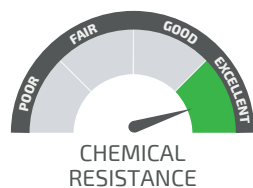

\*continuously (20.000H)

# KETRON® PEEK HPV

**Semi-crystalline plastic**, with addition of carbon fibres, PTFE and graphite. Its excellent tribological properties (low friction, long wear and high-pressure speed capability) make this quality especially suitable for wear and friction applications.

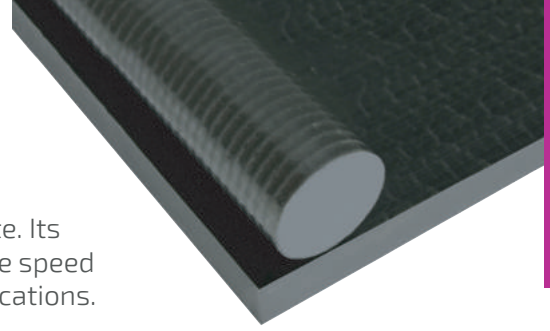

## MAIN CHARACTERISTICS

- High maximum service air temperature (250°C in continuous service and 310°C for short periods)
- High mechanical resistance, stiffness and creep resistance, also at high temperatures
- Excellent resistance to chemicals and hydrolysis resistance
- High wear and frictional behaviour (better than Ketron® PEEK 1000)
- Very good dimensional stability
- Excellent resistance against high energy radiation (gamma rays and X-rays)
- Good electrical and dielectric insulation properties

## APPLICATIONS

- Metallic components
- Pump components
- Valve seats
- Bearings
- Rollers
- Gears
- High temperature insulators
- Components exposed to boiling water or steam
- Wear and friction applications

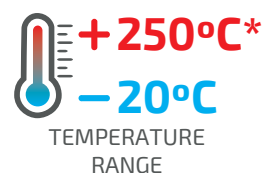
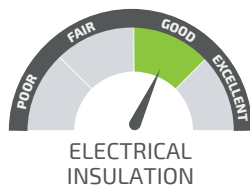

\*continuously (20.000H)



# KETRON® PEEK GF30

**Semi-crystalline plastic**, reinforced with 30% glass fibre offers greater stiffness and creep resistance than KETRON® PEEK 1000 and has a much better dimensional stability. KETRON® PEEK GF30 is very suitable for structural applications that withstand high static loads for long periods of time at high temperatures. The application of KETRON® PEEK GF30 to sliding parts should be carefully examined, since glass fibres tend to wear out the contact surface.

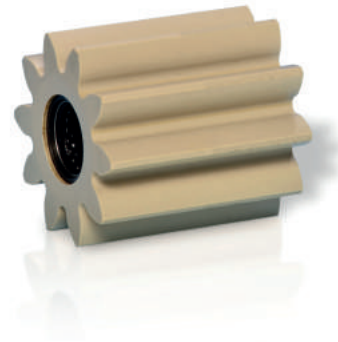

## MAIN CHARACTERISTICS

- High maximum service air temperature (250°C in continuous service and 310°C for short periods)
- High mechanical resistance, stiffness and creep resistance, also at high temperatures
- Excellent resistance to chemicals and hydrolysis
- Excellent wear resistance and frictional behaviour
- Very good dimensional stability
- Excellent resistance against high energy radiation (gamma rays and X-rays)
- Good PTFE replacement when mechanical load capacity is bigger or when higher wear resistance is required

## APPLICATIONS

- Metallic components
- Pump components
- Valve seats
- Bearings
- Rollers
- Gears
- High temperature insulators
- Components exposed to boiling water or steam
- Bearing cages



CHEMICAL RESISTANCE



ELECTRICAL INSULATION



WEAR RESISTANCE



SLIDING PROPERTIES



IMPACT RESISTANCE

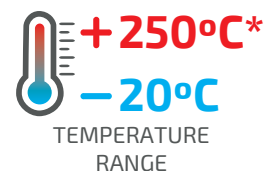

\*continuously (20.000H)

# KETRON® PEEK CA30

**Semi-crystalline plastic**, reinforced with 30% carbon fibres, combines even greater rigidity, mechanical resistance and resistance to deformation than KETRON® PEEK GF30 with an ideal wear resistance. In addition, compared to unreinforced PEEK, carbon fibres considerably reduce thermal expansion and provide 3.5 times more thermal conductivity - dissipating heat from the bearing surface faster, improving bearing service life and pressure speed capacity.

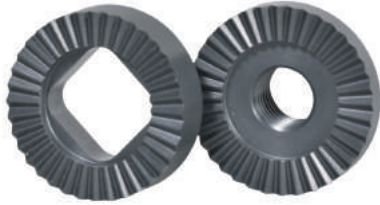

## MAIN CHARACTERISTICS

- High maximum service air temperature (250°C in continuous service and 310°C for short periods)
- High mechanical resistance, stiffness and creep resistance, also at high temperatures
- Excellent resistance to chemicals (acids and alkalis) and hydrolysis resistance
- Excellent wear resistance and frictional behaviour
- Consistent and improved dimensional stability
- Excellent resistance against high energy radiation (gamma rays and X-rays)
- Good PTFE replacement when mechanical load capacity is bigger or when higher wear resistance is required

## APPLICATIONS

- Metallic components
- Pump components
- Valve seats
- Bearings
- Rollers
- Gears
- High temperature insulators
- Components exposed to boiling water or steam
- Wear rings

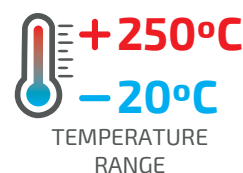
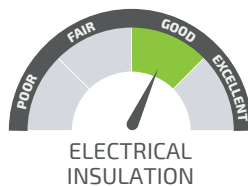

\*continuously (20.000H)

ROUND RODS

DIAMETER (mm)	TOLERANCES (mm)		KETRON® PEEK 1000			KETRON® PEEK HPV		KETRON® PEEK GF30		KETRON® PEEK CA30	
			KG/PIECE <sup>(1)</sup>	NATURAL	BLACK	KG/PIECE <sup>(1)</sup>	STOCK	KG/PIECE <sup>(1)</sup>	STOCK	KG/PIECE <sup>(1)</sup>	STOCK
Standard length 3000 mm <sup>(2)</sup>											
6	+0.1	+0.4	0.12	●	○	0.14	●	0.14	○	0.14	○
8	+0.1	+0.5	0.22	●	○	0.24	●	0.25	○	0.24	○
10			0.33	●	●	0.37	●	0.38	●	0.36	●
12	+0.2	+0.9	0.49	●	●	0.55	●	0.58	○	0.54	○
15			0.76	●	○	0.85	○	0.88	○	0.83	○
16			0.86	●	●	0.96	●	1.00	○	0.94	○
18			1.07	●	○	1.20	○	1.25	○	1.17	○
20	+0.2	+1.2	1.32	●	●	1.47	●	1.53	●	1.44	●
22			1.61	●	○	1.80	○	1.88	○	1.76	○
25			2.06	●	●	2.30	●	2.40	○	2.25	○
28			2.57	●	○	2.87	○	2.99	○	2.81	○
30	+0.3	+2.5	2.94	●	●	3.27	●	3.42	●	3.21	●
32			3.33	●	○	3.72	○	3.87	○	3.63	○
35			4.02	●	●	4.47	●	4.68	○	4.38	○
40	+0.2	+1.6	5.22	●	●	5.82	●	6.06	●	5.70	●
45	+0.3	+2.0	6.66	●	○	7.41	○	7.71	○	7.26	○
50			8.16	●	●	9.09	●	9.48	●	8.91	●
56			10.20	●	○	11.34	○	11.82	○	11.10	○
60	+0.3	+2.5	11.76	●	○	13.11	●	13.65	●	12.84	○
65			13.77	●	○	15.30	○	15.96	○	15.00	○
70			15.90	●	○	17.70	○	18.42	○	17.34	○
80	+0.4	+3.0	20.82	●	○	23.19	●	24.15	●	22.71	●
90	+0.5	+3.4	26.40	●	○	29.37	○	30.60	○	-	-
100	+0.6	+3.8	32.55	●	○	36.30	●	37.80	●	-	-
110	+0.7	+4.2	39.00	●	○	-	-	-	-	-	-
120	+0.8	+4.6	46.35	●	○	-	-	-	-	-	-
130	+0.9	+5.4	54.60	●	○	-	-	-	-	-	-
140			63.15	●	○	-	-	-	-	-	-
150	+1.0	+5.8	72.45	●	○	-	-	-	-	-	-
160			82.35	●	○	-	-	-	-	-	-
180			103.80	●	○	-	-	-	-	-	-
200			127.80	●	○	-	-	-	-	-	-
Other standard lengths 1000 mm <sup>(3)</sup>											

Other measures available on request, subject to special conditions  
 (1): average production weights (2): tolerances in length -0 / + 3% (3): non-standard sizes for diameters above 60mm

TUBES

DIAM. (mm) <sup>(1)</sup> Ø O.D. x Ø I.D.	TOLERANCES (mm)		KETRON® PEEK 1000			KETRON® PEEK HPV		KETRON® PEEK GF30		KETRON® PEEK CA30	
			KG/PIECE <sup>(2)</sup>	NATURAL	BLACK	KG/PIECE <sup>(2)</sup>	STOCK	KG/PIECE <sup>(2)</sup>	STOCK	KG/PIECE <sup>(2)</sup>	STOCK
Standard length 3000 mm <sup>(3)</sup>											
50 x 30	+0.5	+2.2 -0.5 -2.2	5.67	●	○	6.24	○	6.51	○	6.12	○
60 x 40	+0.6	+2.8 -0.6 -2.8	7.29	●	○	8.07	○	8.40	○	7.89	○
70 x 50	+0.6	+3.4 -0.6 -3.4	9.00	●	○	9.93	○	10.32	○	9.72	○
80 x 60			10.50	●	○	11.58	○	12.06	○	11.34	○
100 x 80	+1.0	+4.0 -1.4 -5.4	14.49	●	○	15.96	○	16.65	○	15.63	○
115 x 90	+1.3	+5.0 -1.8 -7.0	20.70	●	○	22.83	○	23.79	○	22.35	○
140 x 100			35.40	●	○	39.15	○	40.80	○	38.25	○
160 x 120	+1.6	+6.0 -2.0 -8.0	42.45	●	○	46.80	○	48.75	○	45.90	○
180 x 140			48.60	●	○	53.55	○	55.80	○	52.50	○
Other standard lengths 1000 mm <sup>(3)</sup>											

Other measures available on request, subject to special conditions  
 (1): for diameters not listed, please consult us (2): average production weights (3): tolerances in length -0 / + 3%

- Standard: generally available from stock
- ◐ Semi-standard: generally not available from stock
- Non-standard: generally not available from stock, manufactured to order and subject to special conditions

PLATES

THICKNESS (mm)	TOLERANCES (mm)		KETRON® PEEK 1000			KETRON® PEEK HPV		KETRON® PEEK GF30		KETRON® PEEK CA30	
			KG/PIECE <sup>(1)</sup>	NATURAL	BLACK	KG/PIECE <sup>(1)</sup>	STOCK	KG/PIECE <sup>(1)</sup>	STOCK	KG/PIECE <sup>(1)</sup>	STOCK
Standard size 610 x 1000 mm <sup>(2)</sup>						Standard size 625 x 3000 mm <sup>(2)</sup>					
10	+0.2	+0.9	8.90	●	○	-	-	-	-	-	-
12	+0.3	+1.5	10.95	○	○	36.90	○	38.40	○	36.15	○
16			14.25	●	○	48.00	●	50.10	○	47.10	○
20			17.60	○	○	59.25	●	61.65	●	58.05	○
25			21.75	●	○	73.20	○	76.20	○	71.70	○
30	+0.5	+2.5	26.55	●	○	89.40	●	93.15	○	87.45	○
35			30.70	●	○	103.35	○	107.70	●	101.25	●
40			34.85	●	○	117.30	●	122.25	○	114.90	○
45			39.00	○	○	131.40	○	136.80	○	128.55	○
50	+0.5	+3.5	43.15	●	○	145.35	○	151.35	○	142.35	○
60			52.00	●	○	175.05	○	182.40	○	171.45	○
Standard size 1000 x 1000 mm <sup>(2)</sup>						Standard size 525 x 3000 mm <sup>(2)(3)</sup>					
5	+0.2	+0.7	7.51	●	○	13.23	○	13.77	○	12.96	○
6			8.85	●	○	15.60	○	16.23	○	15.27	○
8	+0.2	+0.9	11.70	●	○	20.64	●	21.51	○	20.22	○
10			14.40	●	○	25.38	●	26.43	○	24.84	○
12	+0.3	+1.5	17.70	●	○	-	-	-	-	-	-
16			23.10	●	○	-	-	-	-	-	-
20			28.45	●	○	-	-	-	-	-	-
25			35.20	●	○	-	-	-	-	-	-
Other standard sizes 615 x 1000 mm						Other standard sizes 525 x 1000 mm / 625 x 1000 <sup>(2)(3)</sup>					

Other measures available on request, subject to special conditions  
 (1): average production weights  
 (2): tolerances in length -0 / + 3%; in width + 5 / + 25 mm  
 (3): non-standard sizes for thicknesses over 25mm

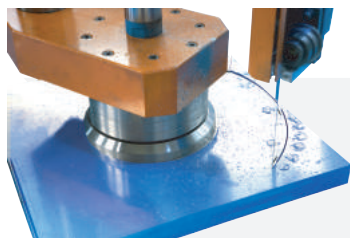

DIFFERENT TYPES OF HIGH PRECISION  
CUTTING AT **YOUR DISPOSAL!**

● Standard: generally available from stock  
 ● Semi-standard: generally not available from stock  
 ○ Non-standard: generally not available from stock, manufactured to order and subject to special conditions



# PSU 1000

**Amorphous plastic,** PSU 1000 is a slightly yellow and translucent thermoplastic material (non-optical quality), which offers a combination of excellent mechanical, thermal and electrical properties. It often replaces polycarbonate whenever higher temperature resistance, better chemical resistance or autoclavability are required.



## MAIN CHARACTERISTICS

- High maximum service air temperature (150°C in continuous service)
- Good hydrolysis resistance (suitable for repeated steam sterilization)
- High resistance and stiffness over a wide range of temperatures
- Good dimensional stability
- Physiologically inert (composition compatible with food contact)
- Very good resistance against high energy radiation (gamma rays and X-rays)
- Very good electrical insulation and dielectric properties

## APPLICATIONS

- Food processing equipment (milk machines, pumps, valves, filter plates, heat exchangers, among others)
- Analytical instrumentation and all types of components that undergo repeated cleaning and sterilization operations
- Collectors
- Distribution valves
- Medical Equipment Components
- Steam cleaning equipment inserts



CHEMICAL RESISTANCE



ELECTRICAL INSULATION



WEAR RESISTANCE



SLIDING PROPERTIES



IMPACT RESISTANCE

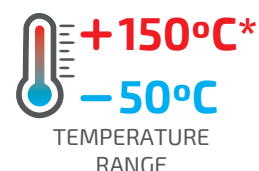

\*continuously (20.000H)

### ROUND RODS

DIAMETER (mm)	TOLERANCES (mm)		KG/PIECE <sup>(1)</sup>	STOCK
Standard length 3000 mm <sup>(2)</sup>				
16	+0.2	+0.9	0.89	○
20			1.27	●
25	+0.2	+1.2	2.00	○
30			2.84	○
36	+0.2	+1.6	4.08	○
40			5.01	●
50			7.86	○
Other standard lengths 1000 mm <sup>(2)(3)</sup>				

Other measures available on request, subject to special conditions  
 (1): average production weights  
 (2): tolerances in length -0 / + 3%  
 (3): non-standard dimensions for diameters greater than 60mm

### PLATES

THICKNESS (mm)	TOLERANCES (mm)		KG/PIECE <sup>(1)</sup>	STOCK		
Standard size 625 x 3000 mm <sup>(2)</sup>						
10	+0.2	+0.9	25.71	○		
12			31.65	○		
15			40.50	○		
16			+0.3	+1.5	41.25	○
20					50.85	○
25	+0.5	+2.5	62.85	○		
30			76.65	○		
40			100.65	○		
50			124.65	○		
60			+0.5	+3.5	150.15	○
70					174.15	○
80			+0.5	+5.0	200.55	○
Other standard sizes 625 x 1000 mm <sup>(2)(3)</sup>						

Other measures available on request, subject to special conditions  
 (1): average production weights  
 (2): tolerances in width + 5 / + 25mm, length -0 / + 3%  
 (3): non-standard sizes for thicknesses over 25mm

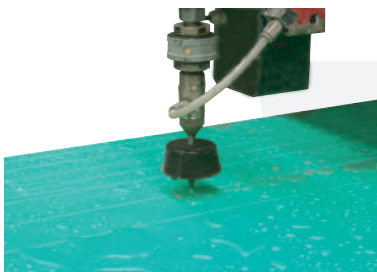

**REDUCE YOUR COSTS WITH OUR WATER JET CUTTING SERVICE**

● Standard: generally available from stock  
 ● Semi-standard: generally not available from stock  
 ○ Non-standard: generally not available from stock, manufactured to order and subject to special conditions

# PVDF 1000

**Semi-crystalline plastic,** PVDF 1000 is an unreinforced crystalline fluoropolymer, which combines good mechanical, thermal and electrical properties with excellent chemical resistance. It also shows good resistance to high energy radiations. In addition, the composition of the raw material used for the manufacturing of PVDF complies with EU/FDA regulations for food-compatible plastic materials. All these properties make this product a very versatile engineering material and with numerous applications in diverse types of industry.

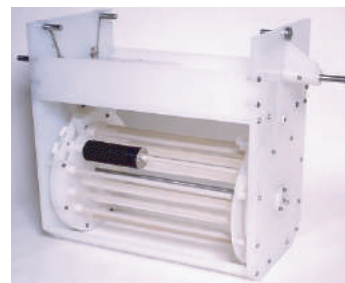

## MAIN CHARACTERISTICS

- High maximum service air temperature (150°C in continuous service)
- High mechanical resistance, creep and stiffness (higher than other fluoropolymers)
- High chemical resistance and hydrolysis resistance
- Good resistance to wear, sliding and contraction
- Very good dimensional stability
- Good dielectric properties and good electrical insulation
- Excellent resistance to UV rays and environment
- Intrinsic flame resistance, much higher than that of the remaining fluoropolymers.

## APPLICATIONS

- Electrical/electronic insulation (including many components of semiconductor processes)
- Structural components requiring high resistance and stiffness at high temperatures



CHEMICAL RESISTANCE



ELECTRICAL INSULATION



WEAR RESISTANCE



SLIDING PROPERTIES



IMPACT RESISTANCE

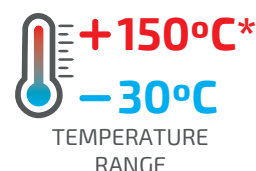

\*continuously (20.000H)

### ROUND RODS

DIAMETER (mm)	TOLERANCES (mm)		KG/METER	STOCK
Standard length 3000 mm				
10	+0.1	+0.7	0.15	●
12	+0.2	+0.8	0.22	○
15			0.34	○
20			0.60	○
25	+0.2	+1.0	0.93	●
30	+0.2	+1.1	1.34	○
35	+0.2	+1.2	1.82	●
40	+0.3	+1.3	2.37	○
45			2.99	○
50			3.74	○
56	+0.3	+1.6	4.58	○
60			5.35	●
70			7.25	○
80	+0.4	+2.0	9.35	●
90	+0.5	+2.2	11.90	○
95	+0.6	+2.5	13.77	○
100			14.80	○
110	+0.7	+3.0	17.86	○
125	+0.8	+3.5	22.94	○
Standard length 1000 mm				
140	+0.9	+3.8	28.92	○
150	+1.0	+4.2	33.08	○
165	+1.2	+5.0	39.87	○
180			47.57	○
200	+1.3	+5.5	59.58	○
225	+1.5	+6.2	77.25	○
250			91.55	○

Average production weights

### PLATES

THICKNESS (mm)	TOLERANCES (mm)		KG/METER	STOCK
Standard size 610 x 1000 mm				
10	+0.2	+1.1	13.07	○
12	+0.3	+1.5	15.13	●
16			19.81	○
20			24.51	○
22			26.97	○
25			30.39	○
30	+0.5	+2.5	36.95	○
35			43.10	○
40			48.57	○
45	-0.5	+3.5	54.76	○
50			60.41	○
60			72.71	○
80			96.38	○
Other standard sizes 1000 x 1000 mm				

Average production weights

WE SUPPLY **MODERN AND PRECISE**  
CNC EQUIPMENT!

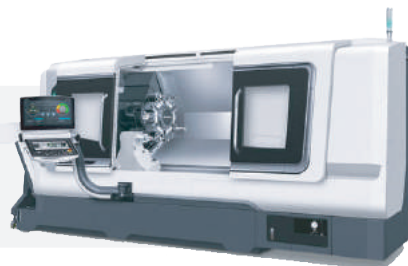

● Standard: generally available from stock  
○ Semi-standard: generally not available from stock  
○ Non-standard: generally not available from stock, manufactured to order and subject to special conditions



# SEMITRON® ESd 500 HR

**Semi-crystalline plastic**, reinforced with synthetic mica, SEMITRON® ESd 500HR offers an excellent combination of low friction properties, good dimensional stability and electrostatic dissipation. Where virgin PTFE causes electrical discharge problems, SEMITRON® ESd 500HR is an excellent alternative, controlling static charges while maintaining typical PTFE properties such as high chemical resistance and low coefficient of friction.

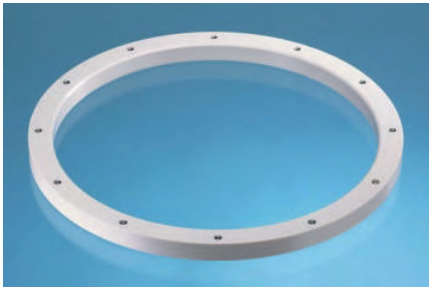

## MAIN CHARACTERISTICS

- Permanent static dissipative
- Dissipates static loads (5kV)
- Its composition does not contain any metal or graphite powder
- Depending on the base polymer, it can exhibit thermal performance between 90° and 260°C (in continuous service)
- Thermally insulating
- Very low coefficient of friction
- Wide chemical resistance

## APPLICATIONS

- Antistatic inserts
- Manufacturing and handling of sensitive electronic components such as integrated circuits, hard disks and circuit boards
- Material Handling Applications
- High-speed electronic printing components
- Reproduction Equipment

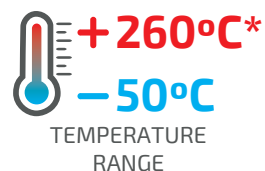
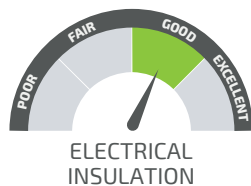

\*continuously (20.000H)

# SEMITRON® ESd 520 HR

**Amorphous plastic**, SEMITRON® ESd 520HR has a combination of electrostatic dissipation (ESd), high robustness and heat resistance. It is ideal for test equipment and others in the semiconductor industry. The main feature of Semitron 520HR is its unique ability to resist to dielectric breakdown at high voltages (> 100V). SEMITRON® ESd 520HR keeps its electrical performance over the entire 100 to 1000 V voltage range, providing the mechanical performance needed to stand out in demanding applications.

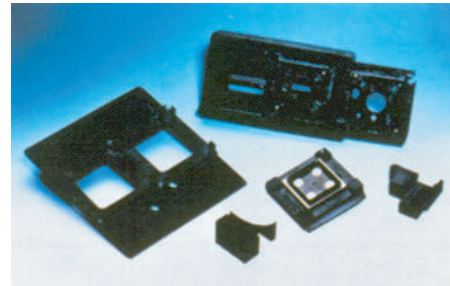

## MAIN CHARACTERISTICS

- Permanent static dissipative
- Dissipates static loads (5kV)
- Its composition does not contain any metal or graphite powder
- Depending on the base polymer, it can exhibit thermal performance between 90° and 260°C (in continuous service)
- Combination of electrostatic dissipation, high robustness and heat resistance
- Unique ability to withstand high voltage dielectric breakdown (> 100V)

## APPLICATIONS

- Bushings and switches for test equipment
- Holder for electronic components
- Manufacturing and handling of sensitive electronic components such as integrated circuits, hard disks and circuit boards
- Material Handling Applications
- High-speed electronic printing components
- Reproduction Equipment



CHEMICAL RESISTANCE



ELECTRICAL INSULATION



WEAR RESISTANCE



SLIDING PROPERTIES



IMPACT AO RESISTANCE

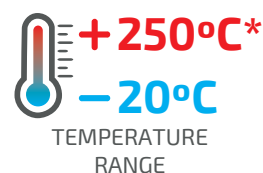

TEMPERATURE RANGE

\*continuously (20.000H)

# SEMITRON® ESd 410 C

**Amorphous plastic**, with excellent mechanical performance up to 200°C (for short periods), SEMITRON® ESd 410C provides solutions at high temperatures. In addition, SEMITRON® ESd 410C exhibits excellent dimensional stability (low coefficient of linear thermal expansion and low water absorption), ideal for handling equipment in the electrical, electronic or semiconductor industries.

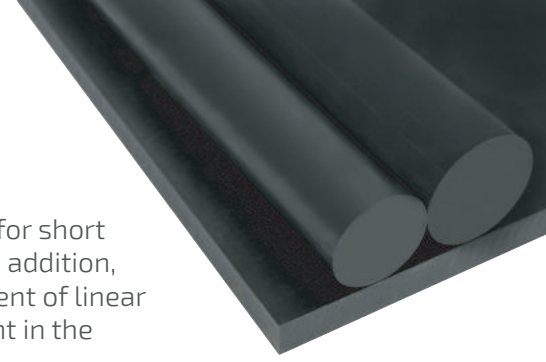

## MAIN CHARACTERISTICS

- Permanent static dissipative
- Dissipates static loads (5kV)
- Its composition does not contain any metal or graphite powder
- Low stress when machining with reduced tolerances
- High robustness and stiffness
- Low moisture absorption

## APPLICATIONS

- Holders used in the transport of integrated circuits
- Manufacturing and handling of sensitive electronic components such as hard disks and circuit boards
- Material Handling Applications
- High-speed electronic printing components
- Reproduction Equipment



CHEMICAL RESISTANCE



ELECTRICAL INSULATION



WEAR RESISTANCE



SLIDING PROPERTIES



IMPACT RESISTANCE

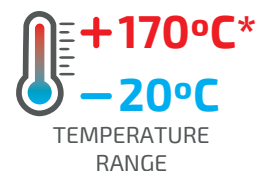

\*continuously (20.000H)

## ROUND RODS

DIAMETER (mm) <sup>(1)(2)</sup>	STANDARD LENGTH	SEMITRON® ESd 410C	
		KG/PIECE <sup>(3)</sup>	STOCK
9.53	305	0.03	○
12.70	305	0.05	○
15.88	305	0.09	○
19.05	305	0.12	○
25.40	305	0.22	○
31.75	305	0.34	○
38.10	305	0.49	○
47.63	203	0.77	○
76.20	153	1.34	○
111.13	153	2.34	○

- (1): all dimensions shown correspond to minimum values  
 (2): for intermediate diameters not listed, please consult us  
 (3): theoretical weights, based on nominal dimensions and mean density

## PLATES

THICKNESS (mm) <sup>(1)(2)</sup>	SEMITRON® ESd 410C		SEMITRON® ESd 500 HR		SEMITRON® ESd 520 HR	
	KG/PIECE <sup>(3)</sup>	STOCK	KG/PIECE <sup>(3)</sup>	STOCK	KG/PIECE <sup>(3)</sup>	STOCK
Standard size 305 x 305 mm <sup>(1)</sup>						
9.53	1.25	○	2.02	○	1.68	○
12.70	1.97	●	2.70	○	1.87	○
15.88	2.08	○	3.38	○	2.33	○
19.05	2.50	○	4.05	○	2.80	●
25.40	3.33	●	5.40	○	3.73	○
31.75	4.16	○	6.76	○	4.95	○
38.10	5.00	○	8.11	○	5.60	●
44.45	5.83	●	9.46	○	-	-
50.80	6.66	○	10.80	○	-	-
Standard size 305 x 610 mm <sup>(1)</sup>						
9.53	2.50	●	-	-	-	-
12.70	3.79	●	-	-	-	-
15.88	4.17	○	-	-	-	-
19.05	5.00	○	-	-	-	-
25.40	6.66	○	-	-	-	-

- (1): all dimensions shown correspond to minimum values  
 (2): for intermediate thicknesses not listed, please consult us  
 (3): theoretical weights, based on nominal dimensions and mean density



SPECIFIC EQUIPMENT TO ENSURE  
CUTTING INTEGRITY!

- Standard; generally available from stock
- Semi-standard; generally not available from stock
- Non-standard; generally not available from stock, manufactured to order and subject to special conditions



# TECHTRON® HPV PPS

**Semi-crystalline plastic,** TECHTRON® HPV PPS shows an excellent combination of wear and abrasion resistance properties, load ability and dimensional stability when exposed to chemical agents and high temperatures. This material applies where PA, POM, PET, PEI and PSU do not work and where PI, PEEK and PAI materials are oversized, with TECHTRON® HPV PPS being a more economical solution.



## MAIN CHARACTERISTICS

- High maximum service air temperature (220°C in continuous service and 260°C in short periods)
- High creep resistance and high hardness even at high temperatures
- High chemical resistance and hydrolysis resistance
- Excellent wear and abrasion resistance
- Very good dimensional stability
- Good dielectric properties and electrical insulation
- Intrinsic flame resistance
- Excellent resistance to high energy radiation (gamma rays and X-rays)
- Good resistance to UV rays
- Super low moisture absorption

## APPLICATIONS

- Pump housings subjected to chemical environments
- Support rings on chemical and mechanical polishing equipment
- Protection boards for industrial printers
- Bushings for solvent extraction conveyors (sugars, oils, etc.)
- Industrial drying ovens
- Conditions where there are no lubrication possibilities
- Bearings and rollers
- Components of pumps, valves and compressors
- Electrical insulation systems



CHEMICAL RESISTANCE



ELECTRICAL INSULATION



WEAR RESISTANCE



SLIDING PROPERTIES



IMPACT RESISTANCE

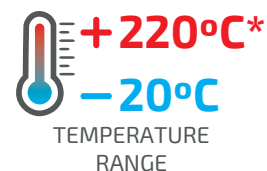

\*continuously (20.000H)

## ROUND RODS

DIAMETER (mm)	TOLERANCES (mm)		KG/PIECE <sup>(1)</sup>	STOCK
Standard length 3000 mm <sup>(2)</sup>				
10	+0.1	+0.5	0.37	●
16	+0.2	+0.9	0.95	●
20			1.46	●
25	+0.2	+1.2	2.30	●
30			3.27	●
36	+0.2	+1.6	4.71	●
40			5.79	●
50	+0.3	+2.0	9.06	●
56			11.31	●
60	+0.3	+2.5	13.05	●
80	+0.4	+3.0	23.10	●
90	+0.5	+3.4	29.25	●
100	+0.6	+3.8	36.15	◐
Other standard lengths 1000 mm <sup>(2)(3)</sup>				

Other measures available on request, subject to special conditions

(1): average production weights

(2): tolerances in length -0 / +3%

(3): non-standard dimensions for diameters greater than 60mm

Tubes available on request.

## PLATES

THICKNESS (mm)	TOLERANCES (mm)		KG/PIECE <sup>(1)</sup>	STOCK
Standard size 525 x 3000 mm <sup>(2)(3)</sup>				
5	+0.2	+0.7	13.17	●
6			15.54	○
8	+0.2	+0.9	20.55	●
10			25.29	●
Standard size 625 x 3000 mm <sup>(2)(3)</sup>				
12	+0.3	+1.5	36.90	◐
16			48.00	●
20			59.25	●
25			73.20	●
30			89.40	●
35	+0.5	+2.5	103.35	○
40			117.30	●
45			131.25	○
50			145.35	●

Other measures available on request, subject to special conditions

(1): average production weights

(2): tolerances in width +5 / +25mm, length -0 / +3%

(3): non-standard sizes for thicknesses over 25mm

VERSATILITY AND AVAILABILITY  
IN THE MANUFACTURING OF  
**LARGE AND COMPLEX PARTS.**

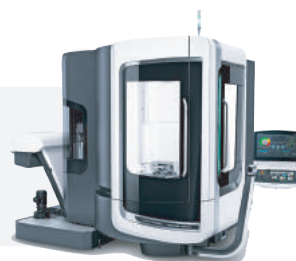

● Standard: generally available from stock  
◐ Semi-standard: generally not available from stock  
○ Non-standard: generally not available from stock, manufactured to order and subject to special conditions

# HIGH-PERFORMANCE PLASTICS TECHNICAL DATASHEET

PROPERTIES	TEST METHODS	UNITS	DURATRON® T4203/T4503 PAI	DURATRON® T4301/T4501 PAI	DURATRON® CU60 PBI	PEI 1000	FLUOROSINT® 207	FLUOROSINT® 500
COLOR	-	-	YELLOW	BLACK	BLACK	AMBER TRANSLUCENT	WHITE	IVORY
DENSITY	ISO 1183-1	g/cm <sup>3</sup>	1.41	1.45	1.30	1.27	2.30	2.32
WATER ABSORPTION								
AFTER 24/96H IMMERSION IN WATER OF 23°C <sup>1</sup>	ISO 62	mg	29/55	26/48	60/112	16/34	-	-
AFTER 24/96H IMMERSION IN WATER OF 23°C <sup>1</sup>	ISO 62	%	0.35/0.67	0.30/0.55	0.74/1.37	0.19/0.40	-	-
AT SATURATION IN AIR OF 23°C / 50% RH	-	%	2.5	1.9	7.5	0.70	<0.1	<0.1
AT SATURATION IN WATER OF 23°C	-	%	4.4	3.8	14	1.30	1-2	1.5-2.5
<b>THERMAL PROPERTIES</b>								
MELTING TEMPERATURE (DSC, 10°C/MIN)	ISO 11357-1/-3	°C	NA	NA	NA	NA	327	327
GLASS TRANSITION TEMPERATURE (DSC, 20°C/MIN) <sup>2</sup>	ISO 11357-1/-2	°C	280	280	415	215	-	-
THERMAL CONDUCTIVITY AT 23°C	-	W/(K.m)	0.26	0.54	0.40	0.24	-	0.77
COEFFICIENT OF LINEAR THERMAL EXPANSION								
AVERAGE VALUE BETWEEN 23-100°C	-	m/(m.K)	40 x 10 <sup>-6</sup>	35 x 10 <sup>-6</sup>	25 x 10 <sup>-6</sup>	50 x 10 <sup>-6</sup>	85 x 10 <sup>-6</sup>	50 x 10 <sup>-6</sup>
AVERAGE VALUE BETWEEN 23-150°C	-	m/(m.K)	40 x 10 <sup>-6</sup>	35 x 10 <sup>-6</sup>	25 x 10 <sup>-6</sup>	50 x 10 <sup>-6</sup>	90 x 10 <sup>-6</sup>	55 x 10 <sup>-6</sup>
AVERAGE VALUE ABOVE 150°C	-	m/(m.K)	50 x 10 <sup>-6</sup>	40 x 10 <sup>-6</sup>	35 x 10 <sup>-6</sup>	60 x 10 <sup>-6</sup>	155 x 10 <sup>-6</sup>	85 x 10 <sup>-6</sup>
TEMPERATURE OF DEFLECTION UNDER LOAD								
METHOD A 1.8 MPA	ISO 75-1/-2	°C	280	280	425	195	100	130
MAXIMUM ALLOWABLE SERVICE TEMPERATURE IN AIR								
FOR SHORT PERIODS <sup>3</sup>	-	°C	270	270	500	200	280	280
CONTINUOUSLY (MIN. 20.000H) <sup>4</sup>	-	°C	250	250	310	170	260	260
MINIMUM SERVICE TEMPERATURE <sup>5</sup>	-	°C	-50	-20	-50	-50	-50	-20
FLAMMABILITY <sup>6</sup>								
"OXYGEN INDEX"	ISO 4589-1/-2	%	45	44	58	47	≥95	≥95
ACCORDING TO UL94 (1.5/3MM DE ESPESSURA)	-	-	V-0/V-0	V-0/V-0	V-0/V-0	V-0/V-0	V-0/V-0	V-0/V-0
<b>MECHANICAL PROPERTIES AT 23°C<sup>7</sup></b>								
TENSION TEST <sup>8</sup>								
TENSILE STRESS AT YIELD/TENSILE STRESS AT BREAK	ISO 527-1/-2	MPa	150/-	NA/110	NA/130	129/-	10/-	7/-
TENSILE STRENGTH <sup>9</sup>	ISO 527-1/-2	MPa	150	110	130	129	10	7
TENSILE STRAIN AT BREAK <sup>9</sup>	ISO 527-1/-2	%	20	5	3	13	>50	15
TENSILE MODULUS OF ELASTICITY <sup>10</sup>	ISO 527-1/-2	MPa	4200	5500	6000	3500	1450	1750
COMPRESSION TEST <sup>11</sup>								
COMPRESSIVE STRESS AT 1/2/5% NOMINAL STRAIN <sup>10</sup>	ISO 604	MPa	34/67/135	39/72/130	58/118/280	31/61/137	10.5/15/20	12/19/25
CHARPY IMPACT STRENGTH - UNNOTCHED <sup>2</sup>	ISO 179-1/1eU	KJ/m <sup>2</sup>	NO BREAK	45	20	NO BREAK	30	8
CHARPY IMPACT STRENGTH - NOTCHED	ISO 179-1/1eA	KJ/m <sup>2</sup>	15	4	2.5	3.5	7.5	4.5
BALL INDENTATION HARDNESS <sup>13</sup>	ISO 2039-1	N/mm <sup>2</sup>	200	200	375	165	40	60
ROCKWELL HARDNESS <sup>13</sup>	ISO 2039-2	-	E 80 (M 120)	M 106 (E 70)	E 120	M 115	R 50	R 55
<b>ELECTRICAL PROPERTIES AT 23°C</b>								
ELECTRIC STRENGTH <sup>14</sup>	IEC 60243-1	kV/mm	24	-	28	27	8	11
VOLUME RESISTIVITY	IEC 60093	Ohm.cm	> 10 <sup>14</sup>	> 10 <sup>13</sup>	> 10 <sup>14</sup>	> 10 <sup>14</sup>	> 10 <sup>13</sup>	> 10 <sup>13</sup>
SURFACE RESISTIVITY	ANSI/ESD STM 11.11	Ohm/sq.	> 10 <sup>13</sup>	> 10 <sup>13</sup>	> 10 <sup>13</sup>	> 10 <sup>13</sup>	> 10 <sup>13</sup>	> 10 <sup>13</sup>
RELATIVE PERMITTIVITY ε : A 100HZ	IEC 60250	-	4.2	6.0	3.3	3.0	-	-
RELATIVE PERMITTIVITY ε : A 1MHZ	IEC 60250	-	3.9	5.4	3.2	3.0	2.65	2.85
DIELECTRIC DISSIPATION FACTOR TAN δ : A 100HZ	IEC 60250	-	0.026	0.037	0.001	0.002	-	-
DIELECTRIC DISSIPATION FACTOR TAN δ : A 1MHZ	IEC 60250	-	0.031	0.042	-	0.002	0.008	0.008
COMPARATIVE TRACKING INDEX (CTI)	IEC 60112	-	175	175	-	175	-	-

NOTE: 1 g/cm<sup>3</sup> = 1000 kg/m<sup>3</sup> ; 1 MPa = 1 N/mm<sup>2</sup> ; 1 KV/mm = 1 MV/m

**(1)** According to method 1 of iso 62 and done on discs ø 50x3 mm **(2)** The figures given for this properties are only attributed to amorphous rather than semi-crystalline materials. **(3)** For short exposure periods only (a few hours ) in applications where only very low loads are applied to the material. **(4)** Temperature which it resists for a minimum period of 20,000 hours. After this time, there is a decrease of about 50% in tensile strength compared to the original value. The given temperature values are based on the thermal oxidation degradation which causes a reduction of the properties. In the meantime, the maximum permissible service temperature depends in many cases essentially on the deduction and magnitude of the mechanical stresses to which the material is subject. **(5)** As the impact strength decreases with decreasing temperature, the minimum permissible service temperature is determined by the extent of impact to which the material is subjected. The values given are based on unfavorable impact conditions and can not therefore be considered absolute limits. **(6)** These assessments are derived from the technical specifications of the manufacturers of the raw materials and do not allow the determination of the behavior of the materials under fire conditions. There is no yellow card for these formats.

# HIGH-PERFORMANCE PLASTICS TECHNICAL DATASHEET

KETRON® PEEK 1000	KETRON® PEEK CA30	KETRON® PEEK GF30	KETRON® PEEK HPV	PSU 1000	SEMITRON® 410 C	SEMITRON® ESd 500 HR	SEMITRON® ESd 520 HR	TECHTRON® HPV PPS
BEIGE/BLACK	BLACK	BEIGE	BLACK	AMBER TRANSLUCENT	BLACK	WHITE	KHAKI GREY	DEEP BLUE
1.31	1.40	1.51	1.45	1.24	1.41	2.30	1.58	1.42
5/10	4/9	5/10	4/9	19/38	-	-	56/110	1/2
0.06/0.12	0.05/0.11	0.05/0.10	0.05/0.11	0.24/0.48	-	-	0.60/1.18	0.01/0.02
0.20	0.16	0.16	0.16	0.30	0.60	< 0.1	2.6	0.05
0.45	0.35	0.35	0.35	0.80	1.10	1 - 2	4.6	0.20
340	340	340	340	NA	NA	327	NA	280
-	-	-	-	190	215	-	280	-
0.25	0.92	0.43	0.78	0.26	0.35	-	0.34	0.30
50 x 10 <sup>-6</sup>	25 x 10 <sup>-6</sup>	30 x 10 <sup>-6</sup>	35 x 10 <sup>-6</sup>	55 x 10 <sup>-6</sup>	40 x 10 <sup>-6</sup>	85 x 10 <sup>-6</sup>	35 x 10 <sup>-6</sup>	50 x 10 <sup>-6</sup>
55 x 10 <sup>-6</sup>	25 x 10 <sup>-6</sup>	30 x 10 <sup>-6</sup>	40 x 10 <sup>-6</sup>	55 x 10 <sup>-6</sup>	45 x 10 <sup>-6</sup>	90 x 10 <sup>-6</sup>	35 x 10 <sup>-6</sup>	60 x 10 <sup>-6</sup>
130 x 10 <sup>-6</sup>	55 x 10 <sup>-6</sup>	65 x 10 <sup>-6</sup>	85 x 10 <sup>-6</sup>	70 x 10 <sup>-6</sup>	45 x 10 <sup>-6</sup>	155 x 10 <sup>-6</sup>	40 x 10 <sup>-6</sup>	100 x 10 <sup>-6</sup>
160	260	230	195	170	200	100	280	115
310	310	310	310	180	200	280	270	260
250	250	250	250	150	170	260	250	220
-50	-20	-20	-20	-50	-20	-50	-20	-20
35	40	40	43	30	47	≥95	48	44
V-0/V-0	V-0/V-0	V-0/V-0	V-0/V-0	HB/HB	V-0/V-0	V-0/V-0	V-0/V-0	V-0/V-0
115/-	NA/144	80/NA	NA/78	88/-	NA/62	10/-	NA/83	NA/78
115	144	80	78	88	62	10	83	78
17	3.5	4.5	3	10	2	> 50	3	3.5
4300	9200	7000	5900	2850	5850	1450	5500	4000
38/75/140	69/125/170	54/103/155	46/80/120	25/49/101	44/76/114	10.5/15/20	42/80/145	33/65/105
NO BREAK	50	25	25	NO BREAK	20	30	20	25
3.5	5	3	3	3.5	4	7.5	4	4
210	310	250	215	115	-	40	2.50	160
M 105	M 102	M 100	M 85	M 89	M 115	R 50	M 110 (E73)	M 82
24	-	24	-	30	-	-	-	24
> 10 <sup>14</sup>	< 10 <sup>5</sup>	> 10 <sup>14</sup>	-	> 10 <sup>14</sup>	10 <sup>4</sup> - 10 <sup>6</sup>	10 <sup>10</sup> - 10 <sup>12</sup>	10 <sup>10</sup> - 10 <sup>12</sup>	> 10 <sup>14</sup>
> 10 <sup>13</sup>	< 10 <sup>5</sup>	> 10 <sup>13</sup>	-	> 10 <sup>13</sup>	10 <sup>4</sup> - 10 <sup>6</sup>	10 <sup>10</sup> - 10 <sup>12</sup>	10 <sup>10</sup> - 10 <sup>12</sup>	> 10 <sup>13</sup>
3.2	-	3.2	-	3.0	-	-	-	3.3
3.2	-	3.6	-	3.0	3.0	3.1	5.8	3.3
0.001	-	0.001	-	0.001	-	-	-	0.003
0.002	-	0.002	-	0.003	0.002	0.075	0.18	0.003
150	-	175	-	150	-	-	-	100

(7) Most of the figures given by the mechanical properties of the extruded materials are mean values of the tests done on specimens machined with ø 40-60 mm. With the exception of hardness tests, the best specimens were taken from an area between the center and outer diameter, with their length in the longitudinal direction (parallel to the direction of extrusion).

(8) Specimen testing: Type 1b. (9) Speed test: 5 or 50 mm / min. (10) Speed test: 1 mm / min. (11) Test specimens: cylinders ø 8x16 mm. (12) Pendulum used: 4J. (13) Test on 10 mm thick specimens. (14) Test on 1 mm thick specimens.

The dielectric strength of the Ketron PEEK 1000 (black) PPSU 1000 black may be considerably lower than the figures listed in the table referring to non-black materials. It should be noted that the values of the compression properties of the Duratron 4503 PAI and 4501 PAI alloys may differ significantly.



PROPERTIES	TEST METHODS	UNITS	PVDF
COLOR	-	-	NATURAL
DENSITY	ISO 1183	g/cm <sup>3</sup>	1.78
WATER ABSORPTION	ISO 62	%	0.04
MOISTURE ABSORPTION	ISO 62	%	0.01
<b>THERMAL PROPERTIES</b>			
GLASS TRANSITION TEMPERATURE VST/B/50	ISO 306	°C	138
GLASS TRANSITION TEMPERATURE VST/A/50	ISO 306	°C	160
DEFORMATION TEMPERATURE HDT/B	ISO 75	°C	145
DEFORMATION TEMPERATURE HDT/A	ISO 75	°C	104
COEFFICIENT OF LINEAR THERMAL EXPANSION	ISO 11359	K <sup>-1</sup> *10 <sup>-4</sup>	1.3
THERMAL CONDUCTIVITY AT 20°C	ISO 22007-4	W/(m*K)	0.13
GLASS TRANSITION TEMPERATURE	ISO 3146	°C	-40
MELTING TEMPERATURE	ISO 3146	°C	171
FLAMMABILITY <sup>6</sup>			
"OXYGEN INDEX"	ASTM D2863	%	44
ACCORDING TO UL94 (1.5/3MM THICKNESS)	-	-	V-0
<b>MECHANICAL PROPERTIES</b>			
TENSILE STRESS AT YIELD	ISO 527	MPa	58
ELONGATION AT YIELD	ISO 527	%	17
TENSILE STRESS AT BREAK	ISO 527	MPa	46
ALONGAMENTO NA RUTURA	ISO 527	%	29
ROCKWELL HARDNESS	ISO 2039	MPa	120
SHORE HARDNESS	ISO 868		80
TENSION TEST	ISO 178	MPa	80
MODULUS OF ELASTICITY	ISO 527	MPa	2125
<b>ELECTRICAL PROPERTIES</b>			
VOLUME RESISTIVITY	IEC 60093	Ω*cm	≥ 10 <sup>10</sup>
SURFACE RESISTIVITY	IEC 60093	Ω	≥ 10 <sup>13</sup>
CONSTANT DIELECTRIC AT 1MHz (εr)	IEC 60250	-	7
DIELECTRIC DISSIPATION FACTOR (tanδ)	IEC 60250	-	0.24
DIELECTRIC STRENGTH	IEC 60243-1	kV/mm	27
RESISTANCE TO SURFACE DISCHARGE	IEC 60112	V	CTI 600

## DYNAMIC STROKE COEFFICIENT

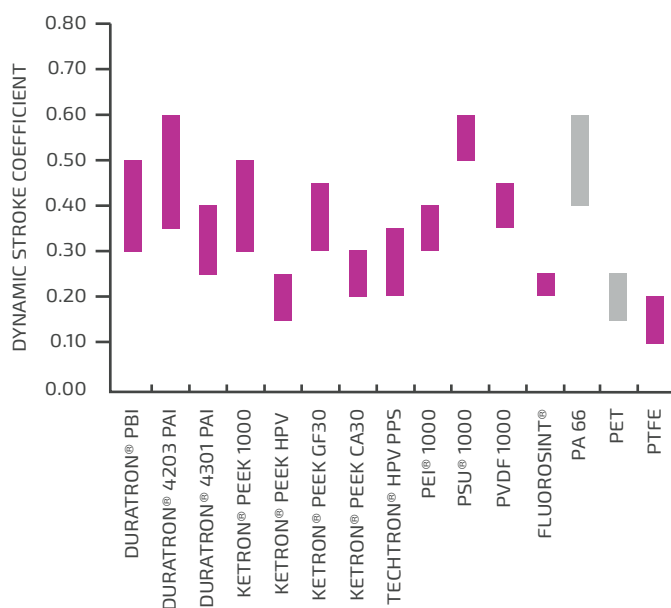

### TEST CONDITIONS

- Pressure: 3 MPa
- Sliding speed: 0.33 m / s
- Surface roughness of C35 steel surface coupling: Ra = 0.7 - 0.9 μm
- Total working distance: 28 km
- Normal environment (air, 23°C / 50% RH)
- Non-lubricated operation

HIGH-PERFORMANCE PLASTICS

MAXIMUM ALLOWABLE SERVICE TEMPERATURE IN AIR



CAPTION

■ MAXIMUM SERVICE TEMPERATURE CONTINUOUSLY  
 ■ MAXIMUM SERVICE TEMPERATURE FOR SHORT PERIODS

ELECTRICAL STRENGTH

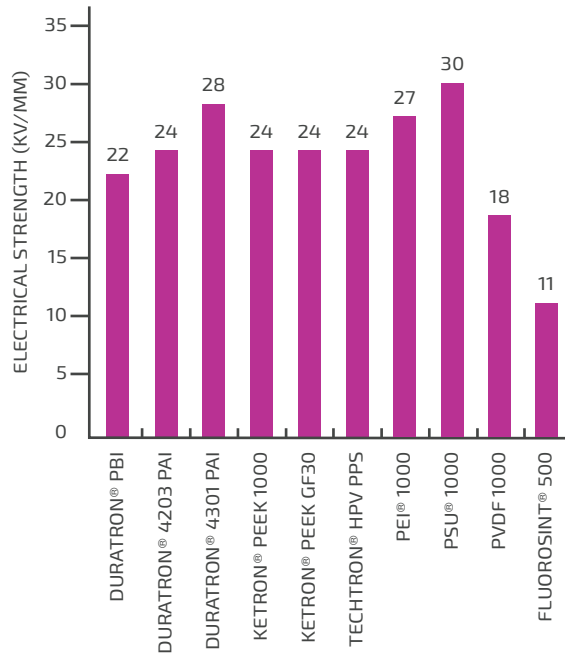

WEAR RESISTANCE

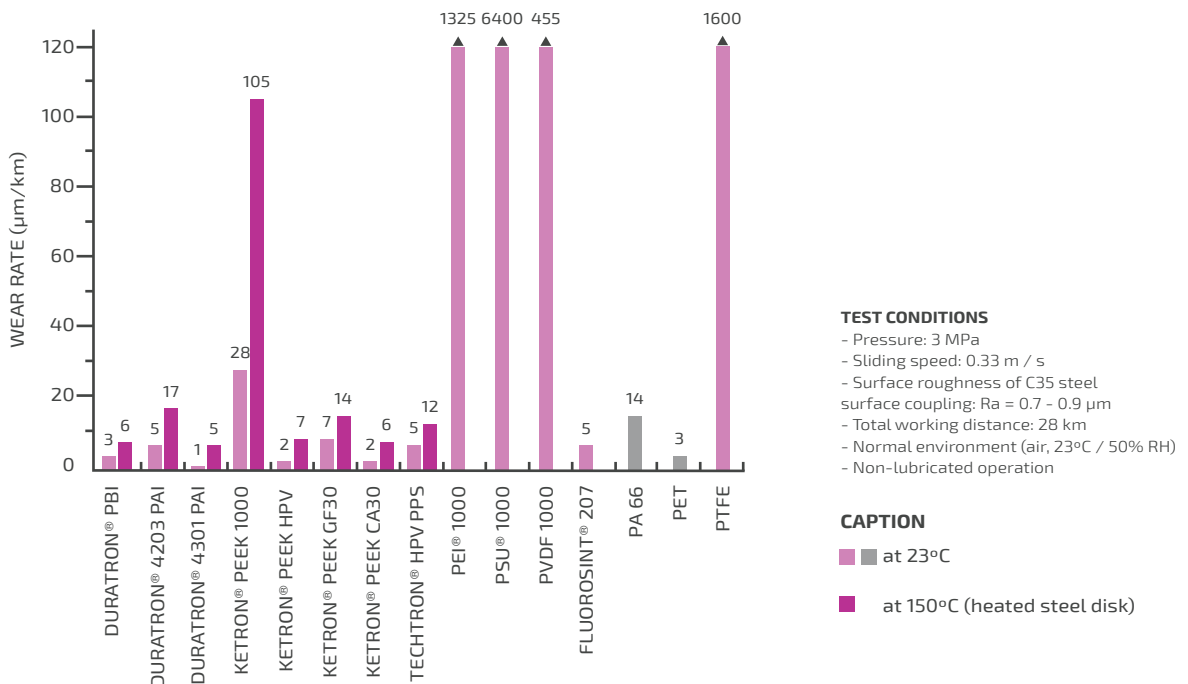

TEST CONDITIONS

- Pressure: 3 MPa  
 - Sliding speed: 0.33 m / s  
 - Surface roughness of C35 steel surface coupling: Ra = 0.7 - 0.9 µm  
 - Total working distance: 28 km  
 - Normal environment (air, 23°C / 50% RH)  
 - Non-lubricated operation

CAPTION

■ at 23°C  
 ■ at 150°C (heated steel disk)

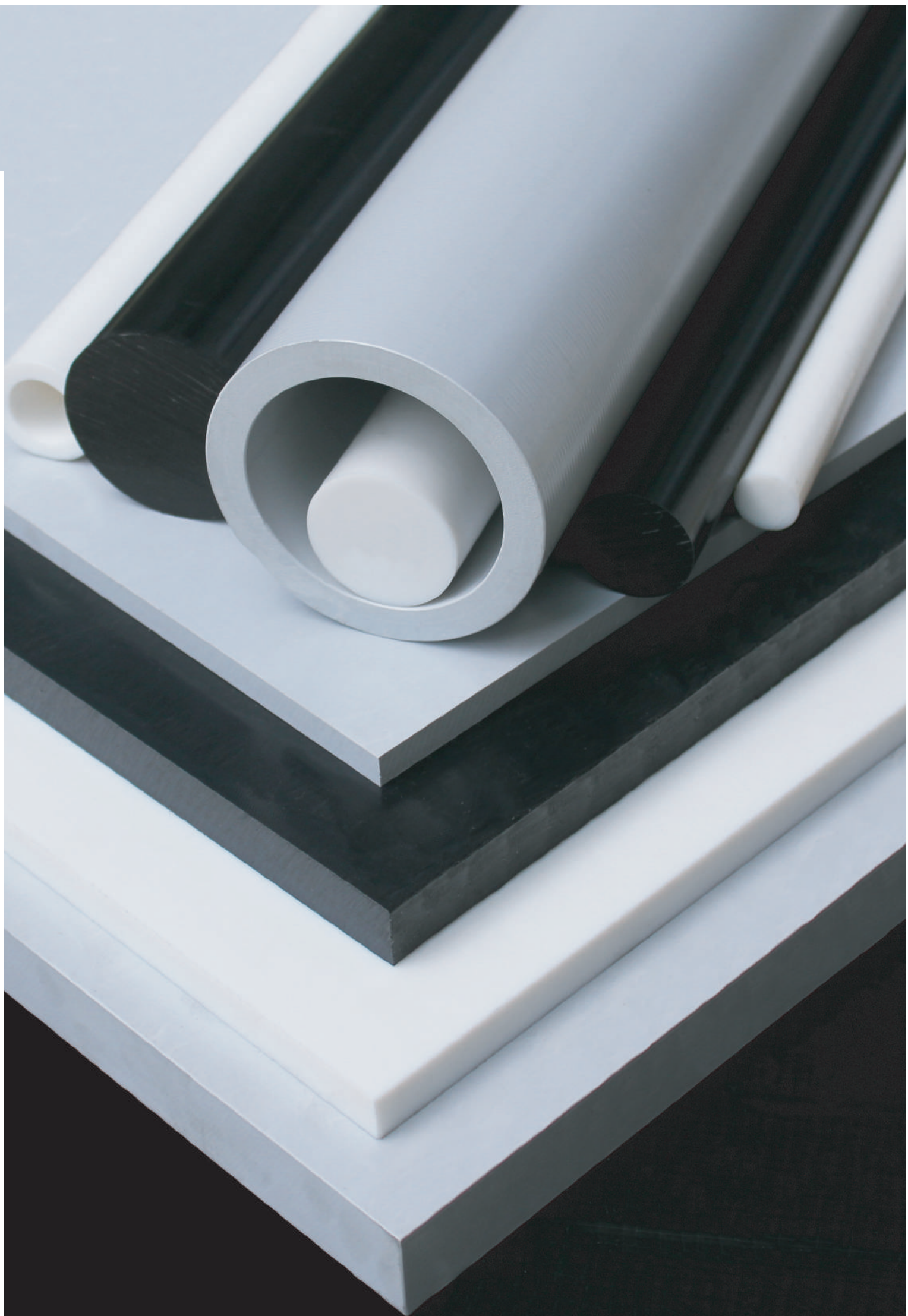



# ERTALYTE®

PET

ERTALYTE®

Ertalyte®		58
Ertalyte® TX		59
Technical Data		62



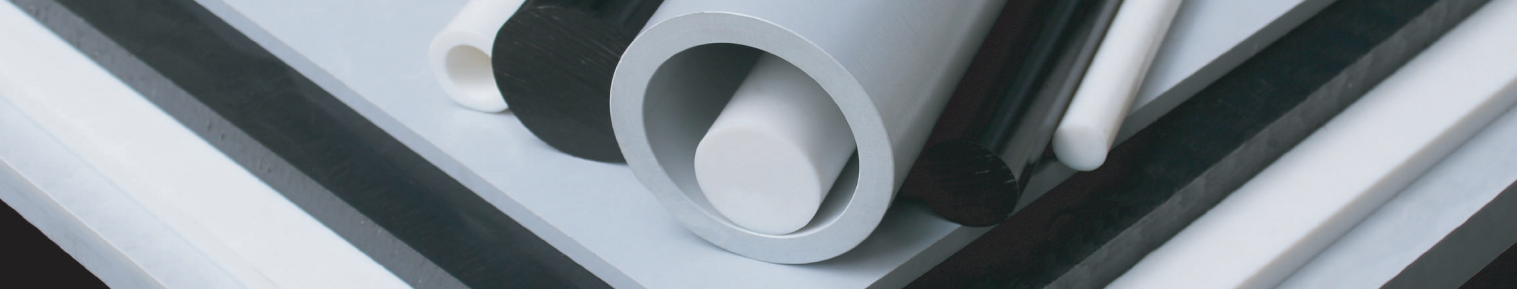

# INTRODUCTION TO ERTALYTE®

## ADVANTAGES OF ERTALYTE®

- Excellent resistance to wear
- Low coefficient of dynamic friction (0.25-0.35)
- Good resistance to UV rays
- Very good dimensional stability (low moisture absorption and low CLTE: 60.10-6 m/(m.K))
- Very good resistance to fluency
- Good resistance to acids (pH below 1)
- Physiologically inert

## ERTALYTE® TX vs ERTALYTE®

- Better wear resistance
  - Lower and more constant dynamic friction coefficient (0.15-0.25)
- High pressure-velocity capabilities (up to twice as high PV limit)
- Lower anti-slip sensitivity
  - Lower tensile strength and compression

## CAUTION WHEN USED IN:

- Applications in water of > 55°C in continuous service (restricted by the limit of hydrolysis resistance)
- Applications with alkaline media (pH > 9)
- Parts subjected to high impact



# MAIN CHARACTERISTICS OF ERTALYTE®

PLASTICS	IMPACT RESISTANCE	WEAR RESISTANCE	SLIDING PROPERTIES	CHEMICAL REISTANCE	ELECTRICAL INSULATION	TEMPERATURE		
						MIN	MAX*	MAX**
ERTALYTE®	POOR	GOOD	GOOD	GOOD	FAIR	-20°	100°	160°
ERTALYTE® TX	POOR	EXCELLENT	EXCELLENT	GOOD	FAIR	-20°	100°	160°

\*Continuously \*\*For shor periods

## FOOD CONTACT



PLASTICS	UE ACC. (EU) 10/2011	USA FDA (21 CFR)	FOOD GRADE
ERTALYTE®	YES	YES (Natural)	YES
ERTALYTE® TX	YES	YES	YES

## CHEMICAL RESISTANCE

CHEMICAL RESISTANCE AT 23°C	ERTALYTE®	ERTALYTE® TX
Weak acids (diluted)	+	+
Strong acids / Oxidizing chemicals	+/- /+/-	+/- /+/-
Weak alkalis (diluted)	+	+
Strong alkalis	-	-
Hot water (> 80°C) / Steam	+ /+	+ /+
Esters (e.g.: ethyl acetate)/Ketones (e.g.: acetone)	+ /+	+ /+
Aromatic hydrocarbons (e.g. benzene, toluene)	+	+
Aliphatic hydrocarbons (e.g. hexane, octane)	+	+
Lubricating oils and greases	+	+

+ Resistant (in general acceptable useful life)  
 ± Partially resistant (limited useful life)  
 - Non-resistant

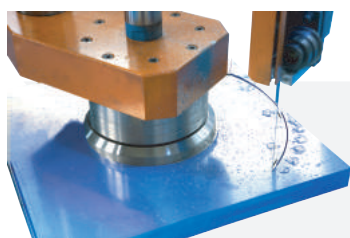

DIFFERENT TYPES OF HIGH PRECISION CUTTING **AT YOUR DISPOSAL!**



PET ● ○

# ERTALYTE®

**Semi-crystalline plastic**, it contains specific properties that, in the virgin state, make the ERTALYTE® a particularly suitable material for precision mechanical parts exposed to high loads and subjected to high wear.

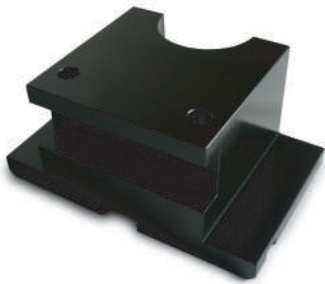

## MAIN CHARACTERISTICS

- High mechanical resistance
- Very good creep resistance
- Low and uniform coefficient of friction
- Excellent wear resistance (better than polyamides)
- Very good dimensional stability (better than Ertacetal®)
- Physiologically inert
- Excellent stain resistance (consistent white appearance)
- Better acid resistance than polyamides and polyacetals
- Good chemical resistance and robustness
- Very low water absorption

## APPLICATIONS

- Bushings, guides and casters
- No-impact low module gears
- Scrapers for food and similar products
- Precision parts
- Dental prosthetics
- Insulating parts
- Components for pumps in the food industry
- Components for pharmaceutical testing equipment



CHEMICAL RESISTANCE



ELECTRICAL INSULATION



WEAR RESISTANCE



SLIDING PROPERTIES



IMPACT RESISTANCE

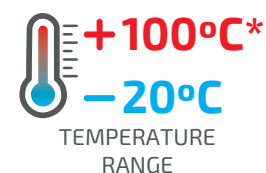

TEMPERATURE RANGE

\*continuously (20.000H)



**Semi-crystalline plastic**, is a material that contains a solid lubricant dispersed uniformly. Its specific formulation produces internal lubrication. It is particularly recommended for bearings and parts with friction movement. It offers higher wear resistance, lower coefficient of friction and higher PV values than normal ERTALYTE®.

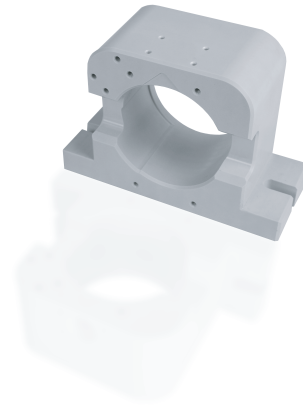

## MAIN CHARACTERISTICS

- Exceptional wear resistance (higher than Ertalyte®)
- Lower and more uniform coefficient of friction
- It stands out in high pressure and high-speed situations
- Self-lubricating composition, therefore less sensitive to the "stick-slip" effect
- Physiologically inert
- Very low thermal expansion
- Very low moisture absorption

## APPLICATIONS

- Bushings with high speeds
- Guides
- Wear parts with heavy loads

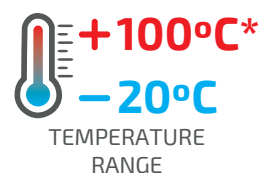
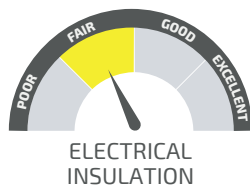

\*continuously (20.000H)





### SHEETS

THICKNESS (mm)	TOLERANCES (mm) <sup>(1)</sup>		ERTALYTE®	
			KG/PIECE <sup>(2)</sup>	STOCK
Standard size 1000 x 2000 mm <sup>(3)</sup>				
2	-0.15	+0.15	5.74	*
3	-0.20	+0.20	8.60	*
4			11.40	*
5	-0.25	+0.25	14.25	*
6	-0.30	+0.30	17.10	*
Other standard sizes 1000 x 1000 mm <sup>(3)</sup>				

\* available on request; please check production time and minimum quantity  
 (1): tolerances according to DIN EN 15860  
 (2): average weights of production  
 (3): tolerances in length -0 / + 3mm

### ROUND RODS

DIAMETERS (mm)	TOLERANCES (mm) <sup>(1)</sup>		ERTALYTE®			ERTALYTE® TX	
			KG/PIECE <sup>(2)</sup>	NATURAL	BLACK	KG/PIECE <sup>(1)</sup>	STOCK
Standard length 3000 mm <sup>(3)</sup>							
10	+0.1	+0.5	0.35	●	○	0.37	●
12	+0.2	+0.7	0.52	●	○	0.53	●
14			0.70	○	○	0.72	○
15			0.80	●	○	0.82	○
16			0.91	●	○	0.93	●
18			1.14	●	○	1.17	○
20	1.40	●	●	1.44	●		
22	+0.2	+0.9	1.71	●	○	1.76	○
25			2.19	●	●	2.25	●
28			2.73	○	○	2.81	○
30			3.12	●	●	3.21	●
32			3.57	●	○	3.66	○
36	+0.2	+1.1	4.50	●	●	4.62	●
40	+0.3	+1.3	5.52	●	●	5.70	●
45			7.02	●	○	7.23	●
50			8.64	●	●	8.88	●
56			10.80	●	○	11.10	○
60			12.45	●	●	12.78	●
65	+0.3	+1.6	14.55	●	○	14.97	○
70	+0.4	+2.0	16.86	●	○	17.34	●
75			19.44	○	○	20.01	○
80			22.08	●	●	22.71	●
85			24.96	○	○	25.68	○
90			27.93	●	●	28.74	●
100	+0.6	+2.5	34.50	●	○	35.55	○
110	+0.7	+3.0	41.85	●	○	43.05	○
120	+0.8	+3.5	49.95	●	○	51.45	●
125			54.15	●	○	55.65	○
130	+0.9	+3.8	58.65	●	●	60.30	○
140			67.80	●	○	69.75	○
150			78.00	●	○	80.25	●
160	+1.1	+4.5	88.80	●	-	91.20	○
170	+1.2	+5.0	100.35	●	-	103.20	○
180			112.20	●	-	115.50	○
190	+1.3	+5.5	125.25	●	-	128.85	○
200			138.45	●	-	142.50	○
210			152.70	●	-	-	-
Other standard lengths 1000 mm <sup>(3)</sup>							

(1): tolerances according to DIN EN 15860 (2): average weights of production (3): tolerances in length -0 / + 3%

- Standard: generally available from stock
- Semi-standard: generally not available from stock
- Non-standard: generally not available from stock, manufactured to order and subject to special conditions

## PLATES

THICKNESS (mm)	TOLERANCES (mm) <sup>(1)</sup>		ERTALYTE®		ERTALYTE® TX		
			KG/PIECE <sup>(2)</sup>	NATURAL	BLACK	KG/PIECE <sup>(2)</sup>	STOCK
Standard size 610 x 3000 mm <sup>(3)</sup>							
8	+0.2	+0.9	22.77	●	○	23.43	●
10			28.11	●	●	28.92	●
12	+0.3	+1.5	34.35	●	○	35.40	●
15			42.30	●	○	43.50	●
16			45.00	●	●	46.35	○
18			50.40	○	○	51.75	○
20			55.65	●	●	57.30	●
25			68.85	●	●	70.80	●
30	+0.5	+2.5	83.70	●	●	86.10	●
35			96.90	●	○	99.75	○
40			110.25	●	●	113.40	●
45			123.45	○	○	127.05	○
50			136.80	●	●	140.70	●
60	+0.5	+3.5	164.70	●	●	169.35	●
70			191.25	○	○	196.65	○
80	+0.5	+5.0	219.75	●	●	226.05	●
90			246.30	○	○	253.35	○
100			272.85	●	○	280.65	●
Other standard sizes 610 x 1000 mm <sup>(3)</sup>							

Other 1000x3000 Ertalyte® plates (natural and black) available on request and subject to special conditions  
 (1): tolerances according to DIN EN 15860  
 (2): average weights of production  
 (3): tolerances in length -0 / + 3%; in width + 5 / + 25mm

## TUBES

DIAM. (mm) Ø O.D. x Ø I.D.	TOLERANCES <sup>(1)</sup> (mm)			ERTALYTE®		ERTALYTE® TX	
	Ø O.D.	Ø I.D.		KG/PIECE <sup>(2)</sup>	NATURAL	KG/PIECE <sup>(2)</sup>	STOCK
Standard length 3000 mm <sup>(3)</sup>							
30 x 20	+0.4	+1.1	-0.4 -1.1	1.92	○	1.98	○
36 x 20	+0.6	+2.0	-0.6 -2.0	3.48	○	3.60	●
40 x 20				4.53	○	4.68	●
45 x 30				4.41	○	4.56	○
50 x 30				6.06	○	6.24	●
55 x 45	+0.8	+2.5	-0.8 -2.5	4.44	●	4.59	●
60 x 30				10.02	○	10.32	○
60 x 40				7.80	○	8.01	○
65 x 50				7.23	○	7.44	○
70 x 50				9.57	○	9.84	○
80 x 40	+0.8	+3.0	-0.8 -3.0	17.61	○	18.09	○
80 x 60				11.16	○	11.46	○
90 x 50				21.27	○	21.90	○
90 x 70	+1.2	+3.6	-1.6 -5.0	13.68	○	14.07	○
100 x 50				27.81	○	28.59	○
100 x 80				15.42	○	15.84	○
115 x 70	+1.5	+4.5	-2.0 -6.5	32.10	○	33.00	○
125 x 50				47.85	○	49.20	○
140 x 70				54.00	○	55.50	○
160 x 80				70.65	○	72.75	○
200 x 100	+2.0	+6.0	-2.5 -8.5	109.50	○	112.50	○
Other standard lengths 1000 mm <sup>(3)</sup>							

Other measures available on request, subject to special conditions  
 (1): tolerances according to DIN EN 15860  
 (2): average weights of production  
 (3): tolerances in length -0 / + 3%

- Standard: generally available from stock
- Semi-standard: generally not available from stock
- Non-standard: generally not available from stock, manufactured to order and subject to special conditions



# PET TECHNICAL DATASHEET

PROPERTIES	TEST METHODS	UNITS	ERTALYTE®	ERTALYTE® TX
COLOR		-	WHITE/BLACK	PALE GREY
DENSITY	ISO 1183-1	g/cm <sup>3</sup>	1.39	1.44
WATER ABSORPTION				
AFTER 24/96H IMMERSION IN WATER OF 23°C <sup>1</sup>	ISO 62	mg	6/13	5/11
AFTER 24/96H IMMERSION IN WATER OF 23°C <sup>1</sup>	ISO 62	%	0.07/0.16	0.06/0.13
AT SATURATION IN AIR OF 23°C / 50% RH	-	%	0.25	0.23
AT SATURATION IN WATER OF A 23°C	-	%	0.50	0.47
THERMAL PROPERTIES <sup>2</sup>				
MELTING TEMPERARUTE (DSC, 10°C/MIN)	ISO 11357-1/-3	°C	245	245
GLASS TRANSITION TEMPERATURE (DSC, 20°C/MIN) <sup>3</sup>	ISO 11357-1/-3	°C	-	-
THERMAL CONDUCTIVITY A 23°C	-	W/(K.m)	0.29	0.29
COEFFICIENT OF LINEAR THERMAL EXPANSION				
AVERAGE VALUE BETWEEN 23-60°C	-	M/(m.K)	60 x 10 <sup>-6</sup>	65 x 10 <sup>-6</sup>
AVERAGE VALUE BETWEEN 23-100°C	-	M/(m.K)	80 x 10 <sup>-6</sup>	85 x 10 <sup>-6</sup>
TEMPERATURE OF DEFLECTION UNDER LOAD				
METHOD A 1.8 MPA	+ ISO 75-1/-2	°C	80	75
MAXIMUM ALLOABLE SERVICE TEMPERATURE IN AIR				
FOR SHORT PERIODS <sup>4</sup>	-	°C	160	160
CONTINUOUSLY: FOR 5.000/20.000H <sup>5</sup>	-	°C	115/100	115/100
MINIMUM SERVICE TEMPERATURE <sup>6</sup>	-	°C	-20	-20
FAMMABILITY <sup>7</sup>				
"OXYGEN INDEX"	ISO 4589-1/-2	%	25	25
ACCORDING TO UL94 (3/6MM DE ESPESSURA)	-	-	HB/HB	HB/HB
MECHANICAL PROPERTIES AT 23°C <sup>8</sup>				
TENSION TEST <sup>9</sup>				
TENSILE STRESS AT YIELD/AT BREAK <sup>10</sup>	+ ISO 527-1/-2	MPa	90/-	76/-
TENSILE STRESS AT YIELD/AT BREAK <sup>10</sup>	++ ISO 527-1/-2	MPa	90/-	76/-
TENSILE STRENGTH <sup>10</sup>	+ ISO 527-1/-2	MPa	90	76
TENSILE STRAIN AT YIELD <sup>10</sup>	+ ISO 527-1/-2	%	4	4
TENSILE STRAIN AT BREAK <sup>10</sup>	+ ISO 527-1/-2	%	15	5
TENSILE STRAIN AT BREAK <sup>10</sup>	++ ISO 527-1/-2	%	15	5
TENSILE MODULUS OF ELASTICITY <sup>11</sup>	+ ISO 527-1/-2	MPa	3500	3300
TENSILE MODULUS OF ELASTICITY <sup>11</sup>	++ ISO 527-1/-2	MPa	3500	3300
COMPRESSION TEST <sup>12</sup>				
COMPRESSIVE STRESS AT 1/2/5% NOMINAL STRAIN <sup>11</sup> +	ISO 604	MPa	33/64/107	31/60/102
CHARPY IMPACT STRENGTH - UNNOTCHED <sup>13</sup>	+ ISO 179-1/1eU	KJ/m <sup>2</sup>	50	30
CHARPY IMPACT STRENGTH - NOTCHED	+ ISO 179-1/1eA	KJ/m <sup>2</sup>	2	2.5
BALL IDENTATION HARDNESS <sup>14</sup>	+ ISO 2039-1	N/mm <sup>2</sup>	170	160
ROCKWELL HARDNESS <sup>14</sup>	+ ISO 2039-2	-	M 96	M 94
ELECTRICAL PROPERTIES AT 23°C				
ELECTRIC STRENGTH <sup>15</sup>	+ IEC 60243-1	kV/mm	22	21
ELECTRIC STRENGTH <sup>15</sup>	++ IEC 60243-1	kV/mm	22	21
VOLUME RESISTIVITY	+ IEC 60093	Ohm.cm	> 10 <sup>14</sup>	> 10 <sup>14</sup>
VOLUME RESISTIVITY	++ IEC 60093	Ohm.cm	> 10 <sup>14</sup>	> 10 <sup>14</sup>
SURFACE RESISTIVITY	+ IEC 60093	Ohm	> 10 <sup>13</sup>	> 10 <sup>13</sup>
SURFACE RESISTIVITY	++ IEC 60093	Ohm	> 10 <sup>13</sup>	> 10 <sup>13</sup>
RELATIVE PERMITTIVITY ε <sub>r</sub> : A 100HZ	+ IEC 60250	-	3.4	3.4
RELATIVE PERMITTIVITY ε <sub>r</sub> : A 100HZ	++ IEC 60250	-	3.4	3.4
RELATIVE PERMITTIVITY ε <sub>r</sub> : A 1MHZ	+ IEC 60250	-	3.2	3.2
RELATIVE PERMITTIVITY ε <sub>r</sub> : A 1MHZ	++ IEC 60250	-	3.2	3.2
DIELECTRIC DISSIPATION FACTOR TAN δ : A 100HZ	+ IEC 60250	-	0.001	0.001
DIELECTRIC DISSIPATION FACTOR TAN δ : A 100HZ	++ IEC 60250	-	0.001	0.001
DIELECTRIC DISSIPATION FACTOR TAN δ : A 1MHZ	+ IEC 60250	-	0.014	0.014
DIELECTRIC DISSIPATION FACTOR TAN δ : A 1MHZ	++ IEC 60250	-	0.014	0.014
COMPARATIVE TRACKING INDEX (CTI)	+ IEC 60112	-	600	600
COMPARATIVE TRACKING INDEX (CTI)	++ IEC 60112	-	600	600

+: values for dry material

++: values referring to material in equilibrium with the standard atmosphere 23°C / 50% rh

(1) According to method 1 of ISO 62 and measured on ø 50x3 mm discs. (2) The elements supplied for this property are for the most part supplied by the manufacturers of the raw materials. (3) The values of this property are only attributed to amorphous rather than semi-crystalline materials. (4) Only for short periods of exposure in applications where only very low loads are applied to the material. (5) Temperature that resists after a period of 5,000 / 20,000 hours. After this time, there is a decrease of about 50% in tensile strength compared to the original value. The given temperature values are based on the thermal oxidation degradation which occurs which causes a reduction of the properties. In the meantime, the maximum permissible service temperature depends in many cases essentially on the deduction and magnitude of the mechanical stresses to which the material is subject. (6) As the impact strength decreases with decreasing temperature, the minimum allowable service temperature is determined by the extent of impact to which the material is subjected. The values given are based on unfavorable impact conditions and can not therefore be considered absolute limits. (7) These assessments derive from the technical specifications of the manufacturers of the raw materials and do not allow the determination of the behavior of the materials under fire conditions. (8) Most of the figures given by the properties of the (+) materials are mean values of the tests done on species machined with ø 40-60 mm. (9) Specimen testing: Type 1b. (10) Speed test: 5 or 50 mm / min. (11) Speed test: 1m / min. (12) Testing specimens: cylinders ø 8 x 16 mm. (13) Pendulum used: 15J. (14) Test on 10 mm thick specimens. (15) Electrode configuration: cylinders ø 25 / ø 75 mm, in transformer oil according to IEC 60296.

Note that the electrical force for the extruded black material can be considerably lower than that of natural material. The possible micro porosity in the center of conserved forms in stock significantly reduces the electric force.

NOTE: 1 g/cm<sup>3</sup> = 1000 kg/m<sup>3</sup> ; 1 MPa = 1 N/mm<sup>2</sup> ; 1 KV/mm = 1 MV/m

PET  
**MAXIMUM ALLOWABLE SERVICE TEMPERATURE IN AIR**



ERTALYTE®

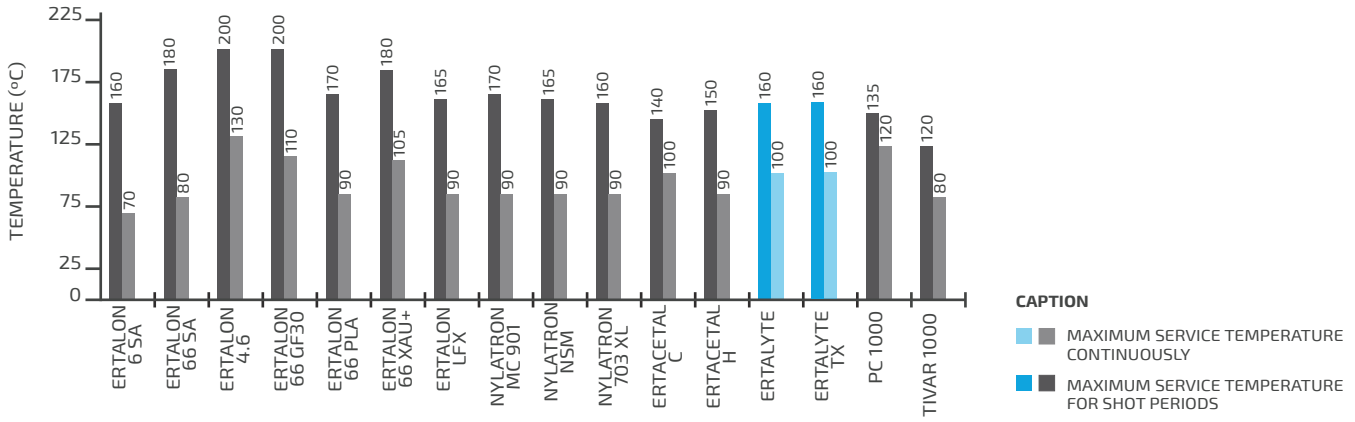

**CAPTION**

- MAXIMUM SERVICE TEMPERATURE CONTINUOUSLY
- MAXIMUM SERVICE TEMPERATURE FOR SHOT PERIODS

**RIGIDITY vs. TEMPERATURE**

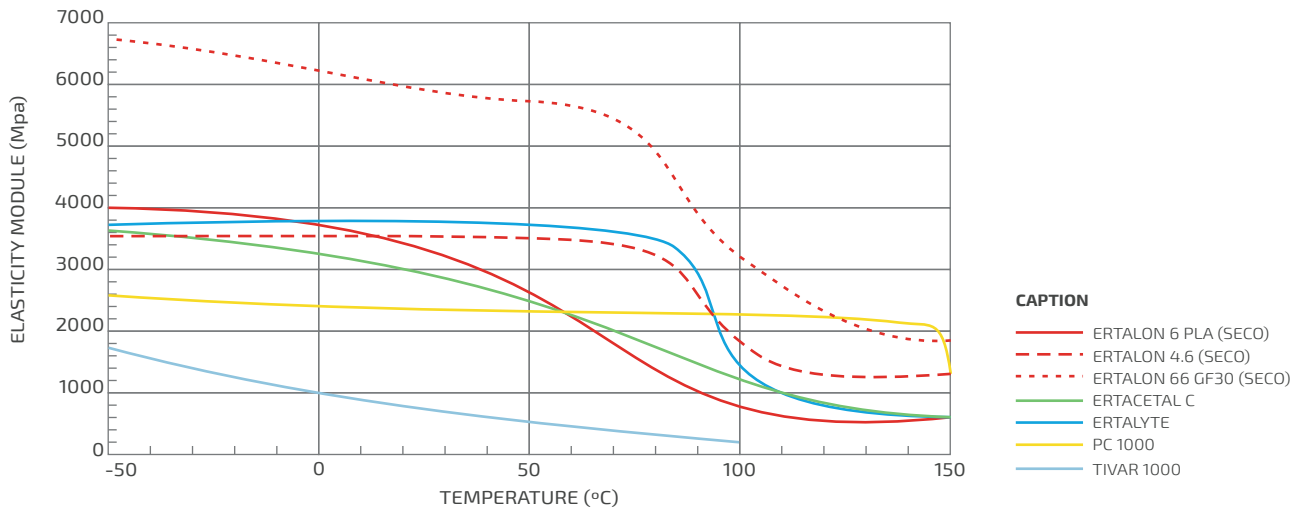

**CAPTION**

- ERTALON 6 PLA (SECO)
- - - ERTALON 4.6 (SECO)
- ... ERTALON 66 GF30 (SECO)
- ERTACETAL C
- ERTALYTE
- PC 1000
- TIVAR 1000

**CHEMICAL RESISTANCE AT 23°C**

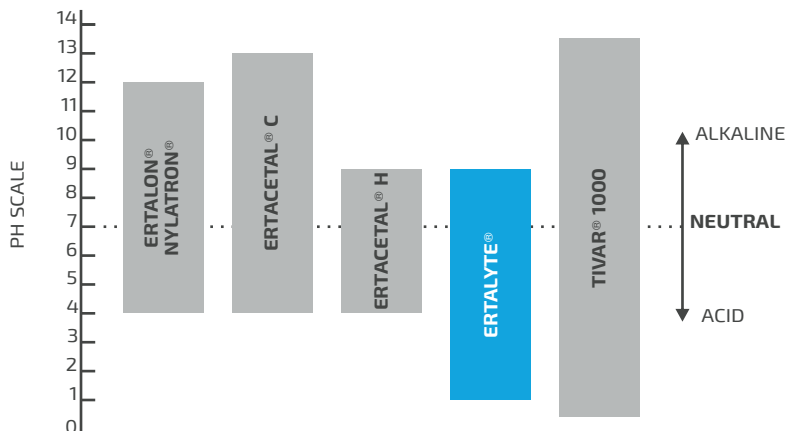



# PET DIMENSIONAL STABILITY

ERTALYTE®

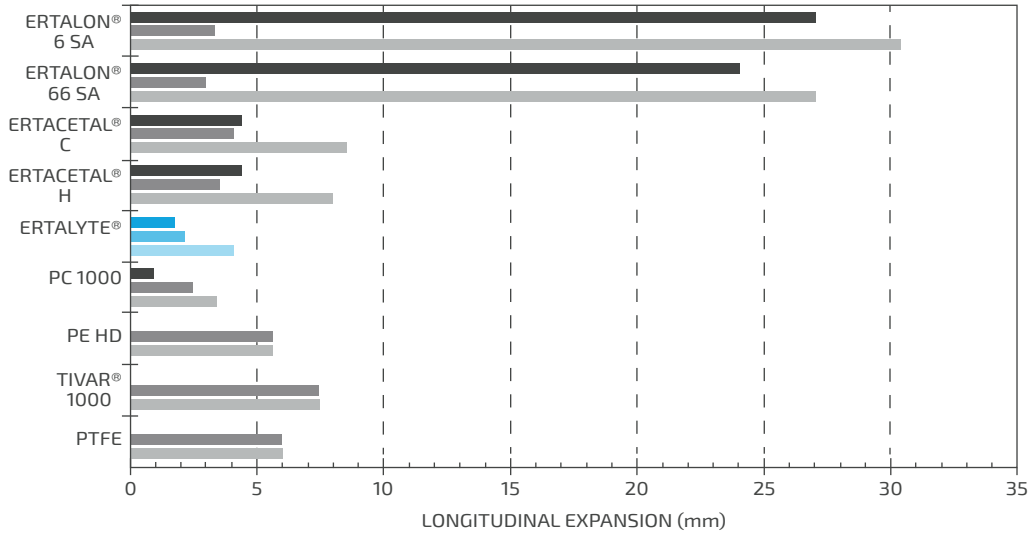

**TEST CONDITIONS**

- Expansion of a long strip of 1,000mm (dry, 23°C) when immersed in water at 60°C

**CAPTION**

- Expansion caused by the absorption of water in complete saturation
- Expansion caused by the increase in temperature from 23°C to 60°C
- Total expansion

## TENSILE STRESS ON ELASTIC LIMIT STRESS/RUPTURE\* AT 23°C (ISO 527)

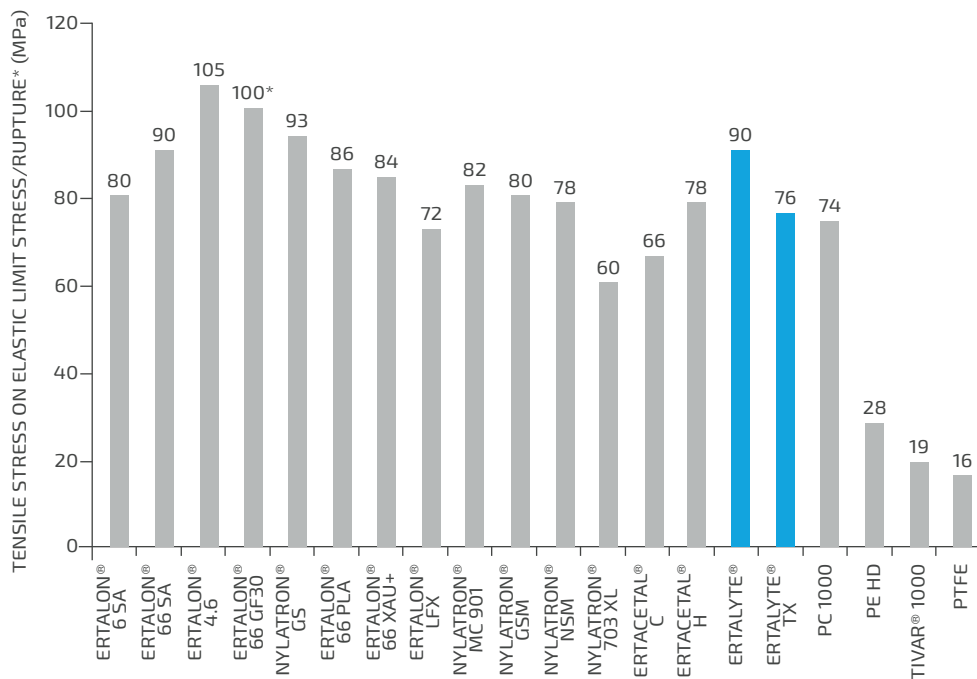

**TEST CONDITIONS**

- Measured on dry samples



# PET WEAR RESISTANCE AT 23°C



ERTALYTE®

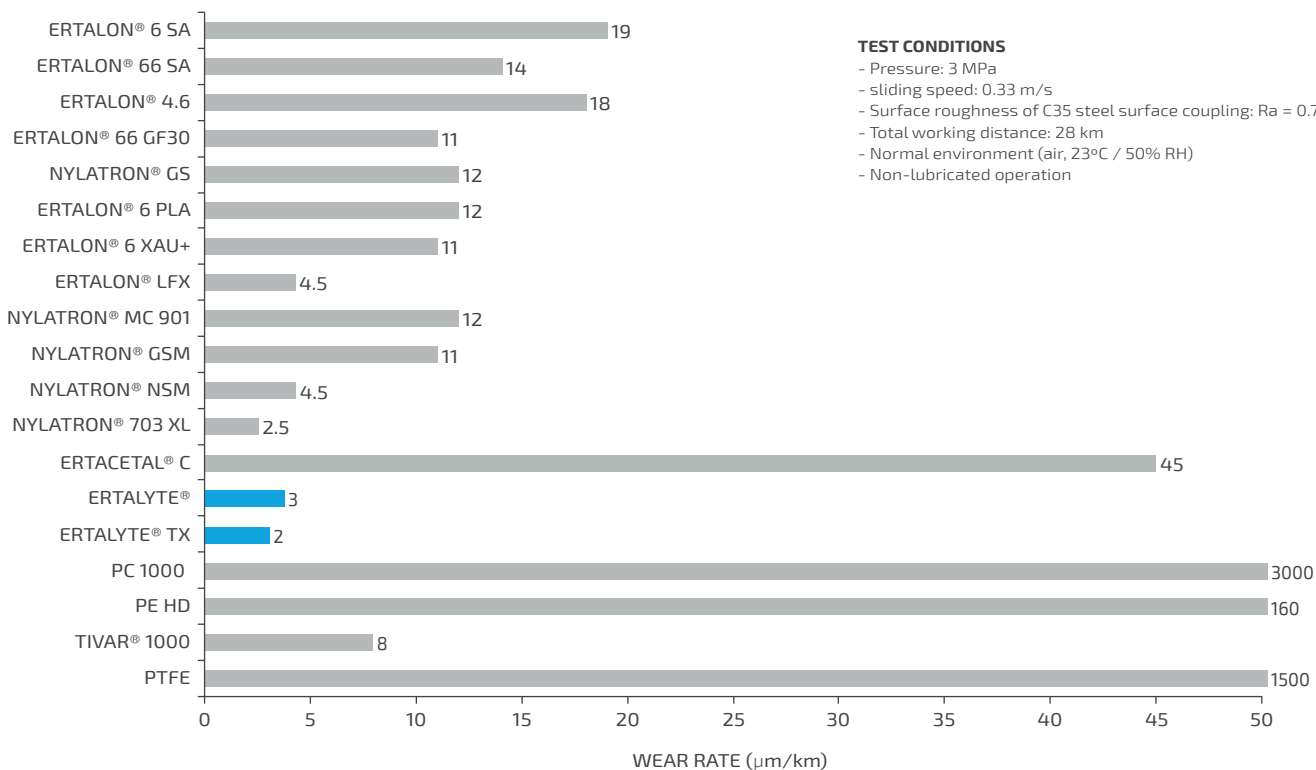

# COMPRESSION STRESS AT 23°C (ISO 604)

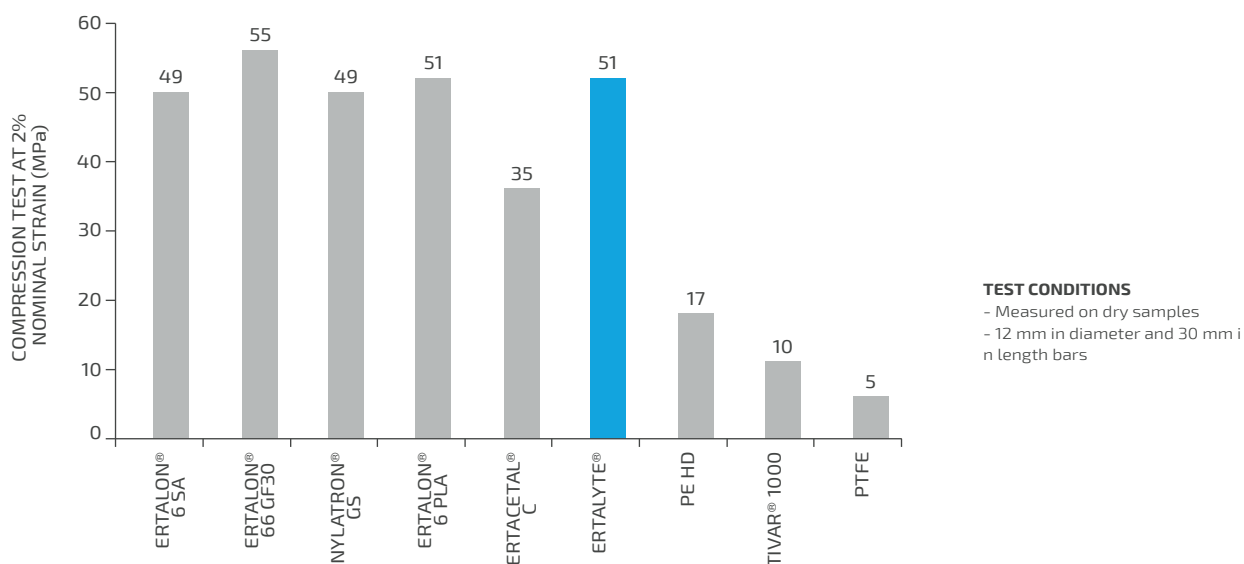



PET

# ROCKWELL HARDNESS M AT 23°C (ISO 2039-2)

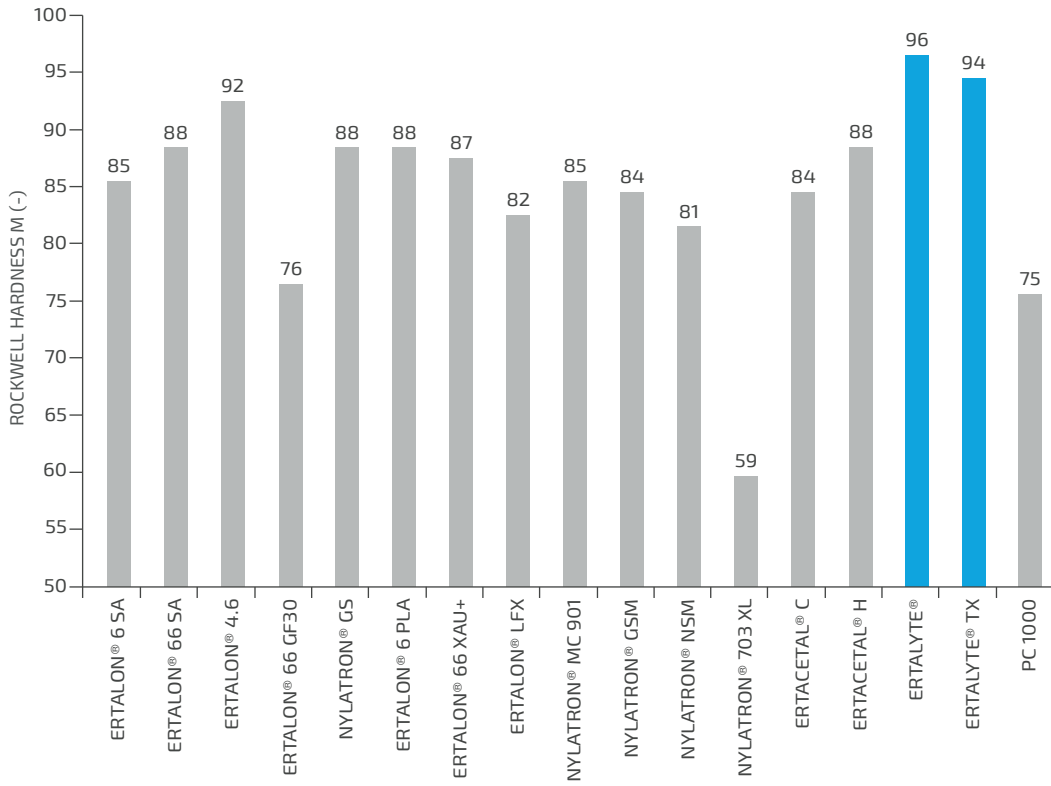

# DYNAMIC FRICTION COEFFICIENT AT 23°C

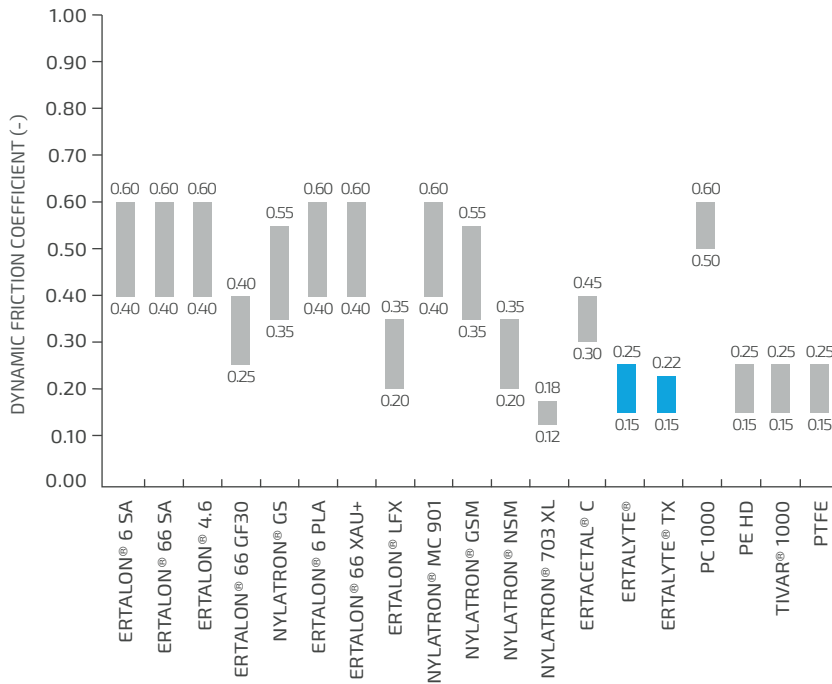

### TEST CONDITIONS

- Pressure: 3 MPa
- sliding speed: 0.33 m/s
- Surface roughness of C35 steel surface coupling: Ra = 0.7 - 0.9 µm
- Total working distance: 28 km
- Normal environment (air, 23°C / 50% RH)
- Non-lubricated operation

# SUNLIGHT RESISTANCE (UV RAYS)

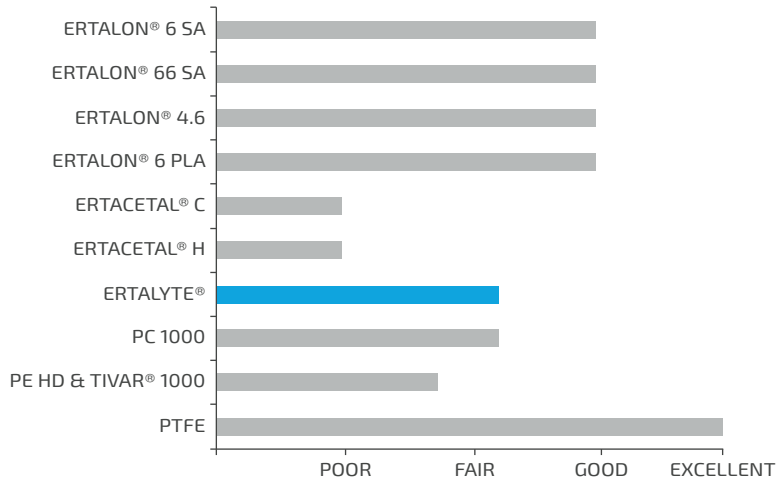

# HYDROLYSIS RESISTANCE

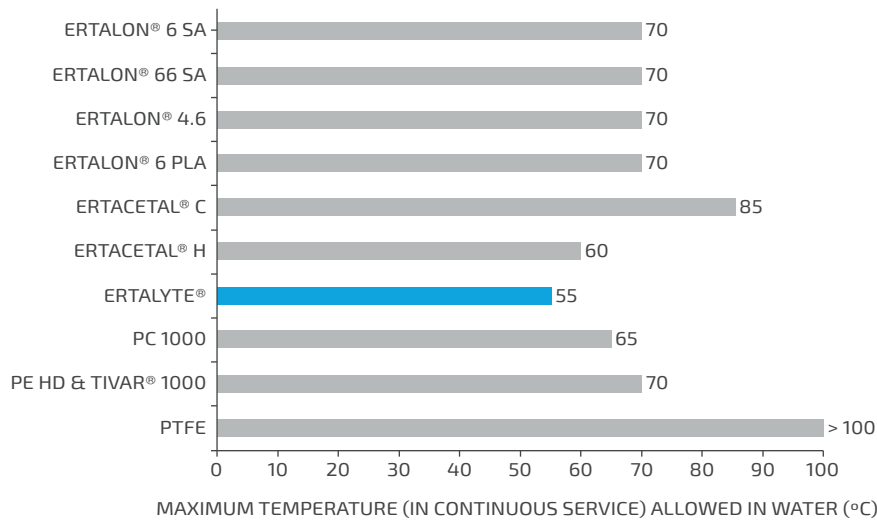

# RESISTANCE AGAINST IONIZING RADIATION (GAMA RAYS)

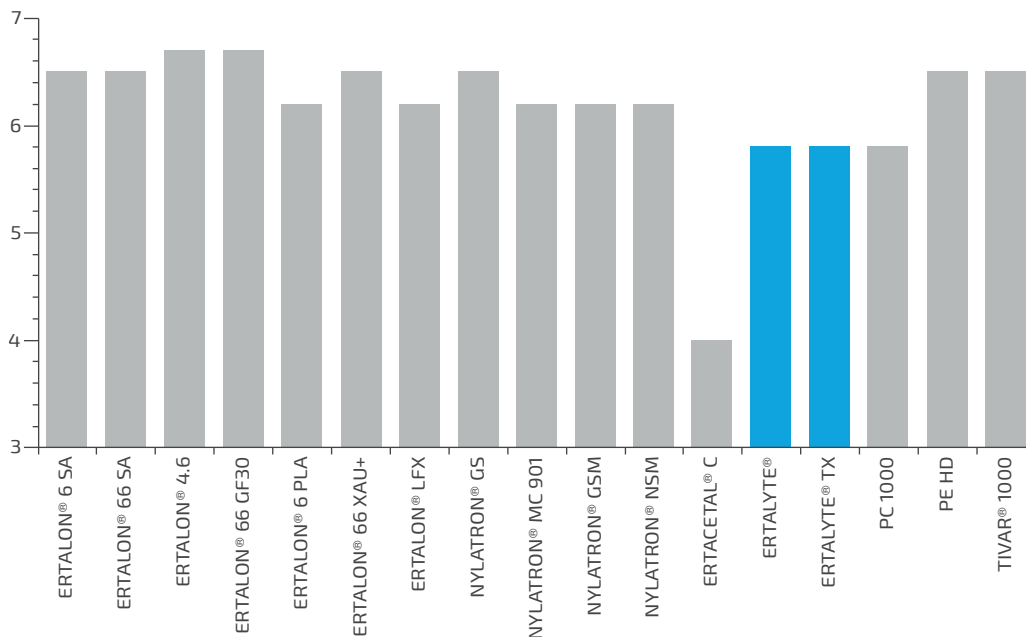

1 Gray = 100 Rad  
 10° Gray = 100 Mrad  
 1 Mrad = 10 kJ/kg

The radiation index (RI) is defined as the logarithm, base 10, of the dose absorbed in the GRAY in which the flexural stress at rupture or flexural tension at rupture of the tested material is reduced to 50% of its original value under irradiation conditions (the most sensitive to radiation)





# ERTALON®/NYLATRON®

PA

ERTALON®  
NYLATRON®

Ertalon® 6 SA		72
Ertalon® 66 SA		73
Ertalon® 4.6		74
Ertalon® 66 GF30		75
Ertalon® 6 PLA		76
Ertalon® 6 XAU+		77
Ertalon® LFX		78
Nylatron® GS		84
Nylatron® GSM		85
Nylatron® NSM		86
Nylatron® MC 901		87
Nylatron® SLG		88
Nylatron® 703 XL		89
Technical Data		92





# INTRODUCTION TO ERTALON®/NYLATRON®

## ADVANTAGES OF ERTALON® / NYLATRON®

- High resistance to impact
- Good resistance to fatigue
- High mechanical damping capacity
- Good resistance to UV rays
- Good resistance against bases (up to pH 12)
- Excellent wear resistance

## CAUTION WHEN USED IN:

- Precision parts (high moisture absorption!)
- Operation in acidic environment (pH <4)
- Bearings subjected to high PV values (pressure-velocity)
- Applications in water temperature above 70°C in continuous service (due to limited resistance to hydrolysis)

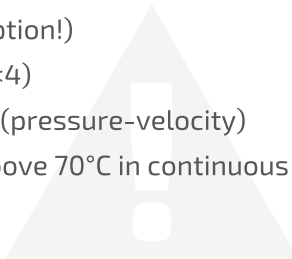

PRECISION MACHINING SERVICES  
**AT YOUR DISPOSAL!**



# MAIN CHARACTERISTICS OF ERTALON®/NYLATRON®

PLASTICS	IMPACT RESISTANCE	WEAR RESISTANCE	SLIDING PROPERTIES	CHEMICAL RESISTANCE	ELECTRICAL INSULATION	TEMPERATURE		
						MIN	MAX*	MAX**
ERTALON® 6 SA	GOOD	GOOD	GOOD	FAIR	GOOD	-40°	70°	160°
ERTALON® 66 SA	FAIR	GOOD	GOOD	FAIR	GOOD	-30°	80°	180°
ERTALON® 4.6	GOOD	EXCELLENT	GOOD	FAIR	GOOD	-40°	130°	200°
ERTALON® 66 GF30	FAIR	EXCELLENT	GOOD	FAIR	GOOD	-20°	110°	200°
ERTALON® 6 PLA	GOOD	GOOD	GOOD	FAIR	GOOD	-30°	90°	170°
ERTALON® 6 XAU+	GOOD	EXCELLENT	GOOD	FAIR	GOOD	-30°	105°	180°
ERTALON® LFX	GOOD	EXCELLENT	EXCELLENT	FAIR	GOOD	-20°	90°	165°
NYLATRON® GS	GOOD	EXCELLENT	GOOD	FAIR	GOOD	-20°	80°	180°
NYLATRON® GSM	GOOD	EXCELLENT	EXCELLENT	FAIR	GOOD	-30°	90°	170°
NYLATRON® NSM	GOOD	EXCELLENT	EXCELLENT	FAIR	GOOD	-30°	90°	165°
NYLATRON® MC 901	EXCELLENT	EXCELLENT	GOOD	FAIR	GOOD	-30°	90°	170°
NYLATRON® SLG	GOOD	EXCELLENT	GOOD	FAIR	GOOD	-20°	90°	165°
NYLATRON® 703 XL	GOOD	EXCELLENT	EXCELLENT	FAIR	GOOD	-20°	90°	160°

\*Continuously \*\*For short periods

## FOOD CONTACT



PLASTICS	UE ACC. (EU) 10/2011	USA FDA (21 CFR)	FOOD GRADE
ERTALON® 6 SA	YES (natural)	YES (natural)	YES (natural)
ERTALON® 66 SA	YES (natural)	YES (natural)	YES (natural)
ERTALON® 4.6	NO	NO	NO
ERTALON® 66 GF30	NO	NO	NO
ERTALON® 6 PLA	YES (natural/blue)	YES (natural/blue)	YES (natural/blue)
ERTALON® 6 XAU+	NO	NO	NO
ERTALON® LFX	NO	NO	NO
NYLATRON® GS	NO	NO	NO
NYLATRON® GSM	NO	NO	NO
NYLATRON® NSM	NO	NO	NO
NYLATRON® MC 901	NO	NO	NO
NYLATRON® SLG	NO	NO	NO
NYLATRON® 703 XL	NO	NO	NO

## CHEMICAL RESISTANCE

CHEMICAL RESISTANCE AT 23°C	ERTALON®							NYLATRON®				
	6 SA	66 SA	4.6	66 GF30	6 PLA	6 XAU+	LFX	GS	GSM	NSM	MC 901	703 XL
Weak acids (diluted)	±	±	±	±	±	±	±	±	±	±	±	±
Strong acids / Oxidizing chemicals	-/-	-/-	-/-	-/-	-/-	-/-	-/-	-/-	-/-	-/-	-/-	-/-
Weak alkalis (diluted)	±	±	±	±	±	±	±	±	±	±	±	±
Strong alkalis	-	-	-	-	-	-	-	-	-	-	-	-
Hot water (> 80°C) / Steam	±/-	±/-	±/-	±/-	±/-	±/-	±/-	±/-	±/-	±/-	±/-	±/-
Esters (e.g.: ethyl acetate)/Ketones (e.g.: acetone)	+/+	+/+	+/+	+/+	+/+	+/+	+/+	+/+	+/+	+/+	+/+	+/+
Aromatic hydrocarbons (e.g. benzene, toluene)	+	+	+	+	+	+	+	+	+	+	+	+
Aliphatic hydrocarbons (e.g. hexane, octane)	+	+	+	+	+	+	+	+	+	+	+	+
Lubricating oils and greases	+	+	+	+	+	+	+	+	+	+	+	+

+ Resistant (in general acceptable useful life)  
 ± Partially resistant (limited useful life)  
 - Non-resistant



PA ● ○

# ERTALON® 6 SA

**Semi-crystalline plastic**, this material offers a great combination of mechanical resistance, wear resistance, stiffness and toughness. These characteristics together with its good electrical insulation capacity and good chemical resistance make this material "universal" for the manufacturing of mechanical and industrial maintenance elements.



## MAIN CHARACTERISTICS

- High mechanical resistance, stiffness and hardness
- Very good after-impact recovery capacity
- Good sliding properties
- Excellent resistance to wear
- Easy machining
- Good fatigue resistance
- Good electrical insulation properties
- High mechanical damping capacity
- Good resistance to high energy radiation (gamma rays and X-rays)

## APPLICATIONS

- Bushings
- Rollers, wheels and casters
- Wear parts
- Separators
- Holders
- Structural parts
- Pulleys
- Sprockets



CHEMICAL RESISTANCE



ELECTRICAL INSULATION



WEAR RESISTANCE



SLIDING PROPERTIES



IMPACT RESISTANCE

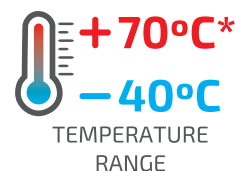

TEMPERATURE RANGE

\*continuously (20.000H)

# ERTALON® 66 SA

**Semi-crystalline plastic**, this material has better mechanical resistance to heat and wear as well as greater rigidity than ERTALON® 6 SA. It also provides excellent creep resistance. However, its impact resistance and mechanical damping capacity are smaller.



## MAIN CHARACTERISTICS

- ◆ Higher mechanical, heat and wear resistance than ERTALON® 6 SA
- ◆ Higher creep resistance
- ◆ Easier machining
- ◆ Lower damping power
- ◆ Good sliding properties
- ◆ Good properties of electrical insulation
- ◆ Good resistance to high energy radiation (gamma rays and X-rays)

## APPLICATIONS

- ◆ Automatic lathes machining
- ◆ High module sprockets
- ◆ Wheels and rollers
- ◆ Bushings
- ◆ Separators
- ◆ Large parts subjected to heavy loads



CHEMICAL RESISTANCE



ELECTRICAL INSULATION



WEAR RESISTANCE



SLIDING PROPERTIES



IMPACT AO RESISTANCE

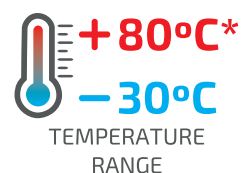

\*continuously (20.000H)



PA ●

# ERTALON® 4.6

**Semi-crystalline plastic**, compared to conventional polyamides, ERTALON® 4.6 is characterized by maintaining its creep resistance over a wider range of temperatures, also having a higher heat resistance over an extended period.

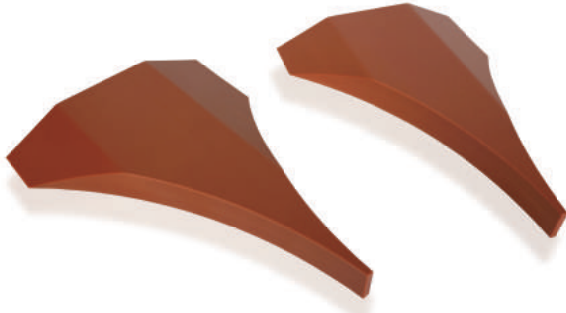
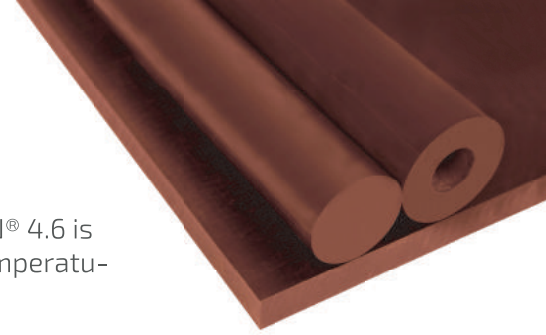

ERTALON®  
NYLATRON®

## MAIN CHARACTERISTICS

- High mechanical, creep and heat resistance for extended periods of time
- Polyamide with higher temperature resistance
- Greater resistance to thermal ageing
- Slight decrease in dimensional stability
- Good sliding properties
- Good properties of electrical insulation
- Excellent wear resistance
- High mechanical damping capacity
- Good resistance to high energy radiation (gamma rays and X-rays)
- Easy machining

## APPLICATIONS

- Applications within a higher range of temperatures (80 - 150°C)
- Applications where the mechanical resistance, creep, stiffness, temperature and wear resistance of PA 6, PA 66, POM and PET are insufficient



CHEMICAL RESISTANCE



ELECTRICAL INSULATION



WEAR RESISTANCE



SLIDING PROPERTIES



IMPACT RESISTANCE

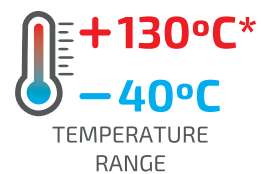

\*continuously (20.000H)



# ERTALON® 66 GF30

**Semi-crystalline plastic**, compared to ERTALON® 66 SA, this polyamide reinforced with 30% glass fibre and stabilized to the heat, offers greater mechanical resistance, stiffness, creep and dimensional stability, maintaining an excellent wear resistance.

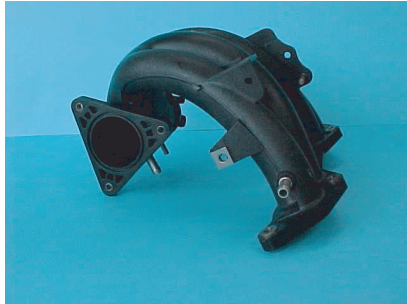

## MAIN CHARACTERISTICS

- ◆ Higher retention of mechanical resistance, stiffness and creep at high temperatures due to FV load
- ◆ Greater dimensional stability (no need for stabilization before the machining process)
- ◆ Good properties of electrical insulation
- ◆ Good sliding properties
- ◆ Excellent wear resistance
- ◆ High mechanical damping capacity
- ◆ Good resistance to high energy radiation (gamma rays and X-rays)
- ◆ Easy machining

## APPLICATIONS

- ◆ Bushings with no rotation
- ◆ Electrical insulators
- ◆ Spinning nozzles
- ◆ Structural parts
- ◆ Prototypes

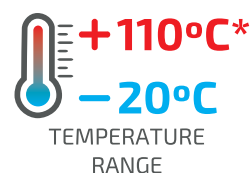
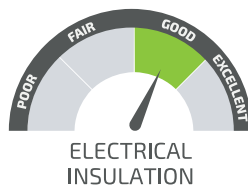

\*continuously (20.000H)



PA ● ○ ●

# ERTALON® 6 PLA

**Semi-crystalline plastic,** ERTALON® 6 PLA is a cast polyamide 6 without additives and with very similar physical qualities to ERTALON® 66 SA. It combines high mechanical resistance, stiffness and hardness with good creep, heat and wear resistance for longer periods of time. Easy machining.

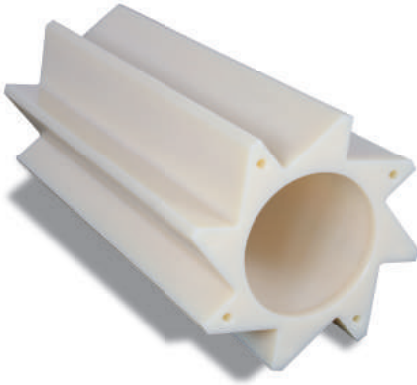

## MAIN CHARACTERISTICS

- Better combination of mechanical resistance, stiffness and hardness with wear resistance
- Low coefficient of friction
- Better dimensional stability
- Good electrical insulation properties
- High mechanical damping capacity
- Good resistance to high energy radiation (gamma rays and X-rays)
- Easy machining

## APPLICATIONS

- High module sprockets
- Wheels and rollers
- Bushings
- Separators
- Large parts subjected to heavy loads



CHEMICAL RESISTANCE



ELECTRICAL INSULATION



WEAR RESISTANCE



SLIDING PROPERTIES



IMPACT RESISTANCE

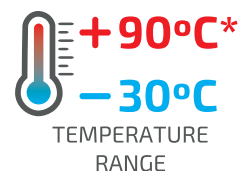

\*continuously (20.000H)

# ERTALON® 6 XAU+

**Semi-crystalline plastic**, ERTALON® 6 XAU + is a heat-stabilized cast polyamide 6 with a very dense and highly crystalline molecular structure. Compared with conventional extruded and cast polyamides, ERTALON® 6 XAU + has a higher heat resistance (less degradation due to thermal oxidation), being able to work during longer periods at temperatures of 15 to 30°C above the temperature of conventional polyamides.



## MAIN CHARACTERISTICS

- ◆ Better wear and creep resistance
- ◆ Greater resistance to thermal ageing
- ◆ Very dense molecular structure
- ◆ Self-lubricating
- ◆ Excellent machinability
- ◆ Good sliding properties
- ◆ Good properties of electrical insulation
- ◆ High mechanical damping capacity
- ◆ Good resistance to high energy radiation (gamma rays and X-rays)

## APPLICATIONS

- ◆ Bushings
- ◆ Mechanical parts subject to wear
- ◆ Specially recommended for mechanical parts subjected to wear at temperatures above 60°C



CHEMICAL RESISTANCE



ELECTRICAL INSULATION



WEAR RESISTANCE



SLIDING PROPERTIES



IMPACT AO RESISTANCE

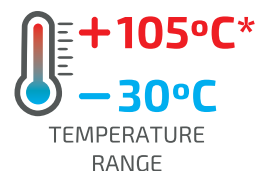

\*continuously (20.000H)



PA ●

# ERTALON® LFX

**Semi-crystalline plastic,** ERTALON® LFX is a self-lubricating cast polyamide 6 (internally lubricated). It has been specifically developed for applications with no lubrication, with large loads and small speeds, thus increasing the possibilities of application of the polyamides. This is because it reduces the coefficient of friction by more than 50% and increases the wear resistance 10 times more than conventional polyamides.

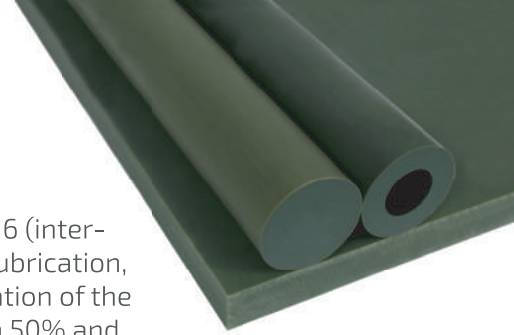

ERTALON®  
NYLATRON®

## MAIN CHARACTERISTICS

- Self-lubricating
- Excellent resistance to wear
- Low coefficient of friction
- Higher PV values (pressure/velocity)
- High mechanical damping capacity
- Good resistance to high energy radiation (gamma rays and X-rays)
- Good sliding properties
- Good thermal insulation properties
- Easy machining

## APPLICATIONS

- Sliding rulers
- Linear motion bushings
- Slip parts with no lubrication and small speeds
- Ore tank holders

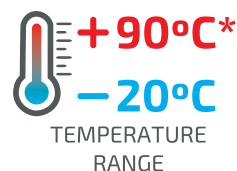
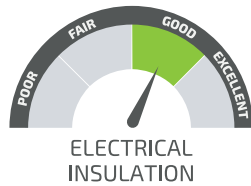
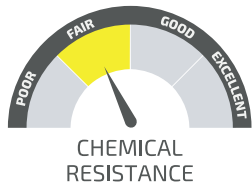

\*continuously (20.000H)



**PLATES**

THICKNESS (mm)	TOLERANCES (mm)		ERTALON® 6 PLA			ERTALON® LFX		ERTALON® 6 XAU+	
			KG/PIECE <sup>(1)</sup>	NATURAL	BLACK	KG/PIECE <sup>(1)</sup>	STOCK	KG/PEÇA <sup>(1)</sup>	STOCK
Standard size 1220 x 3050 mm							610 x 1220 mm		
10	+0.5	+2.5	50.55	●	●	49.85	●	10.05	●
12			59.30	●	●	58.55	●	11.80	●
16			76.85	●	●	75.85	●	15.35	●
20			94.45	●	●	93.25	●	18.85	●
25			116.40	●	●	114.90	●	23.20	●
30	+0.5	+3.0	140.10	●	●	138.20	●	27.90	●
35			162.10	●	●	160.00	●	32.30	●
40			184.10	●	●	181.60	●	36.70	●
45			206.00	●	○	203.30	○	41.05	○
50			228.00	●	○	224.90	●	45.45	●
55	+0.5	+3.5	252.70	○	○	249.30	○	50.35	○
60			274.70	●	●	271.00	●	54.75	○
65			296.47	○	○	292.62	○	59.10	○
70	+0.5	+4.5	318.60	●	○	314.50	●	63.50	○
80			362.50	●	●	357.80	●	72.25	●
90			406.40	●	○	401.20	○	81.00	○
100			450.30	●	○	444.50	●	89.75	●

Ertalon® 6 PLA blue available upon request and subject to special conditions  
(1): average production weights

**TOLERANCES (width x length):**  
 - 610 (0/+10) x 1220 (+10/+20) mm  
 - 1220 (+10/+20) x 2000 (+10/+30) mm  
 - 1220 (+10/+20) x 2440 (+20/+40) mm  
 - 1220 (+10/+20) x 3050 (+20/+40) mm

**PLATES**

THICKNESS (mm)	TOLERANCES (mm) <sup>(1)</sup>		ERTALON® 6 SA			ERTALON® 66 SA			ERTALON® 4.6		ERTALON® 66 GF-30	
			KG/PIECE <sup>(2)</sup>	NATURAL	BLACK	KG/PEÇA <sup>(2)</sup>	NATURAL	BLACK	KG/PEÇA <sup>(2)</sup>	STOCK	KG/PEÇA <sup>(2)</sup>	STOCK
Standard size 610 x 3000 mm <sup>(3)</sup>										625 x 3000 mm <sup>(3)</sup>		
8	+0.2	+0.9	18.84	●	●	18.45	●	○	-	-	-	-
10			23.19	●	●	22.77	●	○	24.15	●	26.52	●
12	+0.3	+1.5	28.02	●	○	27.84	●	○	-	-	-	-
15			34.50	●	●	34.35	●	○	36.45	●	39.90	●
16			36.75	○	○	36.45	●	○	-	-	-	-
18			41.10	○	○	-	-	-	-	-	-	-
20			45.45	●	●	45.15	●	○	47.70	●	52.50	●
25	+0.5	+2.5	56.25	●	●	55.95	●	○	59.10	●	65.10	●
30			68.40	●	●	67.95	●	○	72.00	●	79.20	●
35			79.35	○	○	78.75	○	○	-	-	-	-
40			90.15	●	●	89.55	●	○	94.65	●	104.40	●
45			101.10	○	○	100.35	○	○	500 x 3000 mm <sup>(3)</sup>	-	-	-
50	111.90	●	○	111.15	●	○	96.60	●	129.45	●		
60	+0.5	+3.5	134.70	●	○	133.80	○	○	-	-	155.85	●
70			156.45	○	○	155.40	○	○	-	-	181.05	○
80	+0.5	+5.0	179.85	○	○	178.65	○	○	-	-	208.05	●
90			201.60	○	○	200.25	○	○	-	-	233.10	○
100			223.35	○	○	221.85	○	○	-	-	258.30	●
Other standard sizes 610 x 1000 mm <sup>(3)</sup>										625 x 1000 mm <sup>(3)</sup>		

(1): tolerances according to DIN EN 15860  
 (2): average weights of production  
 (3): tolerances in width + 5 / + 25mm; in length - 0 / + 3%

● Standard: generally available from stock  
 ○ Semi-standard: generally not available from stock  
 ○ Non-standard: generally not available from stock, manufactured to order and subject to special conditions





**SHEETS**

THICKNESS (mm)	TOLERANCES (mm) <sup>(1)</sup>		ERTALON® 6 SA		ERTALON® 66 SA	
			KG/PIECE <sup>(2)</sup>	STOCK	KG/PIECE <sup>(2)</sup>	STOCK
Standard size 1000 x 2000 mm <sup>(3)</sup>						
1.0	-0.10	+0.10	2.34	●	-	-
1.5			3.52	○	-	-
2.0	-0.15	+0.15	4.70	●	4.70	●
2.5			5.88	○	-	-
3.0	-0.20	+0.20	7.04	●	7.04	●
4.0			9.40	●	10.55	○
5.0	-0.25	+0.25	11.75	●	11.75	●
6.0			14.10	●	14.10	●
8.0	+0.20	+0.90	20.40	○	-	-
Other standard sizes 610 x 1000 mm <sup>(3)</sup>						

(1): tolerances according to DIN EN 15860  
(2): average weights of production  
(3): tolerances in length -0 / + 3%

**TUBES**

DIAM. (mm) Ø O.D. x Ø I.D.	TOLERANCES <sup>(1)</sup> (mm)		ERTALON® 6 SA		ERTALON® 66 SA			
	Ø O.D.	Ø I.D.	KG/PIECE <sup>(1)</sup>	NATURAL	KG/PIECE <sup>(1)</sup>	NATURAL		
Standard length 3000 mm <sup>(3)</sup>								
20 x 10			0.94	●	0.94	○		
25 x 12			1.46	●	1.46	○		
25 x 15	+0.4	+1.1	-0.4	-1.1	1.25	●	1.25	○
30 x 15			2.03	●	2.03	○		
30 x 20			1.58	●	1.58	○		
32 x 25			1.49	●	1.49	○		
36 x 17			3.12	●	3.12	○		
36 x 25			2.27	●	2.27	○		
40 x 20			3.69	●	3.69	○		
40 x 30	+0.6	+2.0	-0.6	-2.0	2.40	●	2.40	○
45 x 25			4.32	●	4.32	○		
50 x 20			6.21	●	-	-		
50 x 25			5.64	○	-	-		
50 x 30			4.92	●	4.92	●		
50 x 40			3.09	●	3.09	○		
55 x 35			5.73	●	5.73	○		
60 x 30	+0.8	+2.5	-0.8	-2.5	8.16	●	-	-
60 x 40			6.36	●	6.36	○		
70 x 30			12.06	●	-	-		
70 x 40			10.14	●	-	-		
70 x 50			7.80	●	7.80	○		
75 x 30	+0.8	+3.0	-0.8	-3.0	14.07	○	-	-
80 x 40			14.34	●	-	-		
80 x 50			11.97	○	-	-		
80 x 60			9.09	●	9.09	○		
90 x 40			19.59	○	-	-		
90 x 60	+1.2	+3.6	-1.6	-5.0	14.52	○	-	-
100 x 50			22.65	○	-	-		
100 x 60			19.83	○	-	-		
Other standard lengths 1000 mm <sup>(3)</sup>								

Other measures available on request, subject to special conditions, also in ERTALON® 6 SA BLACK  
(1): tolerances according to DIN EN 15860,  
(2): average weights of production  
(3): tolerances in length -0 / + 3%

- Standard: generally available from stock
- Semi-standard: generally not available from stock
- Non-standard: generally not available from stock, manufactured to order and subject to special conditions

DIAM. (mm) Ø O.D. x Ø I.D.	ERTALON® 6 XAU+		ERTALON® LFX	
	KG/PIECE	STOCK	KG/PIECE	STOCK
Standard length 2000 mm				
60 x 30	5.54	○	5.47	●
60 x 40	4.36	●	4.31	○
70 x 30	8.01	●	7.91	●
70 x 40	6.84	●	6.75	●
70 x 50	5.30	○	5.24	●
80 x 30	10.80	○	10.65	○
80 x 40	9.64	●	9.51	●
80 x 50	8.10	○	6.12	●
80 x 60	6.20	○	6.12	●
90 x 50	11.70	○	11.55	●
90 x 70	7.66	○	7.56	○
100 x 50	15.65	○	15.45	○
100 x 60	13.80	○	13.60	○
100 x 80	9.01	○	8.90	○
110 x 50	19.25	○	19.00	●
110 x 70	15.20	○	15.00	○
115 x 100	9.13	●	9.01	○
120 x 80	17.20	○	17.00	○
125 x 100	14.15	○	14.15	●
130 x 60	27.40	●	27.05	○
140 x 110	17.60	○	17.35	○
150 x 70	36.60	●	36.10	○
150 x 120	20.30	○	20.05	○
160 x 100	16.55	○	16.35	○
160 x 120	12.80	○	12.60	○
200 x 160	17.15	○	16.90	○
260 x 235	19.15	○	18.90	○
270 x 215	19.35	○	19.10	○
Other standard lengths 600 mm				

Other orders available on request, subject to special conditions

**TOLERANCES:**  
 ØEXTERIOR até 60 mm: +3.0/+0.8 (Øext.); -0.8/-4.0\* (Øint.)  
 ØEXTERIOR 60-80 mm: +3.5/+0.8 (Øext.); -0.8/-4.0\* (Øint.)  
 ØEXTERIOR 80-110 mm: +4.5/+1.2 (Øext.); -1.8/-6.0\* (Øint.)  
 ØEXTERIOR 110-150 mm: +5.0/+1.5 (Øext.); -2.0/-7.5\* (Øint.)  
 ØEXTERIOR 150-180 mm: +7.5/+1.8 (Øext.); -2.2/-8.5\* (Øint.)  
 ØEXTERIOR 180-220 mm: +9.0/+2.0 (Øext.); -2.5/-9.5\* (Øint.)  
 ØEXTERIOR 220-250 mm: +10.0/+3.0 (Øext.); -3.0/-11.0\* (Øint.)  
 ØEXTERIOR 250-300 mm: +11.0/+3.0 (Øext.); -3.5/-13.0\* (Øint.)  
 ØEXTERIOR 300-400 mm: +13.0/+3.0 (Øext.); -3.5/-15.5\* (Øint.)  
 ØEXTERIOR 400-500 mm: +15.0/+3.0 (Øext.); -3.5/-18.0\* (Øint.)  
 ØEXTERIOR 500-600 mm: +20.0/+5.0 (Øext.); -4.5/-20.0\* (Øint.)





TUBES

DIAM. (mm)		ERTALON® 6 PLA		DIAM. (mm)		ERTALON® 6 PLA		DIAM. (mm)		ERTALON® 6 PLA	
Ø O.D..	x Ø I.D.	KG/PIECE <sup>(1)</sup>	NATURAL	Ø O.D..	x Ø I.D.	KG/PIECE <sup>(1)</sup>	NATURAL	Ø O.D..	x Ø I.D.	KG/PIECE <sup>(1)</sup>	NATURAL
Standard length 2000 mm			Standard length 1000 mm			Standard length 600 mm					
50 x 25	4.04	●	160 x 80	39.20	●	280 x 125	38.60	●			
56 x 25	5.10	●	160 x 100	33.10	●	280 x 200	25.95	●			
56 x 30	4.65	●	160 x 120	25.60	●	300 x 150	41.60	●			
56 x 35	4.11	●	170 x 135	25.30	●	300 x 200	32.45	●			
60 x 25	5.99	●	170 x 140	22.90	●	300 x 220	28.05	●			
60 x 30	5.54	●	180 x 80	26.20	●	325 x 250	29.95	●			
60 x 35	5.00	●	180 x 125	18.30	●	375 x 320	29.30	●			
60 x 40	4.36	●	180 x 150	12.35	●	425 x 300	59.70	●			
65 x 40	5.60	●	200 x 100	30.50	●	425 x 350	42.50	●			
65 x 50	4.06	●	200 x 110	28.75	●	450 x 400	34.75	●			
70 x 30	8.01	●	200 x 160	17.15	●	475 x 420	41.50	●			
70 x 40	6.84	●	210 x 100	34.45	●	500 x 430	50.00	●			
70 x 50	5.30	●	210 x 170	18.20	●	550 x 450	73.45	●			
75 x 30	9.36	●	220 x 100	39.20	●						
75 x 50	6.65	●	220 x 110	37.40	●						
75 x 60	4.75	●	220 x 120	35.45	●						
80 x 30	10.80	●	220 x 150	28.50	●						
80 x 40	9.64	●	220 x 180	19.90	●						
80 x 50	8.10	●	220 x 200	13.30	●						
80 x 60	6.20	●	225 x 150	30.85	●						
90 x 40	13.20	●	240 x 140	39.90	●						
90 x 50	11.70	●	250 x 100	53.42	●						
90 x 60	9.87	●	250 x 160	39.40	●						
90 x 70	7.66	●	250 x 175	35.05	●						
100 x 40	17.10	●	250 x 225	17.70	●						
100 x 50	15.65	●	250 x 200	26.95	●						
100 x 80	9.01	●									
110 x 70	15.20	●									
110 x 80	12.65	●									
110 x 90	9.73	●									
115 x 90	12.40	●									
120 x 50	23.75	●									
120 x 60	21.95	●									
120 x 65	20.90	●									
120 x 70	19.75	●									
120 x 80	17.20	●									
120 x 100	11.10	●									
125 x 100	14.15	●									
130 x 60	27.40	●									
130 x 80	22.70	●									
140 x 50	33.85	●									
140 x 70	29.90	●									
140 x 80	27.35	●									
140 x 100	21.20	●									
140 x 110	17.60	●									
140 x 120	13.60	●									
150 x 70	36.60	●									
150 x 80	34.05	●									
150 x 90	31.15	●									
150 x 100	27.90	●									
150 x 125	18.20	●									

(1): average production weights

- Standard: generally available from stock
- ◐ Semi-standard: generally not available from stock
- Non-standard: generally not available from stock, manufactured to order and subject to special conditions



**ROUND RODS**

DIAMETERS (mm)	TOLERANCES (mm) <sup>(1)</sup>		ERTALON® 6 PLA			ERTALON® 6 XAU+		ERTALON® LFX	
			KG/PIECE <sup>(2)</sup>	NATURAL	BLACK	KG/PIECE <sup>(1)</sup>	STOCK	KG/PIECE <sup>(1)</sup>	STOCK
Standard length 3000 mm <sup>(3)</sup>									
50	+0.5	+1.5	7.18	●	●	7.19	●	7.09	●
56			8.98	●	○	8.97	○	8.85	○
60	+0.5	+1.8	10.33	●	●	10.33	●	10.19	●
65			12.09	●	●	12.10	○	11.95	○
70	+0.7	+2.3	13.98	●	●	13.98	●	13.80	●
75			16.17	●	○	16.15	○	15.95	○
80	+1.0	+2.7	18.35	●	●	18.35	●	18.11	●
85			20.84	●	○	20.85	○	20.90	○
90	+1.0	+2.9	23.30	●	●	23.30	●	23.00	●
100			28.71	●	●	28.71	●	28.35	●
110	+1.1	+3.8	34.74	●	●	34.74	○	34.29	○
120			41.42	●	●	41.42	●	40.95	●
125	+1.2	+4.1	44.87	●	●	44.85	○	44.25	●
130			48.61	●	●	48.61	●	47.97	○
135	+1.3	+4.5	52.80	○	○	52.34	○	51.66	○
140			56.21	●	●	56.21	●	55.50	●
150			64.58	●	●	64.58	●	63.74	●
Standard length 1000 mm <sup>(3)</sup>									
160	+2.0	+7.0	24.90	●	●	24.90	●	24.60	●
170			28.05	●	○	28.05	○	27.65	○
180	+3.0	+9.0	31.35	●	●	31.35	○	30.95	○
190			34.85	●	○	34.85	●	34.40	○
200	+4.0	+11.0	38.50	●	●	38.50	○	38.00	●
210			42.95	●	●	42.95	○	42.40	○
220	+5.0	+13.0	47.05	●	○	47.05	○	46.40	○
225			49.15	○	○	49.15	○	48.50	○
230	+4.0	+11.0	51.30	●	○	51.30	○	50.60	○
240			55.70	●	○	55.70	○	55.00	○
250	+5.0	+13.0	60.35	●	○	60.35	○	59.55	○
260			65.15	●	○	65.15	○	64.30	○
270	+4.0	+11.0	70.15	○	○	70.15	○	69.25	○
275			72.70	●	○	72.70	○	71.75	○
280	+5.0	+13.0	75.30	●	○	75.30	○	74.35	○
290			80.65	○	○	80.65	○	79.60	○
300	+4.0	+11.0	86.20	●	○	86.20	○	85.10	○
325			101.80	●	○	101.80	○	100.50	○
350	+5.0	+13.0	117.70	●	○	117.70	○	116.10	○
375			134.70	●	○	134.70	○	133.00	○
400	+5.0	+13.0	152.90	●	○	152.90	○	150.90	○
425			173.40	●	○	173.40	○	171.20	○
450	+5.0	+13.0	194.00	●	○	194.00	○	191.50	○
475			215.70	○	○	215.70	○	212.90	○
500			238.50	●	○	238.50	○	235.40	○
Standard length 500 mm <sup>(3)</sup>									

Ertalon® 6 PLA blue available upon request and subject to special conditions  
 (1): tolerances according to DIN EN 15860  
 (2): average weights of production  
 (3): tolerances in length -0 /+ 3%

- Standard: generally available from stock
- Semi-standard: generally not available from stock
- Non-standard: generally not available from stock, manufactured to order and subject to special conditions



**ROUND RODS**

DIAMETER (mm)	TOLERANCES (mm) <sup>(1)</sup>		ERTALON® 6 SA			ERTALON® 66 SA			ERTALON® 4.6		ERTALON® 66 GF30	
			KG/PIECE <sup>(2)</sup>	NATURAL	BLACK	KG/PIECE <sup>(2)</sup>	NATURAL	BLACK	KG/PIECE <sup>(1)</sup>	STOCK	KG/PIECE <sup>(1)</sup>	STOCK
Standard length 3000 mm <sup>(3)</sup>												
5	+0.1	+0.4	0.08	●	○	0.08	○	○	-	-	-	-
6			0.11	●	○	0.11	○	○	-	-	-	-
8	+0.1	+0.5	0.19	●	○	0.19	○	○	-	-	-	-
10			0.29	●	●	0.29	●	○	-	-	0.33	●
12	+0.2	+0.7	0.42	●	●	0.42	●	○	-	-	0.49	○
14			0.57	○	○	0.57	○	○	-	-	-	-
15			0.65	●	○	0.65	●	○	-	-	0.75	●
16			0.74	●	●	0.74	●	○	0.77	○	0.85	●
18			0.93	●	○	0.93	●	○	0.97	○	1.07	○
20	+0.2	+0.9	1.14	●	●	1.14	●	●	1.19	●	1.31	●
22			1.39	●	○	1.39	○	○	1.44	○	1.59	○
25			1.79	●	●	1.79	●	○	1.85	●	2.04	●
28			2.22	●	○	2.22	○	○	2.31	○	2.55	○
30			2.55	●	●	2.55	●	○	2.64	●	2.91	●
32	+0.2	+1.1	2.91	●	●	2.91	●	○	3.03	○	3.33	○
36			3.66	●	●	3.66	●	○	3.81	○	4.20	●
40			4.50	●	●	4.50	●	●	4.71	●	5.16	●
45			5.73	●	●	5.73	●	○	5.97	○	6.54	○
50			7.05	●	●	7.05	●	○	7.35	●	8.04	●
56	+0.3	+1.3	8.79	●	●	8.79	●	○	-	-	-	-
60			10.14	●	●	10.14	●	○	10.56	●	11.58	●
65			11.85	●	○	11.85	○	○	-	-	-	-
70			13.71	●	●	13.71	●	○	-	-	15.66	●
75			15.84	●	○	15.84	●	○	-	-	-	-
80	+0.4	+2.0	17.97	●	●	17.97	●	○	-	-	20.52	●
85			20.34	○	○	20.34	○	○	-	-	-	-
90	+0.5	+2.2	22.74	●	●	22.74	●	○	-	-	25.98	○
95			25.41	○	○	25.41	○	○	-	-	-	-
100	+0.6	+2.5	28.11	●	●	28.11	●	○	-	-	32.10	●
105			31.20	○	○	-	-	-	-	-	-	-
110	+0.7	+3.0	34.05	●	○	34.05	●	-	-	-	39.00	○
115			37.35	○	○	-	-	-	-	-	-	-
120	+0.8	+3.5	40.65	●	●	40.65	●	-	-	-	46.50	●
125			44.10	●	○	44.10	○	-	-	-	50.40	○
130	+0.9	+3.8	47.70	●	○	47.70	○	-	-	-	54.60	○
140			55.20	●	○	55.20	○	-	-	-	63.15	●
150	+1.0	+4.2	63.45	●	●	63.45	○	-	-	-	72.60	○
160			72.30	●	○	72.30	○	-	-	-	-	-
170	+1.2	+5.0	81.75	●	○	81.75	○	-	-	-	-	-
180			91.35	●	○	91.35	○	-	-	-	104.55	○
190	+1.3	+5.5	102.00	○	○	102.00	○	-	-	-	-	-
200			112.80	●	●	112.80	○	-	-	-	128.85	○
220	+1.3	+5.8	136.20	●	○	136.20	○	-	-	-	-	-
250			175.65	●	○	175.65	○	-	-	-	-	-
280	+1.6	+6.5	219.90	○	○	-	-	-	-	-	-	-
300			252.60	●	○	-	-	-	-	-	-	-
320	+1.8	+7.4	287.25	●	○	-	-	-	-	-	-	-
Standard length 1000 mm <sup>(3)</sup>												

(1): tolerances according to DIN EN 15860  
 (2): average weights of production  
 (3): tolerances in length -0 / + 3%

● Standard; generally available from stock  
 ○ Semi-standard; generally not available from stock  
 ○ Non-standard; generally not available from stock, manufactured to order and subject to special conditions



PA ●

# NYLATRON® GS

**Semi-crystalline plastic**, with addition of MoS<sub>2</sub> (Molybdenum Disulphide), which gives this material greater stiffness, hardness and dimensional stability than ERTALON® 66 SA, although slightly reducing the impact resistance. The dispersion of Molybdenum Disulphide in the molecular structure results in a higher degree of crystallization, improving the sliding and wear properties.

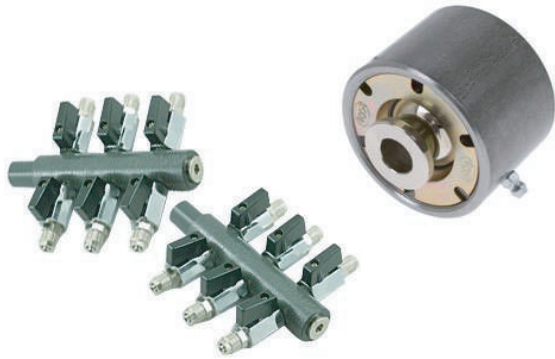
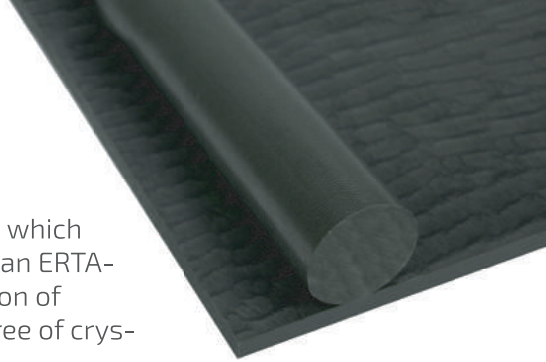

## MAIN CHARACTERISTICS

- Higher stiffness, hardness and dimensional stability
- Higher degree of crystallization
- Better sliding properties and wear resistance
- Low coefficient of friction
- Complementary to Nylatron® GSM, on availability
- Good electrical insulation properties
- Good resistance to high energy radiation (gamma rays and X-rays)
- High mechanical damping capacity
- Easy machining
- Self-lubricating material

## APPLICATIONS

- Bushings with high rotation, subjected to loads
- Sliding rulers
- All applications of polyamides where higher wear resistance and sliding power are required



CHEMICAL RESISTANCE



ELECTRICAL INSULATION



WEAR RESISTANCE



SLIDING PROPERTIES



IMPACT RESISTANCE

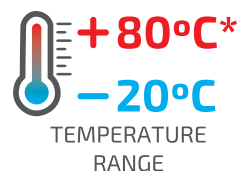

\*continuously (20.000H)



**Semi-crystalline plastic**, NYLATRON® GSM contains fine MoS<sub>2</sub> particles homogeneously dispersed to improve sliding properties without losing impact and fatigue resistance, characteristics of additive-free polyamides. It is characterized by a high concentration of MoS<sub>2</sub>, making it a "Premium" material in demanding applications.

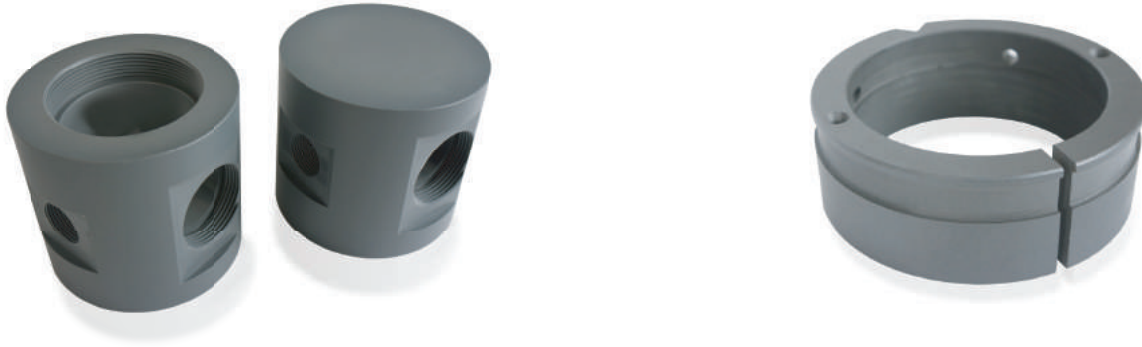

## MAIN CHARACTERISTICS

- ◆ High mechanical resistance
- ◆ High rigidity and hardness
- ◆ Self-lubricating material
- ◆ High resistance to wear without reducing resistance to impact and fatigue
- ◆ Good resistance to high energy radiation (gamma rays and X-rays)
- ◆ Good sliding properties
- ◆ Good electrical insulation properties
- ◆ High mechanical damping capacity
- ◆ Easy machining

## APPLICATIONS

- ◆ Bushings with rotation, subjected to heavy loads
- ◆ Steel Cable Pulleys
- ◆ Sprockets
- ◆ Gears

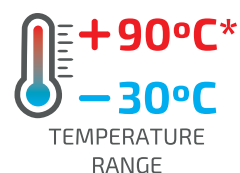
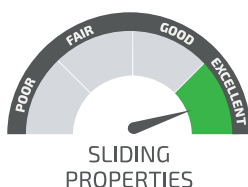
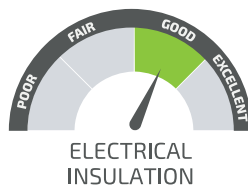

\*continuously (20.000H)



PA ●

# NYLATRON® NSM

**Semi-crystalline plastic,** NYLATRON® NSM is a self-formulated cast polyamide 6 containing solid lubricants in the form of additives which give this material self-lubricating properties, excellent sliding properties, wear resistance and pressure-speed factor limits (about 5 times higher than conventional cast polyamides). It perfectly complements ERTALON® LFX, since it is a material especially recommended for lubrication-free applications that require high sliding speeds.

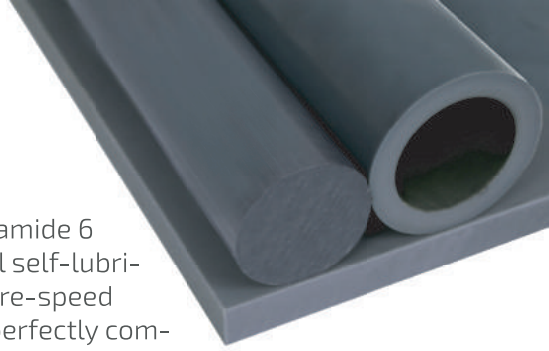

ERTALON®  
NYLATRON®



## MAIN CHARACTERISTICS

- Excellent sliding properties
- Low coefficients of friction
- Self-lubricating
- High resistance to wear
- Pressure-velocity values up to 5 times higher than conventional polyamides
- Good resistance to high energy radiation (gamma rays and X-rays)
- Good electrical insulation properties
- High mechanical damping capacity
- Easy machining

## APPLICATIONS

- Bushings with rotation, subjected to heavy loads
- Sliding guides
- Large parts
- Especially recommended for non-lubricated applications with high sliding speeds
- Bearings
- Rollers, wheels, wear components
- Wear pads
- Gears



CHEMICAL RESISTANCE



ELECTRICAL INSULATION



WEAR RESISTANCE



SLIDING PROPERTIES



IMPACT RESISTANCE

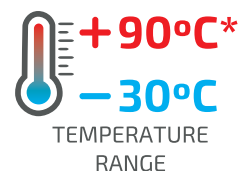

\*continuously (20.000H)

# NYLATRON® MC 901

**Semi-crystalline plastic**, NYLATRON® MC 901 is a cast and modified polyamide. It distinguishes itself by its characteristic blue colour and exhibits greater toughness, flexibility and fatigue resistance than the ERTALON® 6 PLA.



## MAIN CHARACTERISTICS

- ◆ High resistance to impact
- ◆ High elasticity/flexibility
- ◆ High fatigue resistance
- ◆ High toughness
- ◆ Excellent wear resistance
- ◆ Good sliding properties
- ◆ Good electrical insulation properties
- ◆ Good resistance to high energy radiation (gamma rays and X-rays)
- ◆ High mechanical damping capacity
- ◆ Easy machining

## APPLICATIONS

- ◆ Automatic lathes machining
- ◆ High module sprockets
- ◆ Wheels and rollers
- ◆ Bushings
- ◆ Separators
- ◆ Large parts subjected to heavy loads



CHEMICAL  
RESISTANCE



ELECTRICAL  
INSULATION



WEAR  
RESISTANCE



SLIDING  
PROPERTIES



IMPACT  
AO RESISTANCE

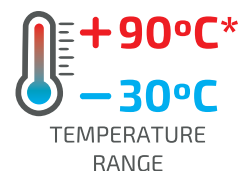

\*continuously (20.000H)



PA ○ ●

# NYLATRON® SLG

**Semi-crystalline plastic**, NYLATRON® SLG (Self Lubricated Grade), is a self-lubricated polyamide. It has been specially developed for non-lubricated applications whose parts are subjected to high loads and low speeds. Compared with other cast polyamides, it offers more life time, lowering maintenance costs.

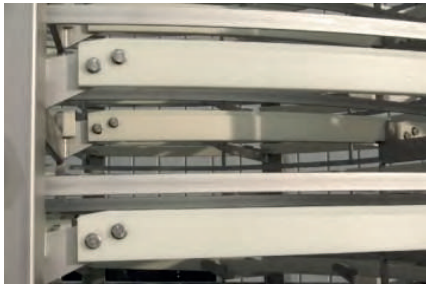

ERTALON®  
NYLATRON®

## MAIN CHARACTERISTICS

- ◆ Self-lubricating
- ◆ High mechanical resistance, stiffness and hardness
- ◆ Good resistance to fatigue
- ◆ High mechanical damping capacity
- ◆ Good sliding properties
- ◆ Excellent resistance to wear
- ◆ Good electrical insulation

## APPLICATIONS

- ◆ Sliding rulers
- ◆ In general, all static or dynamic applications requiring lubrication exemption and are subjected to heavy loads and low speeds

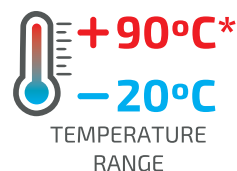
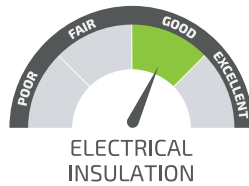
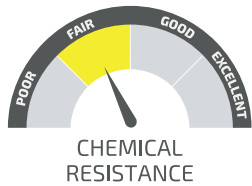

\*continuously (20.000H)

# NYLATRON® 703 XL



**Semi-crystalline plastic**, NYLATRON® 703 XL is a unique polyamide, developed to expand the performance limits of engineering plastics used in machined parts. It is also the only nylon with zero stick-slip, a property that allows greater sensitivity and precision of movements, being especially recommended for applications with no lubrication with high sliding speeds. These extreme performance levels improve productivity, efficiency, quality and the lifetime of the equipment.

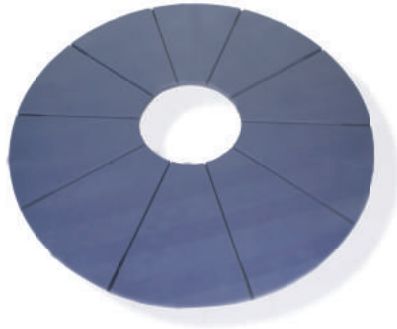

## MAIN CHARACTERISTICS

- ◆ Higher wear resistance than any other conventional nylon
- ◆ Reduction or even elimination of lubrication
- ◆ Upper limit of PV values (pressure/velocity)
- ◆ Increased overall system energy efficiency
- ◆ Near-zero stick-slip effect, allowing for extraordinary motion control in high-precision applications
- ◆ High mechanical damping capacity
- ◆ Self-lubricating material

## APPLICATIONS

- ◆ Hoist coating
- ◆ Telescopic Cranes
- ◆ Sliding systems in concrete and/or steel constructions
- ◆ Slip systems in pneumatic or electric controls
- ◆ Wear pads



CHEMICAL RESISTANCE



ELECTRICAL INSULATION



WEAR RESISTANCE



SLIDING PROPERTIES



IMPACT AO RESISTANCE

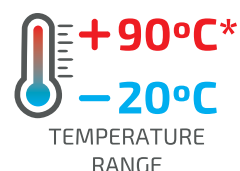

\*continuously (20.000H)



**TUBES**

DIAM. (mm) Ø O.D. x Ø I.D.	NYLATRON® GSM		NYLATRON® NSM		NYLATRON® MC 901	
	KG/PIECE <sup>(1)</sup>	STOCK	KG/PIECE <sup>(1)</sup>	STOCK	KG/PIECE <sup>(1)</sup>	STOCK
Standard length 1000 mm						
50 x 20	2.21	●	-	-	4.40	-
50 x 25	2.03	●	1.99	●	-	-
56 x 25	2.51	●	-	-	-	-
56 x 35	-	-	2.03	●	-	-
60 x 30	2.73	●	2.73	●	-	-
60 x 40	2.15	●	-	-	-	-
65 x 40	-	-	2.76	●	-	-
70 x 30	-	-	3.95	●	8.00	●
70 x 50	-	-	2.61	●	-	-
75 x 60	2.34	●	-	-	-	-
80 x 40	4.75	●	4.75	●	-	-
80 x 60	3.06	●	-	-	-	-
90 x 50	5.77	●	-	-	-	-
90 x 60	4.87	●	4.87	●	-	-
100 x 40	8.45	●	8.45	●	-	-
100 x 50	-	-	-	-	15.64	●
100 x 60	6.80	●	-	-	-	-
100 x 80	4.52	●	4.44	●	9.00	●
110 x 50	-	-	9.50	●	-	-
110 x 80	-	-	6.25	●	12.64	●
120 x 70	-	-	-	-	19.74	●
120 x 80	8.60	●	-	-	17.20	●
120 x 100	5.47	●	-	-	-	-
125 x 60	12.57	●	12.35	●	-	-
125 x 80	-	-	10.02	●	-	-
125 x 100	6.97	●	6.97	●	-	-
130 x 100	8.17	●	-	-	-	-
140 x 60	16.10	●	-	-	-	-
140 x 70	-	-	14.75	●	-	-
140 x 100	10.65	●	-	-	-	-
150 x 80	17.10	●	-	-	-	-
140 x 110	-	-	-	-	17.60	●
150 x 120	10.20	●	-	-	-	-
150 x 130	8.02	●	-	-	-	-
160 x 100	16.67	●	-	-	-	-
160 x 130	10.70	●	-	-	-	-
170 x 140	11.52	●	-	-	-	-
180 x 160	9.72	●	-	-	-	-
200 x 140	22.40	●	-	-	-	-
200 x 180	11.30	●	-	-	1000 mm	-
220 x 100	-	-	-	-	39.20	●
250 x 175	35.20	●	-	-	-	-
Standard length 600 mm*						
250 x 80	-	-	-	-	56.41	●
300 x 90	-	-	-	-	81.58	●
300 x 200	54.08	●	-	-	-	-
325 x 90	-	-	-	-	96.75	●
350 x 90	-	-	-	-	112.91	●
350 x 100	111.34	●	-	-	-	-
350 x 200	86.75	●	-	-	-	-
375 x 320	48.80	●	-	-	-	-
400 x 360	43.08	●	-	-	-	-

Average weights of production.  
\* Weight per meter.

- Standard: generally available from stock
- ◐ Semi-standard: generally not available from stock
- Non-standard: generally not available from stock, manufactured to order and subject to special conditions

**PLATES**

THICKNESS (mm)	TOLERANCES (mm) <sup>(1)</sup>		NYLATRON® GS	
	KG/PIECE <sup>(2)</sup>	STOCK	KG/PIECE <sup>(2)</sup>	STOCK
Standard size 610 x 3000 mm <sup>(3)</sup>				
8			18.78	○
10	+0.2	+0.9	23.19	●
12			28.32	●
16			37.20	◐
20	+0.3	+1.5	46.05	◐
25			57.00	○
Other standard sizes 610 x 1000 mm <sup>(3)</sup>				

Other thickness available on request.  
(1): tolerances according to DIN EN 15860  
(2): average weights of production  
(3): tolerances in width + 5 / + 25mm; in length -0 / + 3%

**PLATES**

THICKNESS (mm)	TOLERANCES (mm)		NYLATRON® 703 XL	
	KG/PIECE <sup>(1)</sup>	STOCK	KG/PIECE <sup>(1)</sup>	STOCK
Standard size 1220 x 3050 mm				
10			41.30	●
16			66.10	●
20	+0.5	+2.5	82.60	●
30			123.90	●
35			159.97	●
40			176.80	●
50			224.94	●
60	+0.5	+3.0	263.90	○
80			348.40	◐

TOLERANCES (WIDTH x LENGTH MM):  
610 (0/+10) x 1200 (+10/+20) mm  
1220 (+10/+20) x 2000 (+10/+30) mm  
1220 (+10/+20) x 3050 (+20/+40) mm

(1): average production weights  
Other measures available on request: 610x1220  
1220x2000  
1000x1220

**ROUND RODS**

THICKNESS (mm)	TOLERANCES (mm) <sup>(1)</sup>		NYLATRON® GS	
	KG/PIECE <sup>(2)</sup>	STOCK	KG/PIECE <sup>(2)</sup>	STOCK
Standard length 3000 mm <sup>(3)</sup>				
6	+0.1	+0.4	0.11	●
8			0.19	○
10	+0.1	+0.5	0.29	○
12			0.43	●
15			0.66	○
16	+0.2	+0.7	0.75	●
18			0.95	●
20			1.16	●
22			1.41	○
25			1.82	●
28	+0.2	+0.9	2.27	○
30			2.58	●
32			2.96	●
35	+0.2	+1.1	3.51	●
40			4.56	●
45	+0.3	+1.3	5.82	●
50			7.14	●
Standard length 1000 mm <sup>(3)</sup>				

(1): tolerances according to DIN EN 15860  
(2): average weights of production  
(3): tolerances in length -0 / + 3%

## PLATES

THICKNESS (mm)	TOLERANCES (mm)		NYLATRON® MC 901		NYLATRON® GSM		NYLATRON® NSM	
			KG/PIECE <sup>(1)</sup>	STOCK	KG/PIECE <sup>(1)</sup>	STOCK	KG/PIECE <sup>(1)</sup>	STOCK
Standard size 1220 x 2000 mm								
10	+0.5	+2.5	33.15	●	33.30	●	32.70	●
12			38.90	○	39.05	●	38.40	●
16			50.40	○	50.65	●	49.75	●
20			61.95	●	62.20	●	61.15	●
25			76.35	○	76.70	●	75.35	●
30	+0.5	+3.0	91.85	●	92.25	●	90.65	●
35			106.30	●	106.70	●	104.90	○
40			120.70	●	121.20	●	119.10	●
45			135.10	○	135.60	○	133.30	○
50			149.50	●	150.10	●	147.50	○
55	+0.5	+3.5	165.70	○	166.40	○	163.50	○
60			180.10	○	180.90	●	177.70	○
65			194.50	●	195.30	○	192.00	○
70	+0.5	+4.5	208.90	○	209.80	○	206.20	○
75			223.30	●	224.30	○	220.40	○
80			237.70	○	238.70	●	234.60	○
90			266.50	●	267.70	○	263.10	○
100			295.30	●	296.60	○	291.50	○

(1): average production weights

TOLERANCES (WIDTH x LENGTH MM):  
1220 (+10/+20) x 2000 (+10/+30) mm

## ROUND RODS

DIAMETER (mm)	TOLERANCES (mm) <sup>(1)</sup>		NYLATRON® MC 901		NYLATRON® GSM		NYLATRON® NSM	
			KG/PIECE <sup>(2)</sup>	STOCK	KG/PIECE <sup>(2)</sup>	STOCK	KG/PIECE <sup>(2)</sup>	STOCK
Standard length 3000 mm <sup>(3)</sup>								
50	+0.5	+1.5	7.19	●	7.21	●	7.08	●
56			8.97	●	9.01	●	8.85	●
60	+0.5	+1.8	10.33	●	10.37	●	10.29	●
65			12.10	●	12.14	●	11.95	○
70			14.00	●	14.04	●	13.80	●
75	+0.7	+2.3	16.15	●	16.24	●	15.95	●
80			18.35	●	18.43	●	18.10	●
85	+1.0	+2.7	20.85	○	20.93	●	20.55	○
90			23.30	○	23.40	●	23.00	●
100	+1.0	+2.9	28.71	●	28.84	●	28.35	●
110	+1.0	+3.3	34.80	●	34.89	●	34.35	●
120	+1.1	+3.8	41.40	○	41.55	●	40.95	○
125			44.85	●	45.00	●	44.25	○
130	+1.2	+4.1	48.60	●	48.82	●	48.00	○
135			52.34	○	52.57	○	51.95	○
140			56.25	○	56.45	●	55.50	○
150	+1.3	+4.5	64.65	●	64.86	●	63.75	○
Standard length 1000 mm <sup>(3)</sup>								
160	+2.0	+7.0	24.90	●	25.00	●	24.60	○
180			31.35	●	31.50	●	30.95	○
200			38.50	●	38.65	●	38.00	○
250	+3.0	+9.0	60.35	●	60.60	●	59.55	○
300			86.20	●	86.60	●	85.10	○
325	+4.0	+11.0	101.80	●	102.20	●	100.50	○
450	+5.0	+13.0	194.00	●	194.80	●	191.50	○
500			238.50	●	239.60	○	235.40	○

(1): tolerances according to DIN EN 15860

(2): average weights of production

(3): tolerances in length -0 / + 3%

- Standard: generally available from stock
- Semi-standard: generally not available from stock
- Non-standard: generally not available from stock, manufactured to order and subject to special conditions



# PA TECHNICAL DATASHEET

PROPERTIES	TEST METHODS	UNITS	ERTALON® 6 SA	ERTALON® 66 SA	ERTALON® 4.6	ERTALON® 66 GF30	ERTALON® 6 PLA	ERTALON® 6 XAU+
COLOR		-	WHITE/BLACK	WHITE/BLACK	REDDISH BROWN	BLACK	WHITE/BLACK	BLACK
DENSITY	ISO 1183-1	g/cm <sup>3</sup>	1.14	1.14	1.19	1.29	1.15	1.15
WATER ABSORPTION								
AFTER 24/96H IMMERSION IN WATER OF 23°C <sup>1</sup>	ISO 62	mg	86/168	40/76	90/180	30/56	44/83	47/89
AFTER 24/96H IMMERSION IN WATER OF 23°C <sup>1</sup>	ISO 62	%	1.28/2.50	0.60/1.13	1.30/2.60	0.39/0.74	0.65/1.22	0.69/1.31
AT SATURATION IN AIR OF 23°C / 50% RH	-	%	2.6	2.4	2.8	1.7	2.2	2.2
AT SATURATION IN WATER OF A 23°C	-	%	9	8	9.5	5.5	6.5	6.5
<b>THERMAL PROPERTIES<sup>2</sup></b>								
MELTING TEMPERARUTE (DSC, 10°C/MIN)	ISO 11357-1/-3	°C	220	260	290	260	215	215
GLASS TRANSITION TEMPERATURE (DSC, 20°C/MIN) <sup>3</sup>	ISO 11357-1/-3	°C	-	-	-	-	-	-
THERMAL CONDUCTIVITY A 23°C	-	W/(K.m)	0.28	0.28	0.30	0.30	0.29	0.29
COEFFICIENT OF LINEAR THERMAL EXPANSION								
AVERAGE VALUE BETWEEN 23-60°C	-	M/(m.K)	90 x 10 <sup>-6</sup>	80 x 10 <sup>-6</sup>	80 x 10 <sup>-6</sup>	50 x 10 <sup>-6</sup>	80 x 10 <sup>-6</sup>	80 x 10 <sup>-6</sup>
AVERAGE VALUE BETWEEN 23-100°C	-	M/(m.K)	105 x 10 <sup>-6</sup>	95 x 10 <sup>-6</sup>	90 x 10 <sup>-6</sup>	60 x 10 <sup>-6</sup>	90 x 10 <sup>-6</sup>	90 x 10 <sup>-6</sup>
TEMPERATURE OF DEFLECTION UNDER LOAD								
METHOD A 1.8 MPA	+ ISO 75-1/-2	°C	70	85	160	150	80	80
MAXIMUM ALLOABLE SERVICE TEMPERATURE IN AIR								
FOR SHORT PERIODS <sup>4</sup>	-	°C	160	180	200	200	170	180
CONTINUOUSLY: FOR 5.000/20.000H <sup>5</sup>	-	°C	85/70	95/80	150/130	120/110	105/90	120/105
MINIMUM SERVICE TEMPERATURE <sup>6</sup>	-	°C	-40	-30	-40	-20	-30	-30
FAMMABILITY <sup>7</sup>								
"OXYGEN INDEX"	ISO 4589-1/-2	%	25	26	24	-	25	25
ACCORDING TO UL94 (3/6MM DE ESPESSURA)	-	-	HB/HB	HB/HB	HB/HB	HB/HB	HB/HB	HB/HB
<b>MECHANICAL PROPERTIES AT 23°C<sup>8</sup></b>								
TENSION TEST <sup>9</sup>								
TENSILE STRESS AT YIELD/AT BREAK <sup>10</sup>	+ ISO 527-1/-2	MPa	80/-	90/-	105/-	NA/85	86/-	84/-
TENSILE STRESS AT YIELD/AT BREAK <sup>10</sup>	++ ISO 527-1/-2	MPa	45/-	55/-	55/-	-	55/-	55/-
TENSILE STRENGTH <sup>10</sup>	+ ISO 527-1/-2	MPa	80	93	105	85	88	86
TENSILE STRAIN AT YIELD <sup>10</sup>	+ ISO 527-1/-2	%	4	5	18	NA	5	5
TENSILE STRAIN AT BREAK <sup>10</sup>	+ ISO 527-1/-2	%	>50	50	25	5	25	25
TENSILE STRAIN AT BREAK <sup>10</sup>	++ ISO 527-1/-2	%	>100	>100	>50	-	>50	>50
TENSILE MODULUS OF ELASTICITY <sup>11</sup>	+ ISO 527-1/-2	MPa	3300	3550	3400	5000	3600	3500
TENSILE MODULUS OF ELASTICITY <sup>11</sup>	++ ISO 527-1/-2	MPa	1425	1700	1350	2700	1750	1700
COMPRESSION TEST <sup>12</sup>								
COMPRESSIVE STRESS AT 1/2/5% NOMINAL STRAIN <sup>11</sup>	+ ISO 604	MPa	31/59/87	32/62/100	31/60/102	43/77/112	34/64/93	34/64/93
CHARPY IMPACT STRENGTH - UNNOTCHED <sup>13</sup>	+ ISO 179-1/1eU	KJ/m <sup>2</sup>	NO BREAK	NO BREAK	NO BREAK	50	NO BREAK	NO BREAK
CHARPY IMPACT STRENGTH - NOTCHED	+ ISO 179-1/1eA	KJ/m <sup>2</sup>	5.5	4.5	8	6	3	3
BALL IDENTATION HARDNESS <sup>4</sup>	+ ISO 2039-1	N/mm <sup>2</sup>	150	160	165	165	165	165
ROCKWELL HARDNESS <sup>14</sup>	+ ISO 2039-2	-	M 85	M 88	M 92	M 76	M 88	M 87
<b>ELECTRICAL PROPERTIES AT 23°C</b>								
ELECTRIC STRENGTH <sup>15</sup>	+ IEC 60243-1	kV/mm	25	27	25	27	25	29
ELECTRIC STRENGTH <sup>15</sup>	++ IEC 60243-1	kV/mm	16	18	15	18	17	19
VOLUME RESISTIVITY	+ IEC 60093	Ohm.cm	> 10 <sup>14</sup>	> 10 <sup>14</sup>	> 10 <sup>14</sup>	> 10 <sup>14</sup>	> 10 <sup>14</sup>	> 10 <sup>14</sup>
VOLUME RESISTIVITY	++ IEC 60093	Ohm.cm	> 10 <sup>12</sup>	> 10 <sup>12</sup>	> 10 <sup>12</sup>	> 10 <sup>12</sup>	> 10 <sup>12</sup>	> 10 <sup>12</sup>
SURFACE RESISTIVITY	+ IEC 60093	Ohm	> 10 <sup>13</sup>	> 10 <sup>13</sup>	> 10 <sup>13</sup>	> 10 <sup>13</sup>	> 10 <sup>13</sup>	> 10 <sup>13</sup>
SURFACE RESISTIVITY	++ IEC 60093	Ohm	> 10 <sup>12</sup>	> 10 <sup>12</sup>	> 10 <sup>12</sup>	> 10 <sup>12</sup>	> 10 <sup>12</sup>	> 10 <sup>12</sup>
RELATIVE PERMITTIVITY ε <sub>r</sub> : A 100HZ	+ IEC 60250	-	3.9	3.8	3.8	3.9	3.6	3.6
RELATIVE PERMITTIVITY ε <sub>r</sub> : A 100HZ	++ IEC 60250	-	7.4	7.4	7.4	6.9	6.6	6.6
RELATIVE PERMITTIVITY ε <sub>r</sub> : A 1MHZ	+ IEC 60250	-	3.3	3.3	3.4	3.6	3.2	3.2
RELATIVE PERMITTIVITY ε <sub>r</sub> : A 1MHZ	++ IEC 60250	-	3.8	3.8	3.8	3.9	3.7	3.7
DIELECTRIC DISSIPATION FACTOR TAN δ : A 100HZ	+ IEC 60250	-	0.019	0.013	0.009	0.012	0.012	0.015
DIELECTRIC DISSIPATION FACTOR TAN δ : A 100HZ	++ IEC 60250	-	0.13	0.13	0.13	0.19	0.14	0.15
DIELECTRIC DISSIPATION FACTOR TAN δ : A 1MHZ	+ IEC 60250	-	0.021	0.020	0.019	0.014	0.016	0.017
DIELECTRIC DISSIPATION FACTOR TAN δ : A 1MHZ	++ IEC 60250	-	0.06	0.06	0.06	0.04	0.05	0.05
COMPARATIVE TRACKING INDEX (CTI)	+ IEC 60112	-	600	600	400	475	600	600
COMPARATIVE TRACKING INDEX (CTI)	++ IEC 60112	-	600	600	400	475	600	600

NOTE: 1 g/cm<sup>3</sup> = 1000 kg/m<sup>3</sup> ; 1 MPa = 1 N/mm<sup>2</sup> ; 1 KV/mm = 1 MV/m

+: values for dry material

++: values referring to material in equilibrium with the standard atmosphere 23°C / 50% rh

PA  
**TECHNICAL DATASHEET**



ERTALON®  
NYLATRON®

ERTALON® LFX	NYLATRON® GS	NYLATRON® GSM	NYLATRON® NSM	NYLATRON® MC 901	NYLATRON® SLG	NYLATRON® 703 XL
GREEN	GREY-BLACK	GREY-BLACK	GREY	BLUE	WHITE/BLUE	PURPLE
1.135	1.15	1.16	1.14	1.15	1.135	1.11
44/83	46/85	52/98	40/76	49/93	44/83	40/76
0.66/1.24	0.68/1.25	0.76/1.43	0.59/1.12	0.72/1.37	0.66/1.24	0.61/1.16
2	2.3	2.4	2	2.3	2	2
6.3	7.8	6.7	6.3	6.6	6.3	6.3
215	260	215	215	215	215	215
-	-	-	-	-	-	-
0.28	0.29	0.30	0.29	0.29	0.28	0.30
80 x 10 <sup>-6</sup>	80 x 10 <sup>-6</sup>	80 x 10 <sup>-6</sup>	80 x 10 <sup>-6</sup>	80 x 10 <sup>-6</sup>	80 x 10 <sup>-6</sup>	85 x 10 <sup>-6</sup>
90 x 10 <sup>-6</sup>	90 x 10 <sup>-6</sup>	90 x 10 <sup>-6</sup>	95 x 10 <sup>-6</sup>	90 x 10 <sup>-6</sup>	90 x 10 <sup>-6</sup>	100 x 10 <sup>-6</sup>
75	85	80	75	80	75	70
165	180	170	165	170	165	160
105/90	95/80	105/90	105/90	105/90	105/90	105/90
-20	-20	-30	-30	-30	-20	-20
-	26	25	-	25	-	<20
HB/HB	HB/HB	HB/HB	HB/HB	HB/HB	HB/HB	HB/HB
72/-	93/-	80/-	78/-	82/-	72/-	60/-
45/-	55/-	50/-	50/-	50/-	45/-	40/-
73	95	82	80	84	73	60
5	5	5	5	5	5	6
25	20	25	25	35	25	15
>50	>50	>50	>50	>50	>50	>25
3000	3600	3400	3150	3300	3000	2750
1450	1725	1650	1525	1600	1450	1350
31/58/85	32/62/100	33/62/91	31/59/87	32/61/90	31/58/85	26/48/69
50	NO BREAK	NO BREAK	75	NO BREAK	50	25
4	4	3	3.5	3	4	4
145	165	160	150	160	145	120
M 82	M 88	M 84	M 81	M 85	M 82	R 109 (M 59)
22	26	24	25	25	22	-
14	17	16	17	17	14	-
> 10 <sup>14</sup>	> 10 <sup>14</sup>	> 10 <sup>14</sup>	> 10 <sup>14</sup>	> 10 <sup>14</sup>	> 10 <sup>14</sup>	> 10 <sup>14</sup>
> 10 <sup>12</sup>	> 10 <sup>12</sup>	> 10 <sup>12</sup>	> 10 <sup>12</sup>	> 10 <sup>12</sup>	> 10 <sup>12</sup>	> 10 <sup>12</sup>
> 10 <sup>13</sup>	> 10 <sup>13</sup>	> 10 <sup>13</sup>	> 10 <sup>13</sup>	> 10 <sup>13</sup>	> 10 <sup>13</sup>	> 10 <sup>13</sup>
> 10 <sup>12</sup>	> 10 <sup>12</sup>	> 10 <sup>12</sup>	> 10 <sup>12</sup>	> 10 <sup>12</sup>	> 10 <sup>12</sup>	> 10 <sup>12</sup>
3.5	3.8	3.6	3.6	3.6	3.5	-
6.5	7.4	6.6	6.6	6.6	6.5	-
3.1	3.3	3.2	3.2	3.2	3.1	-
3.6	3.8	3.7	3.7	3.7	3.6	-
0.015	0.013	0.012	0.012	0.012	0.015	-
0.15	0.13	0.14	0.14	0.14	0.15	-
0.016	0.020	0.016	0.016	0.016	0.016	-
0.05	0.06	0.05	0.05	0.05	0.05	-
600	600	600	600	600	600	-
600	600	600	600	600	600	-

(1) According to method 1 of ISO 62 and measured on ø 50x3 mm discs. (2) The elements supplied for this property are for the most part supplied by the manufacturers of the raw materials. (3) The values of this property are only attributed to amorphous rather than semi-crystalline materials. (4) Only for short periods of exposure in applications where only very low loads are applied to the material. (5) Temperature that resists after a period of 5,000 / 20,000 hours. After this time, there is a decrease of about 50% in tensile strength compared to the original value. The given temperature values are based on the thermal oxidation degradation which occurs which causes a reduction of the properties. In the meantime, the maximum permissible service temperature depends in many cases essentially on the deduction and magnitude of the mechanical stresses to which the material is subject. (6) As the impact strength decreases with decreasing temperature, the minimum allowable service temperature is determined by the extent of impact to which the material is subjected. The values given are based on unfavorable impact conditions and can not therefore be considered absolute limits. (7) These assessments derive from the technical specifications of the manufacturers of the raw materials and do not allow the determination of the behavior of the materials under fire conditions. (8) Most of the figures given by the properties of the (+) materials are mean values of the tests done on species machined with ø 40-60 mm. (9) Specimen testing: Type 1b. (10) Speed test: 5 or 50 mm / min. (11) Speed test: 1m / min. (12) Testing specimens: cylinders ø 8 x 16 mm. (13) Pendulum used: 15J. (14) Test on 10 mm thick specimens. (15) Electrode configuration: cylinders ø 25 / ø 75 mm, in transformer oil according to IEC 60296.

Note that the electrical force for the extruded black material can be considerably lower than that of natural material. The possible micro porosity in the center of conserved forms in stock significantly reduces the electric force.



# MAXIMUM ALLOWABLE SERVICE TEMPERATURE IN AIR

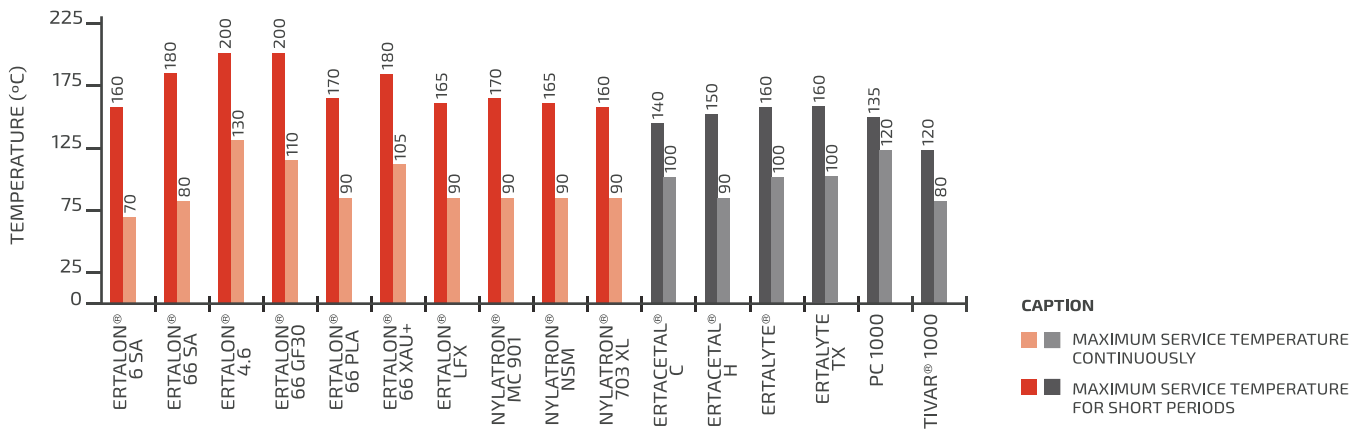

**CAPTION**

- Orange bar: MAXIMUM SERVICE TEMPERATURE CONTINUOUSLY
- Grey bar: MAXIMUM SERVICE TEMPERATURE FOR SHORT PERIODS

ERTALON®  
NYLATRON®

# RIGIDITY vs. TEMPERATURE

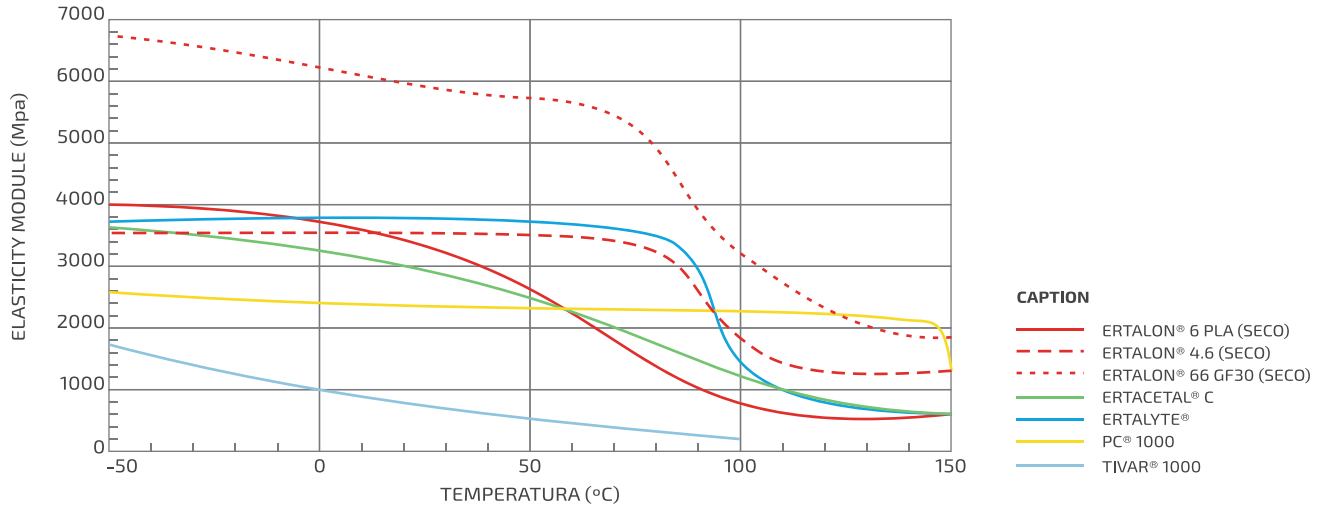

**CAPTION**

- Red solid line: ERTALON® 6 PLA (SECO)
- Red dashed line: ERTALON® 4.6 (SECO)
- Red dotted line: ERTALON® 66 GF30 (SECO)
- Green solid line: ERTACETAL® C
- Blue solid line: ERTALYTE®
- Yellow solid line: PC® 1000
- Light blue solid line: TIVAR® 1000

# CHEMICAL RESISTANCE AT 23°C

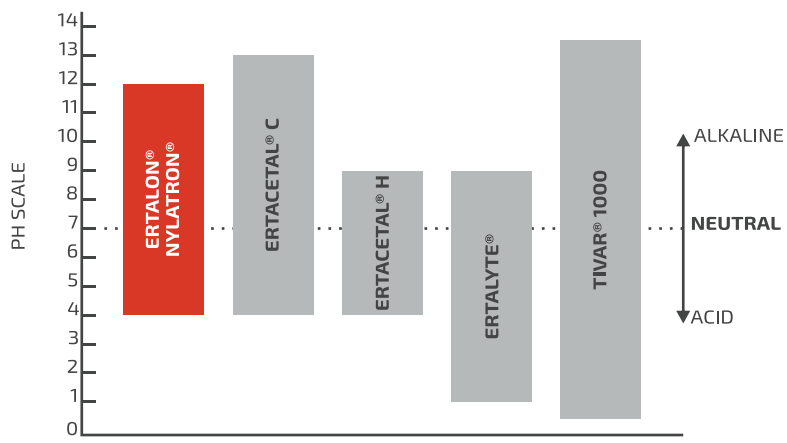



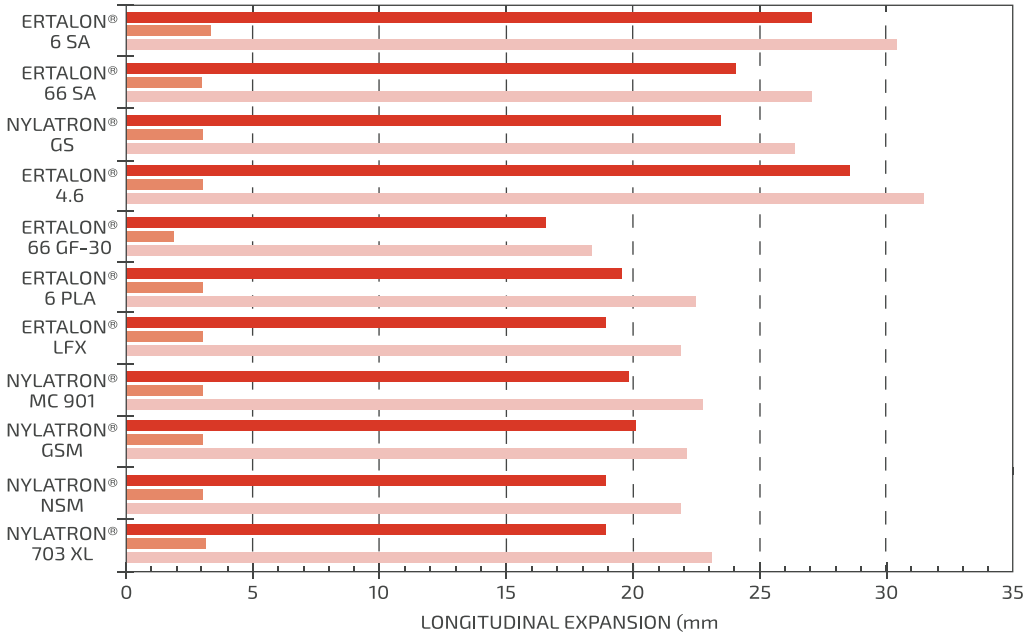

**TEST CONDITIONS**

- Expansion of a long strip of 1,000mm (dry, 23°C) when immersed in water at 60°C

**CAPTION**

- Expansion caused by the absorption of water in complete saturation
- Expansion caused by the increase in temperature from 23°C to 60°C
- Total expansion

ERTALON®  
NYLATRON®

**TENSILE STRESS ON ELASTIC LIMIT STRESS/RUPTURE\* AT 23°C (ISO 527)**

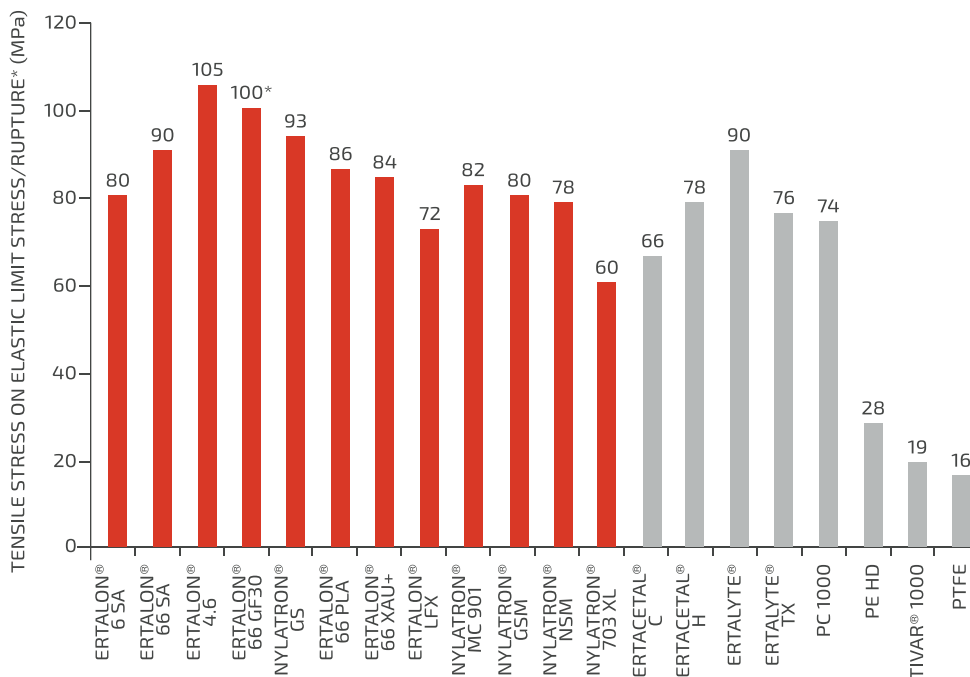

**TEST CONDITIONS**

- Measured on dry samples



PA

# WEAR RESISTANCE AT 23°C

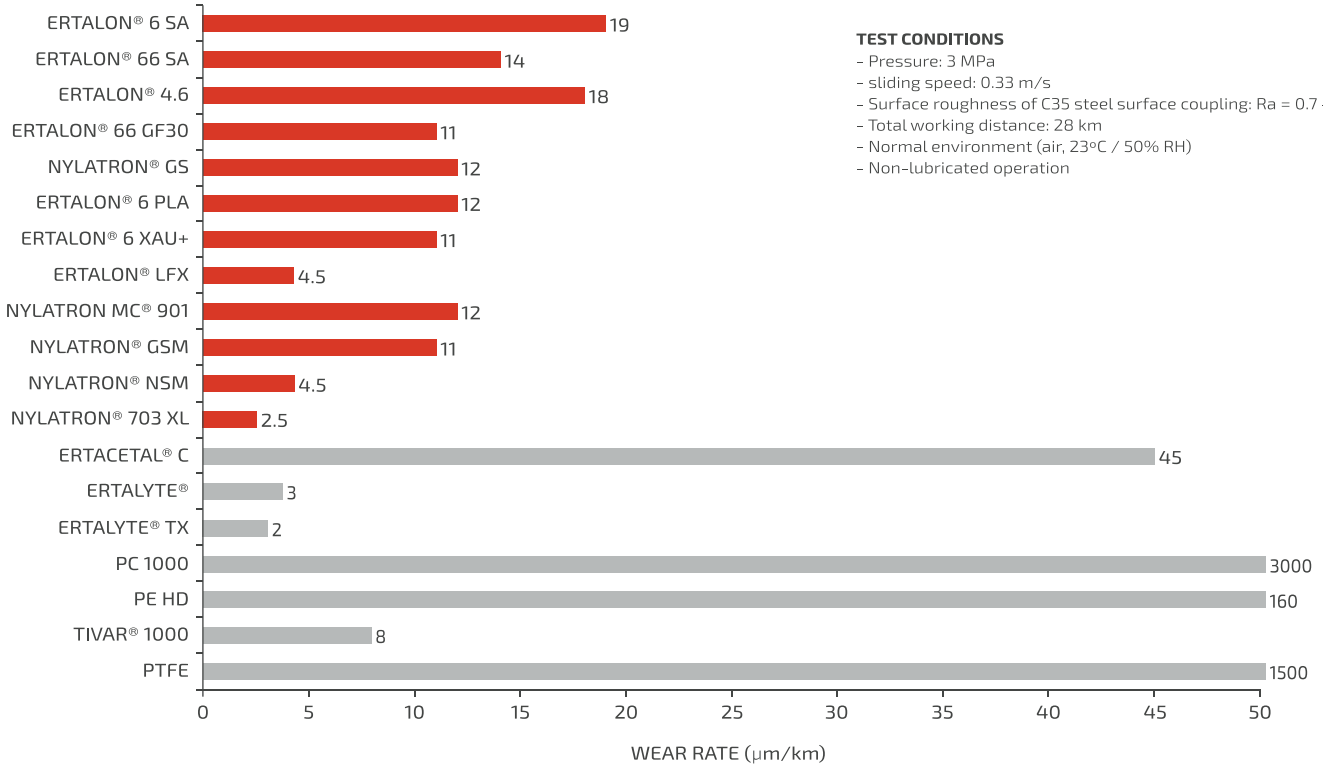

# COMPRESSION STRESS AT 23°C (ISO 604)

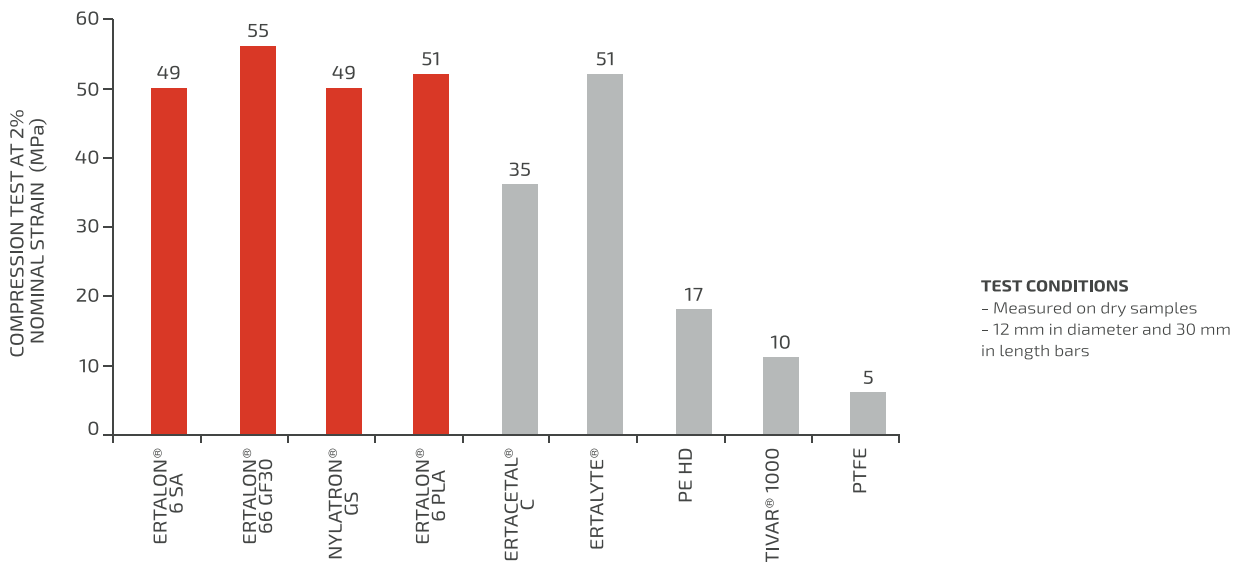

PA  
**ROCKWELL HARDNESS M AT 23°C (ISO 2039-2)**

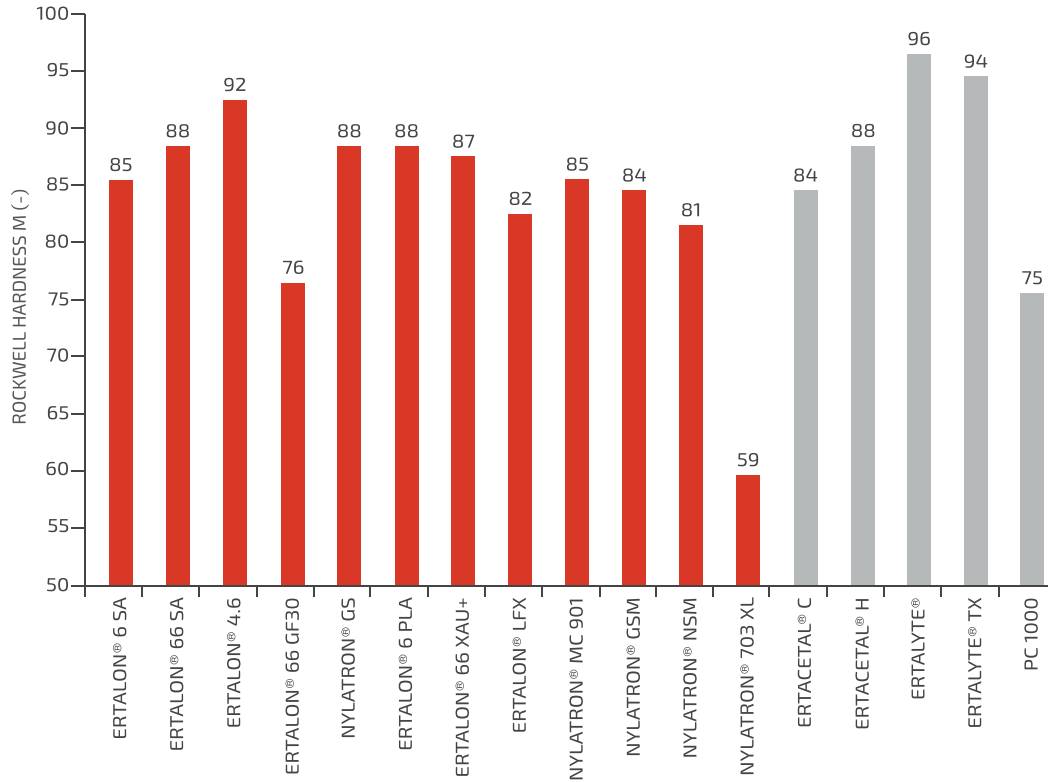

**DYNAMIC FRICTION COEFFICIENT AT 23°C**

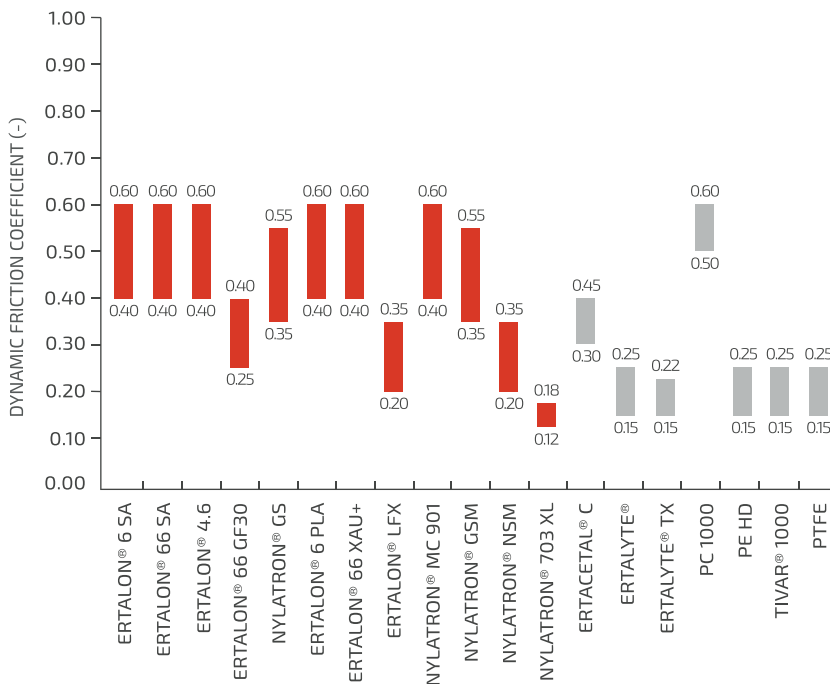

**TEST CONDITIONS**

- Pressure: 3 MPa
- sliding speed: 0,33 m/s
- Surface roughness of C35 steel surface coupling: Ra = 0.7 - 0.9 µm
- Total working distance: 28 km
- Normal environment (air, 23°C / 50% RH)
- Non-lubricated operation



PA

## HYDROLYSIS RESISTANCE

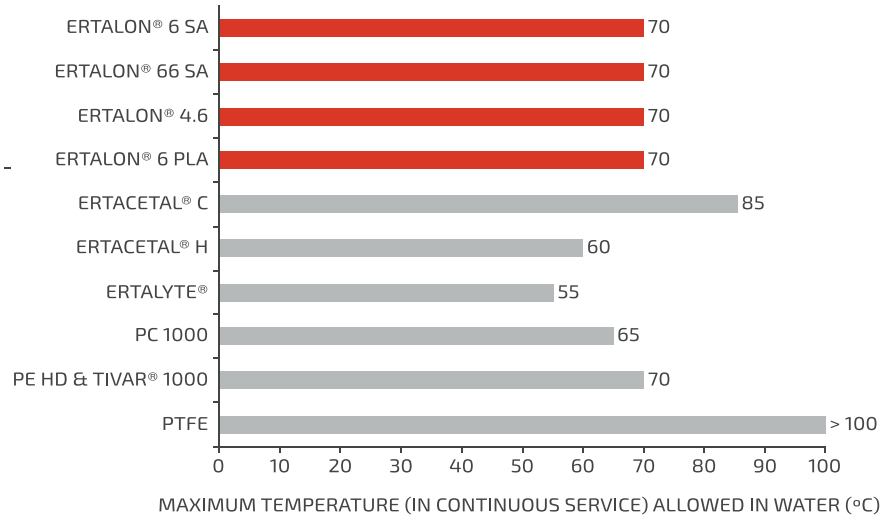

## SUNLIGHT RESISTANCE (UV RAYS)

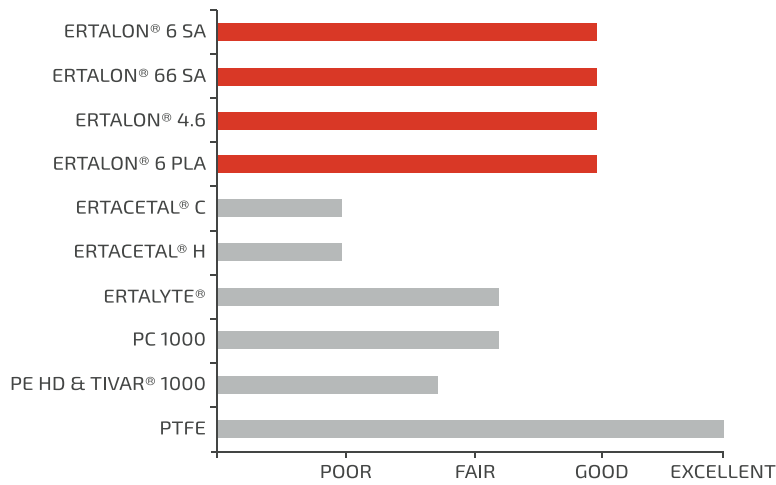

# RESISTANCE AGAINST IONIZING RADIATION (GAMA RAYS)

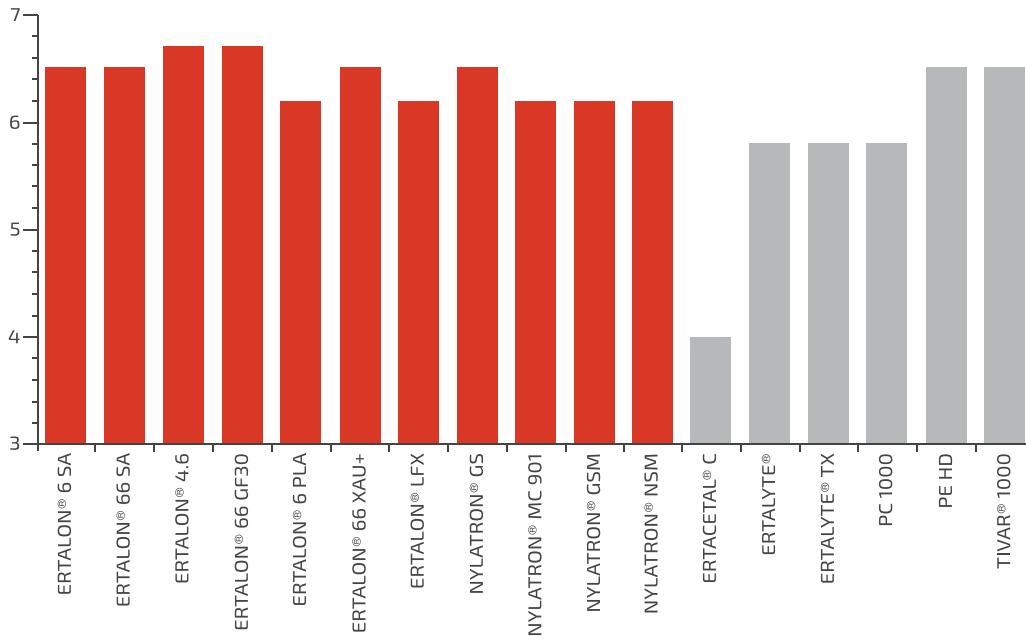

1 Gray = 100 Rad  
 10<sup>6</sup> Gray = 100 Mrad  
 1 Mrad = 10 kJ/kg

The radiation index (RI) is defined as the logarithm, base 10, of the dose absorbed in the GRAY in which the flexural stress at rupture or flexural tension at rupture of the tested material is reduced to 50% of its original value under irradiation conditions (the most sensitive to radiation)

**THINKING OF YOU, WE CUT THE MATERIALS TO YOUR MEASURE!**





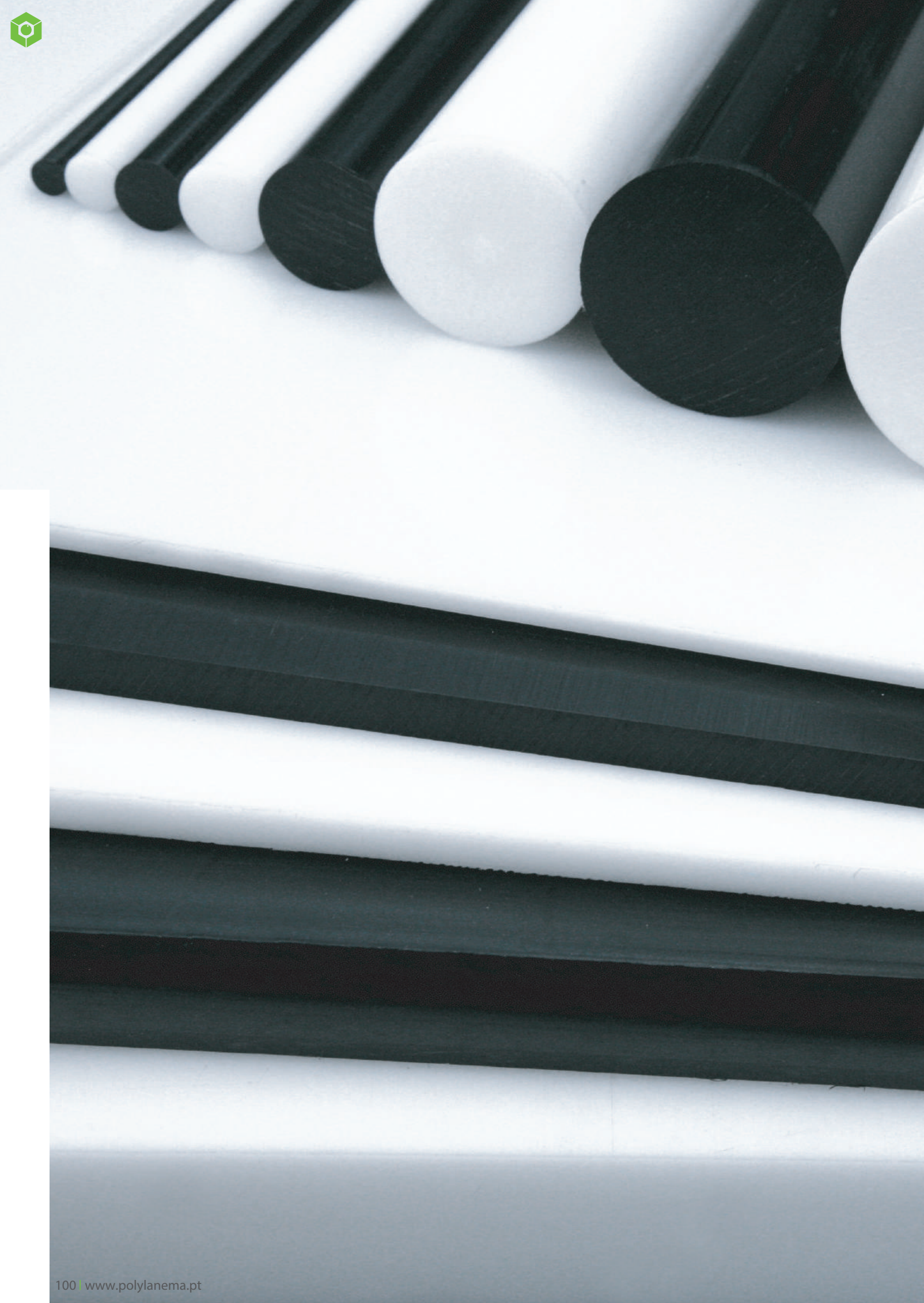



# ERTACETAL® / ACETRON®

POM

Ertacetal® C		104
Ertacetal® H		105
Acetron® MD		108
POLY-ESD		110
TECHNICAL DATA		112



# INTRODUCTION TO ERTACETAL® /ACETRON®

## ADVANTAGES OF ERTACETAL®

- Excellent machinability
- Physiologically inert
- High resistance to impact even at low temperatures (up to -50°C)
- Very good dimensional stability (low moisture absorption)
- Good sliding properties (hardly any stick-slip)
- Excellent resilience
- Ertacetal C: good alkaline and hydrolysis resistance

## ERTACETAL® C vs ERTACETAL® H

- Free of centreline porosity
- Higher hydrolysis resistance up to 85°C
- Higher chemical resistance in the pH range from 4 to 13
- Higher service air temperature (in continuous service) 100°C
- Lower tensile stress in yield: 66 MPa
- Minor E-Voltage Module = 2800 MPa

## CAUTION WHEN USED IN:

- Outdoor applications (low resistance to UV rays)
- Operation in acidic environment (pH <4)
- Bearings in contact with rough coupling metal surfaces (due to moderate wear resistance)

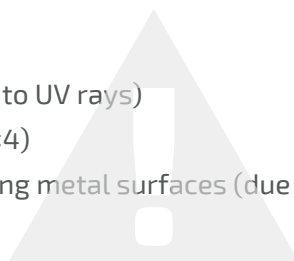



# MAIN CHARACTERISTICS OF ERTACETAL®/ACETRON®

PLASTICS	IMPACT RESISTANCE	WEAR RESISTANCE	SLIDING PROPERTIES	CHEMICAL RESISTANCE	ELECTRICAL INSULATION	TEMPERATURE		
						MIN	MAX*	MAX**
ERTACETAL® C	GOOD	GOOD	GOOD	GOOD	FAIR	-50°	100°	140°
ERTACETAL® H	GOOD	GOOD	FAIR	FAIR	FAIR	-50°	90°	150°
ACETRON® MD	GOOD	GOOD	GOOD	FAIR	FAIR	-30°	90°	140°
POLY-ESD	GOOD	GOOD	GOOD	FAIR	FAIR	-	100°	140°

\*Continuously \*\*For short periods

## FOOD CONTACT



PLASTICS	UE ACC. (EU) 10/2011	USA FDA (21 CFR)	FOOD GRADE
ERTACETAL® C	YES*	YES*	YES
ERTACETAL® H	NO	NO	NO
ACETRON® MD	YES	YES	YES
POLY-ESD	NO	NO	NO

\*Natural, black and blue

## CHEMICAL RESISTANCE

CHEMICAL RESISTANCE AT 23°C	ERTACETAL® C	ERTACETAL® H
Weak acids (diluted)	±	±
Strong acids / Oxidizing chemicals	- /-	- /-
Weak alkalis (diluted)	+	±
Strong alkalis	+	-
Hot water (> 80°C) / Steam	+ /±	± /-
Esters (e.g.: ethyl acetate)/Ketones (e.g.: acetone)	+ /+	+ /+
Aromatic hydrocarbons (e.g. benzene, toluene)	+	+
Aliphatic hydrocarbons (e.g. hexane, octane)	+	+
Lubricating oils and greases	+	+

+ Resistant (in general acceptable useful life)

± Partially resistant (limited useful life)

- Non-resistant

**PRECISION AND QUALITY**  
MACHINING SERVICE







POM ● ○ ● ● ● ● ● ● ● ●

# ERTACETAL® C

**Semi-crystalline plastic,** ERTACETAL® is a material with greater dimensional stability than polyamides despite having a lower resistance to wear. ERTACETAL® C is more resistant to hydrolysis, strong alkaline solutions and degradation by thermal oxidation than ERTACETAL® H.

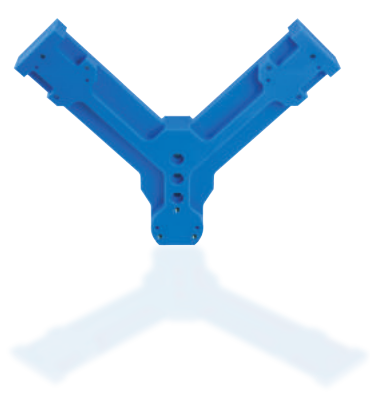

## MAIN CHARACTERISTICS

- High mechanical resistance, stiffness and hardness
- High elasticity module
- Good creep resistance
- High impact resistance even at low temperatures
- Excellent dimensional stability
- Good sliding properties and wear resistance
- Easy machining (better than polyamides)
- Low moisture absorption
- High resistance to chemicals
- Physiologically inert

## APPLICATIONS

- Dimensionally stable precision parts
- Small module sprockets
- Couplings, sleeves, valve elements
- Bushings
- All types of parts that require better finishing and dimensional stability
- Rollers and bearings for heavy loads
- Bearings and gears with small clearances
- Components for electrical insulation



CHEMICAL RESISTANCE



ELECTRICAL INSULATION



WEAR RESISTANCE



SLIDING PROPERTIES



IMPACT RESISTANCE



TEMPERATURE RANGE

\*continuously (20.000H)



**Semi-crystalline plastic**, ERTACETAL® H has a higher mechanical resistance, stiffness, hardness and creep than ERTACETAL® C, as well as lower coefficient of thermal expansion and higher wear resistance.

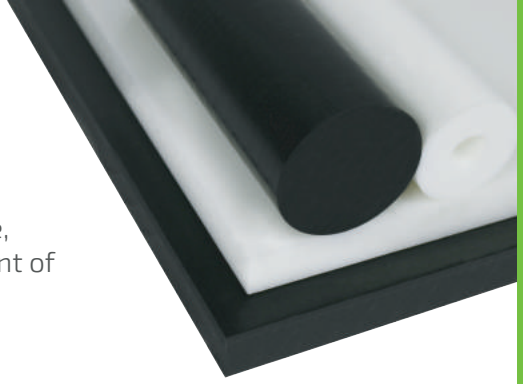

## MAIN CHARACTERISTICS

- High mechanical resistance
- High hardness and rigidity
- Good creep resistance
- Good resistance to wear
- Lower coefficient of thermal expansion

## APPLICATIONS

- Precision parts
- Small module sprockets
- Couplings, sleeves, valve elements
- Bushings
- All types of parts that require better finishing and dimensional stability



CHEMICAL RESISTANCE



ELECTRICAL INSULATION



WEAR RESISTANCE



SLIDING PROPERTIES



IMPACT AO RESISTANCE

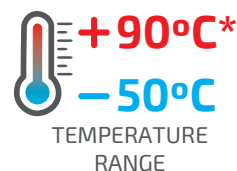

\*continuously (20.000H)





## PLATES

THICKNESS (mm)	TOLERANCES (mm) <sup>(1)</sup>		ERTACETAL® C			ERTACETAL® H			
			KG/PIECE <sup>(2)</sup>	NATURAL	BLACK	BLUE	KG/PIECE <sup>(2)</sup>	NATURAL	BLACK
Standard size 610 x 3000 mm <sup>(3)</sup>									
8	+0.2	+0.9	22.95	●	●	○	23.10	○	○
10			28.32	●	●	○	28.50	●	○
12	+0.3	+1.5	34.65	●	●	○	34.80	○	○
15			42.60	●	●	○	42.90	○	○
16			45.30	●	●	○	45.60	●	●
18			50.70	○	○	○	51.15	○	○
20			56.10	●	●	●	56.55	●	●
25	+0.5	+2.5	69.45	●	●	○	70.05	●	●
30			84.60	●	●	●	85.20	●	●
35			97.95	●	●	○	98.70	○	○
40			111.30	●	●	●	112.20	●	●
45			124.80	○	○	○	125.70	○	○
50	+0.5	+3.5	138.15	●	●	○	139.20	○	●
60			166.35	●	●	●	-	-	-
70			193.20	●	●	○	-	-	-
80	+0.5	+5.0	222.00	●	●	○	-	-	-
90			243.85	●	●	○	-	-	-
100			275.70	●	●	○	-	-	-
120	+0.5	+6.0	330.60	●	●	○	-	-	-
150	+0.5	+7.0	421.20	● <sup>(4)</sup>	● <sup>(4)</sup>	-	-	-	-
Standard size 610 1000 x 2000 mm <sup>(3)</sup>									

Ertacetal C also available in: green, brown, gray, orange, red and yellow.

For more information, please contact us.

(1): tolerances according to DIN EN 15860

(2): average weights of production

(3): tolerances in width + 5 / + 25mm; in length 0 / + 3%

(4): available only with width 625mm

(5): tolerances in width + 20 / + 45mm; in length 0 / + 3%

## SHEETS

THICKNESS (mm)	TOLERANCES (mm) <sup>(1)</sup>		ERTACETAL® C	
			KG/PIECE <sup>(2)</sup>	NATURAL
Standard size 1000 x 2000 mm <sup>(3)</sup>				
1	-0.10	+0.10	2.90	○
1.5			4.36	○
2	-0.15	+0.15	5.82	●
2.5			7.26	○
3	-0.20	+0.20	8.72	●
4			11.60	●
5			14.50	●
6	-0.25	+0.25	17.45	●
Other standard sizes 1000 x 1000 mm <sup>(3)</sup>				

(1): tolerances according to DIN EN 15860

(2): average weights of production

(3): tolerances in length -0 / + 3%

## TUBES

DIAM. (mm) Ø O.D. x Ø I.D.	TOLERANCES <sup>(1)</sup> (mm)		ERTACETAL® C				
	Ø O.D.	Ø I.D.	KG/PEÇA <sup>(2)</sup>	NATURAL	BLACK		
Standard length 3000 mm <sup>(3)</sup>							
30 x 20	+0.4	+1.1	-0.4	-1.1	1.94	●	○
40 x 20					4.56	○	○
45 x 30	+0.6	+2.0	-0.6	-2.0	4.44	●	○
50 x 30					6.09	●	●
55 x 35	+0.8	+2.5	-0.8	-2.5	7.08	○	●
60 x 30					10.11	●	○
60 x 40					7.86	●	○
70 x 30	+0.8	+3.0	-0.8	-4.5	14.91	○	●
70 x 50					9.63	●	○
80 x 40	+0.8	+3.0	-0.8	-3.0	17.73	●	○
80 x 50					14.82	○	●
80 x 60					11.25	●	○
90 x 50	+1.2	+3.6	-1.6	-5.0	21.45	●	○
100 x 50					27.99	○	●
150 x 100	+1.5	+4.5	-2.0	-6.5	48.00	○	○
200 x 150					69.90	●	○
250 x 200	+3.0	+11.0	-3.5	-14.0	96.00	○	○
Other standard lengths 1000 mm <sup>(3)</sup>							

Other measures available on request, subject to special conditions

(1): tolerances according to DIN EN 15860, with the exception of pipes with diameters 70 x 30

(2): average weights of production

(3): tolerances in length -0 / + 3%

- Standard: generally available from stock
- Semi-standard: generally not available from stock
- Non-standard: generally not available from stock, manufactured to order and subject to special conditions

## ROUND RODS

DIAMETER (mm)	TOLERANCES (mm) <sup>(1)</sup>		ERTACETAL® C			ERTACETAL® H		
			KG/PEÇA <sup>(2)</sup>	NATURAL	BLACK	BLUE	KG/PIECE <sup>(2)</sup>	NATURAL
Standard length 3000 mm <sup>(3)</sup>								
3	+0.1	+0.3	0.04	●	-	-	-	-
4			0.06	●	-	-	-	-
5	+0.1	+0.4	0.10	●	○	-	0.10	○
6			0.14	●	○	-	0.14	○
8	+0.1	+0.5	0.24	●	●	-	0.24	○
10			0.36	●	●	-	0.36	○
12	+0.2	+0.7	0.53	●	●	-	0.53	○
14			0.71	●	●	-	0.72	○
15			0.81	●	●	○	0.82	○
16			0.92	●	●	○	0.93	○
18			1.16	●	●	○	1.16	○
20			1.42	●	●	●	1.43	○
22	+0.2	+0.9	1.73	●	●	○	1.74	○
25			2.22	●	●	○	2.24	○
28			2.70	●	●	○	2.79	○
30			3.18	●	●	○	3.18	○
32			3.63	●	●	○	3.66	○
36			4.56	●	●	○	4.59	○
40	+0.2	+1.1	5.61	●	●	○	5.64	○
45			7.11	●	●	○	7.17	○
50			8.76	●	●	○	8.82	○
56			10.95	●	●	○	11.01	○
60	+0.3	+1.6	12.60	●	●	●	12.69	○
65			14.76	●	●	○	14.85	○
70			17.07	●	●	○	17.19	○
75	+0.4	+2.0	19.71	●	●	○	19.83	○
80			22.38	●	●	●	22.53	○
85	+0.5	+2.2	25.29	●	○	○	25.47	○
90			28.29	●	●	○	28.50	○
100	+0.6	+2.5	34.95	●	●	●	35.25	○
110	+0.7	+3.0	42.45	●	●	○	42.75	-
120	+0.8	+3.0	50.70	●	●	○	51.00	-
125			54.90	○	●	○	55.20	-
130	+0.9	+3.8	59.40	●	●	○	59.85	-
140			68.70	●	●	-	69.30	-
150	+1.0	+4.2	79.05	●	●	○	79.65	-
160	+1.1	+4.5	90.00	●	●	○	90.60	-
170	+1.2	+5.0	101.70	○	○	-	102.45	-
180			113.70	●	●	-	114.60	-
200	+1.3	+5.5	140.40	●	●	○	141.30	-
210	+1.3	+5.8	154.80	○	○	-	-	-
220			169.50	●	○	-	-	-
230	+1.5	+6.2	185.55	●	○	-	-	-
250			218.55	●	●	-	-	-
280	+1.6	+6.5	273.45	●	○	-	-	-
300	+1.7	+7.0	314.10	●	●	-	-	-
320	+1.8	+7.4	357.00	●	○	-	-	-
500	+3.0	+13.0	862.20	●	○	-	-	-
Other standard lengths 1000 mm <sup>(3)</sup>								

Ertacetal C also available in: green, brown, gray, orange, red and yellow. For more information, please contact us.

(1): tolerances according to DIN EN 15860

(2): average weights of production

(3): tolerances in length -0 / + 3%

- Standard: generally available from stock
- Semi-standard: generally not available from stock
- Non-standard: generally not available from stock, manufactured to order and subject to special conditions



POM ●

# ACETRON® MD

**Semi-crystalline plastic**, this acetal copolymer contains a metal detectable additive and has been specifically adapted for use in the food processing and packaging industries where it can be easily traced by conventional metal detection systems installed to detect food contamination ( the results may vary depending on the sensitivity of the metal detection system used). ACETRON® MD has good mechanical resistance, stiffness and impact resistance, as well as a composition compatible with food contact.



## MAIN CHARACTERISTICS

- Continuous temperature up to 105°C
- Metal and visual detection by means of the blue colour; metal detection level for particles 3mm x 3mm x 3mm
- X-ray detection is also possible
- High dimensional stability

## APPLICATIONS

- Hoppers
- Gears
- Scrappers
- Claws
- Guides



CHEMICAL RESISTANCE



ELECTRICAL INSULATION



WEAR RESISTANCE



SLIDING PROPERTIES



IMPACT RESISTANCE

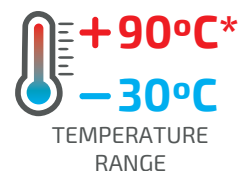

TEMPERATURE RANGE

\*continuously (20.000H)

## ROUND RODS

DIAMETERS (mm)	TOLERANCES (mm) <sup>(1)</sup>		KG/PIECE <sup>(2)</sup>	STOCK
Standard length 3000 mm <sup>(3)</sup>				
30	+0.2	+1.2	3.36	●
50	+0.3	+2.0	9.33	●
80	+0.4	+3.0	23.82	●
125	+0.8	+3.5	57.60	●
Other standard lengths 1000 mm <sup>(3)</sup>				

(1): tolerances according to DIN EN 15860  
 (2): average weights of production  
 (3): tolerances in length -0 / + 3%

## PLATES

THICKNESS (mm)	TOLERANCES (mm) <sup>(1)</sup>		KG/PIECE <sup>(2)</sup>	STOCK
Standard size 610 x 3000 mm <sup>(3)</sup>				
20	+0.3	+1.5	59.40	●
40	+0.5	+2.5	117.90	●
80	+0.5	+5.0	234.90	●
Other standard sizes 610 x 1000 mm <sup>(3)</sup>				

(1): tolerances according to DIN EN 15860  
 (2): average weights of production  
 (3): tolerances in length -0 / + 3%



**REDUCE YOUR COSTS WITH OUR WATER JET CUTTING SERVICE!**

● Standard: generally available from stock  
 ● Semi-standard: generally not available from stock  
 ○ Non-standard: generally not available from stock, manufactured to order and subject to special conditions



POM ●

# POLY-ESD

Poly-ESD is a conductive polyacetal. This class is designed specifically for use in applications where POM C characteristics are required, but with the added benefit of good electrical conductivity, such as in electrical applications and explosion sensitive areas. For ATEX (explosive atmosphere) cases, conductivity should be <math><109\text{ Ohm}</math> (surface resistivity measurement).

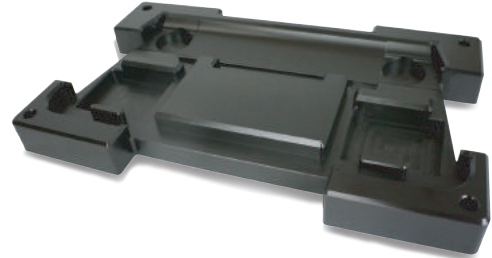
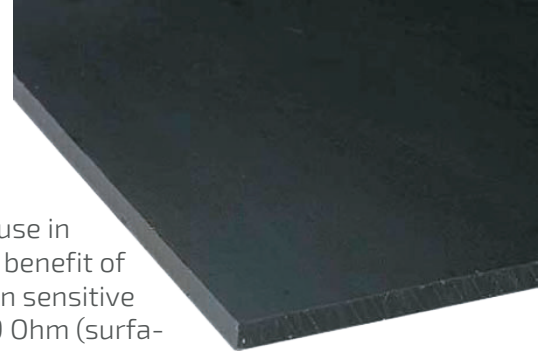

## MAIN CHARACTERISTICS

- Electrostatic discharge (ESD)
- High mechanical resistance, stiffness and creep
- Excellent dimensional stability
- Excellent machining (better than Polyamides and Polyethylene)
- Low water absorption

## APPLICATIONS

- In general, all applications where good thermal conductivity is required, associated with good dimensional stability and good surface finish.



CHEMICAL RESISTANCE



ELECTRICAL INSULATION



WEAR RESISTANCE



SLIDING PROPERTIES



IMPACT RESISTANCE

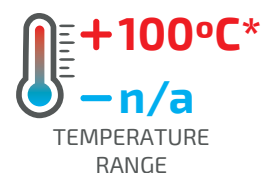

TEMPERATURE RANGE

\*continuously (20.000H)



## PLATES

THICKNESS (mm)	STOCK
610 x 3000 mm	
12	●
15	●
20	●
25	●
POLY 30	●
40	●
50	●
60	●
80	●

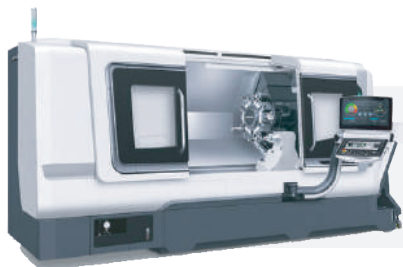

WE SUPPLY **MODERN AND  
PRECISE** CNC EQUIPMENT!

- Standard: generally available from stock
- ◐ Semi-standard: generally not available from stock
- Non-standard: generally not available from stock, manufactured to order and subject to special conditions





# POM

## TECHNICAL DATASHEET

PROPERTIES	TEST METHODS	UNITS	ERTACETAL® C	ERTACETAL® H	ACETRON® MD	POLY ESD
COLOR		-	WHITE/BLACK*	WHITE/BLACK	BLUE	BLACK
DENSITY	ISO 1183-1	g/cm <sup>3</sup>	1.41	1.43	1.46	1.41
WATER ABSORPTION						
AFTER 24/96H IMMERSION IN WATER OF 23°C <sup>1</sup>	ISO 62	mg	20/37	18/36	19/37	-
AFTER 24/96H IMMERSION IN WATER OF 23°C <sup>1</sup>	ISO 62	%	0.24/0.45	0.21/0.43	0.21/0.40	-
AT SATURATION IN AIR OF 23°C / 50% RH	-	%	0.20	0.20	0.19	0.20
AT SATURATION IN WATER OF A 23°C	-	%	0.80	0.80	0.75	0.80
THERMAL PROPERTIES <sup>2</sup>						
MELTING TEMPERARUTE (DSC, 10°C/MIN)	ISO 11357-1/-3	°C	165	180	165	173
GLASS TRANSITION TEMPERATURE (DSC, 20°C/MIN) <sup>3</sup>	ISO 11357-1/-3	°C	-	-	-	-
THERMAL CONDUCTIVITY A 23°C	-	W/(K.m)	0.31	0.31	0.31	-
COEFFICIENT OF LINEAR THERMAL EXPANSION						
AVERAGE VALUE BETWEEN 23-60°C	-	M/(m.K)	110 x 10 <sup>-6</sup>	95 x 10 <sup>-6</sup>	115 x 10 <sup>-6</sup>	110 x 10 <sup>-6</sup>
AVERAGE VALUE BETWEEN 23-100°C	-	M/(m.K)	125 x 10 <sup>-6</sup>	110 x 10 <sup>-6</sup>	130 x 10 <sup>-6</sup>	125 x 10 <sup>-6</sup>
TEMPERATURE OF DEFLECTION UNDER LOAD						
METHOD A 1.8 MPA	+ ISO 75-1/-2	°C	100	110	100	105
MAXIMUM ALLOABLE SERVICE TEMPERATURE IN AIR						
FOR SHORT PERIODS <sup>4</sup>	-	°C	140	150	140	140
CONTINUOUSLY: FOR 5.000/20.000H <sup>5</sup>	-	°C	115/100	105/90	105/90	115/100
MINIMUM SERVICE TEMPERATURE <sup>6</sup>	-	°C	-50	-50	-30	-
FAMMABILITY <sup>7</sup>						
"OXYGEN INDEX"	ISO 4589-1/-2	%	15	15	< 20	-
ACCORDING TO UL94 (3/6MM DE ESPESSURA)	-	-	HB/HB	HB/HB	HB/HB	HB/HB
MECHANICAL PROPERTIES AT 23°C <sup>8</sup>						
TENSION TEST <sup>9</sup>						
TENSILE STRESS AT YIELD/AT BREAK <sup>10</sup>	+ ISO 527-1/-2	MPa	66/-	78/-	66/-	- /30
TENSILE STRESS AT YIELD/AT BREAK <sup>10</sup>	++ ISO 527-1/-2	MPa	66/-	78/-	66/-	- / 30
TENSILE STRENGTH <sup>10</sup>	+ ISO 527-1/-2	MPa	66	78	66	30
TENSILE STRAIN AT YIELD <sup>10</sup>	+ ISO 527-1/-2	%	20	40	14	-
TENSILE STRAIN AT BREAK <sup>10</sup>	+ ISO 527-1/-2	%	50	50	15	8
TENSILE STRAIN AT BREAK <sup>10</sup>	++ ISO 527-1/-2	%	50	50	15	-
TENSILE MODULUS OF ELASTICITY <sup>11</sup>	+ ISO 527-1/-2	MPa	2800	3300	2950	1500
TENSILE MODULUS OF ELASTICITY <sup>11</sup>	++ ISO 527-1/-2	MPa	2800	3300	2950	-
COMPRESSION TEST <sup>12</sup>						
COMPRESSIVE STRESS AT 1/2/5% NOMINAL STRAIN <sup>11</sup>	+ ISO 604	MPa	23/40/72	29/49/85	25/44/76	14/-/37
CHARPY IMPACT STRENGTH - UNNOTCHED <sup>13</sup>	+ ISO 179-1/1eU	KJ/m <sup>2</sup>	NO BREAK	NO BREAK	70	89
CHARPY IMPACT STRENGTH - NOTCHED	+ ISO 179-1/1eA	KJ/m <sup>2</sup>	8	10	5	5
BALL IDENTATION HARDNESS <sup>14</sup>	+ ISO 2039-1	N/mm <sup>2</sup>	140	160	155	77
ROCKWELL HARDNESS <sup>14</sup>	+ ISO 2039-2	-	M 84	M 88	M 86	M 45
ELECTRICAL PROPERTIES AT 23°C						
ELECTRIC STRENGTH <sup>15</sup>	+ IEC 60243-1	kV/mm	20	20	-	-
ELECTRIC STRENGTH <sup>15</sup>	++ IEC 60243-1	kV/mm	20	20	-	-
VOLUME RESISTIVITY	+ IEC 60093	Ohm.cm	> 10 <sup>14</sup>	> 10 <sup>14</sup>	> 10 <sup>13</sup>	-
VOLUME RESISTIVITY	++ IEC 60093	Ohm.cm	> 10 <sup>14</sup>	> 10 <sup>14</sup>	> 10 <sup>13</sup>	-
SURFACE RESISTIVITY	+ IEC 60093	Ohm	> 10 <sup>13</sup>	> 10 <sup>13</sup>	> 10 <sup>12</sup>	< 10 <sup>4</sup>
SURFACE RESISTIVITY	++ IEC 60093	Ohm	> 10 <sup>13</sup>	> 10 <sup>13</sup>	> 10 <sup>12</sup>	-
RELATIVE PERMITTIVITY ε <sub>r</sub> : A 100HZ	+ IEC 60250	-	3.8	3.8	-	-
RELATIVE PERMITTIVITY ε <sub>r</sub> : A 100HZ	++ IEC 60250	-	3.8	3.8	-	-
RELATIVE PERMITTIVITY ε <sub>r</sub> : A 1MHZ	+ IEC 60250	-	3.8	3.8	-	-
RELATIVE PERMITTIVITY ε <sub>r</sub> : A 1MHZ	++ IEC 60250	-	3.8	3.8	-	-
DIELECTRIC DISSIPATION FACTOR TAN δ : A 100HZ	+ IEC 60250	-	0.003	0.003	-	-
DIELECTRIC DISSIPATION FACTOR TAN δ : A 100HZ	++ IEC 60250	-	0.003	0.003	-	-
DIELECTRIC DISSIPATION FACTOR TAN δ : A 1MHZ	+ IEC 60250	-	0.008	0.008	-	-
DIELECTRIC DISSIPATION FACTOR TAN δ : A 1MHZ	++ IEC 60250	-	0.008	0.008	-	-
COMPARATIVE TRACKING INDEX (CTI)	+ IEC 60112	-	600	600	-	-
COMPARATIVE TRACKING INDEX (CTI)	++ IEC 60112	-	600	600	-	-

(1) According to method 1 of ISO 62 and measured on ø 50x3 mm discs. (2) The elements supplied for this property are for the most part supplied by the manufacturers of the raw materials. (3) The values of this property are only attributed to amorphous rather than semi-crystalline materials. (4) Only for short periods of exposure in applications where only very low loads are applied to the material. (5) Temperature that resists after a period of 5,000 / 20,000 hours. After this time, there is a decrease of about 50% in tensile strength compared to the original value. The given temperature values are based on the thermal oxidation degradation which occurs which causes a reduction of the properties. In the meantime, the maximum permissible service temperature depends in many cases essentially on the deduction and magnitude of the mechanical stresses to which the material is subject. (6) As the impact strength decreases with decreasing temperature, the minimum allowable service temperature is determined by the extent of impact to which the material is subjected. The values given are based on unfavorable impact conditions and can not therefore be considered absolute limits.

NOTE: 1 g/cm<sup>3</sup> = 1000 kg/m<sup>3</sup> ; 1 MPa = 1 N/mm<sup>2</sup> ; 1 KV/mm = 1 MV/m  
\* Other colors available on request

+: values for dry material  
++: values referring to material in equilibrium with the standard atmosphere 23°C / 50% rh

# POM MAXIMUM ALLOWABLE SERVICE TEMPERATURE IN AIR

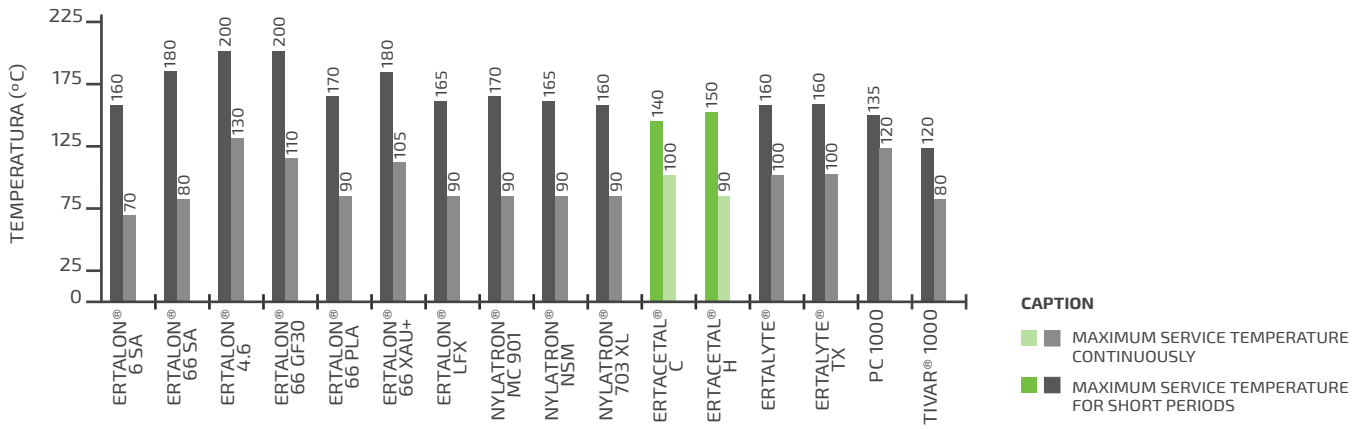

**CAPTION**  
■ MAXIMUM SERVICE TEMPERATURE CONTINUOUSLY  
■ MAXIMUM SERVICE TEMPERATURE FOR SHORT PERIODS

## RIGIDITY vs. TEMPERATURE

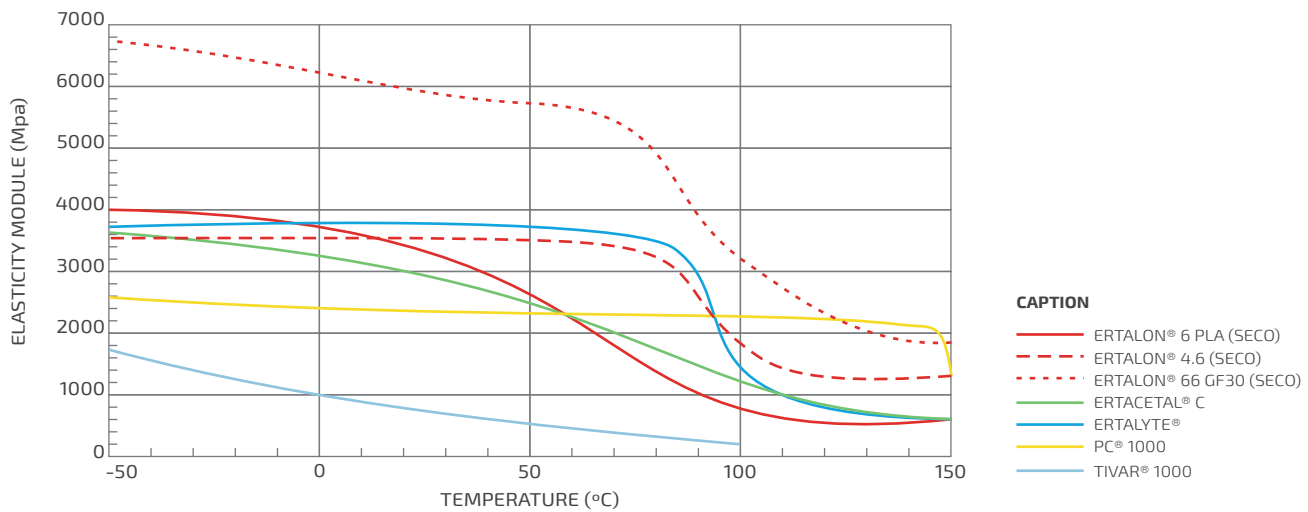

**CAPTION**  
— ERTALON® 6 PLA (SECO)  
- - - ERTALON® 4.6 (SECO)  
· · · ERTALON® 66 GF30 (SECO)  
— ERTACETAL® C  
— ERTALYTE®  
— PC® 1000  
— TIVAR® 1000

## CHEMICAL RESISTANCE AT 23°C

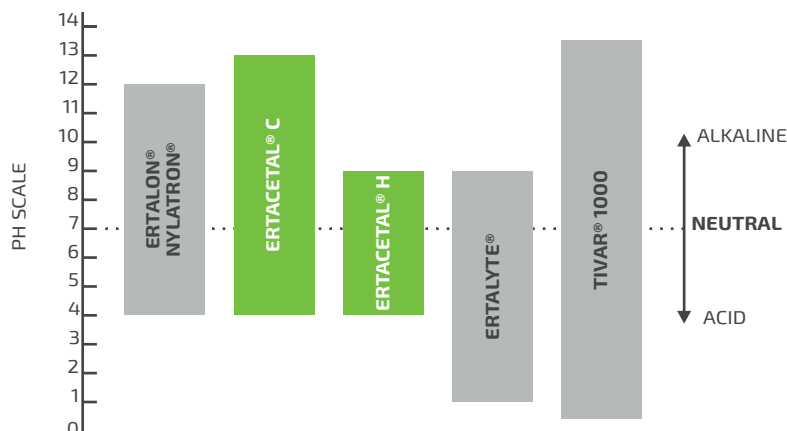

(7) These assessments derive from the technical specifications of the manufacturers of the raw materials and do not allow the determination of the behavior of the materials under fire conditions.  
 (8) Most of the figures given by the properties of the (+) materials are mean values of the tests done on species machined with ø 40-60 mm. (9) Specimen testing: Type 1b. (10) Speed test: 5 or 50 mm / min. (11) Speed test: 1m / min. (12) Testing specimens: cylinders ø 8 x 16 mm. (13) Pendulum used: 15J. (14) Test on 10 mm thick specimens. (15) Electrode configuration: cylinders ø 25 / ø 75 mm, in transformer oil according to IEC 60296.

Note that the electrical force for the extruded black material can be considerably lower than that of natural material. The possible micro porosity in the center of conserved forms in stock significantly reduces the electric force.



POM  
**DIMENSIONAL STABILITY**

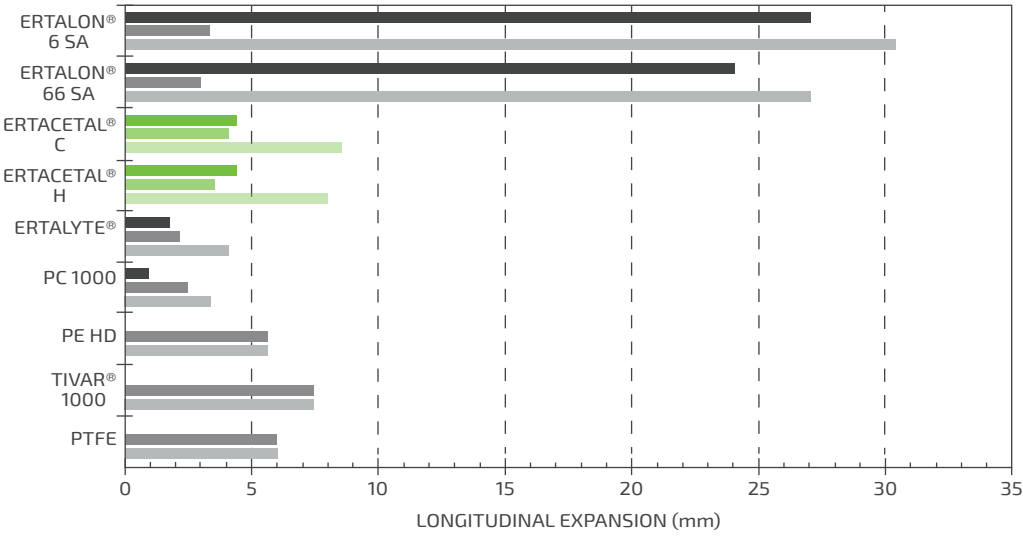

**TEST CONDITIONS**  
- Expansion of a long strip of 1,000mm (dry, 23°C) when immersed in water at 60°C

**CAPTION**

- Expansion caused by the absorption of water in complete saturation
- Expansion caused by the increase in temperature from 23°C to 60°C
- Total expansion

ERTACETAL®  
ACETRON®

**TENSILE STRESS ON ELASTIC LIMIT STRESS/RUPTURE\* AT 23°C (ISO 527)**

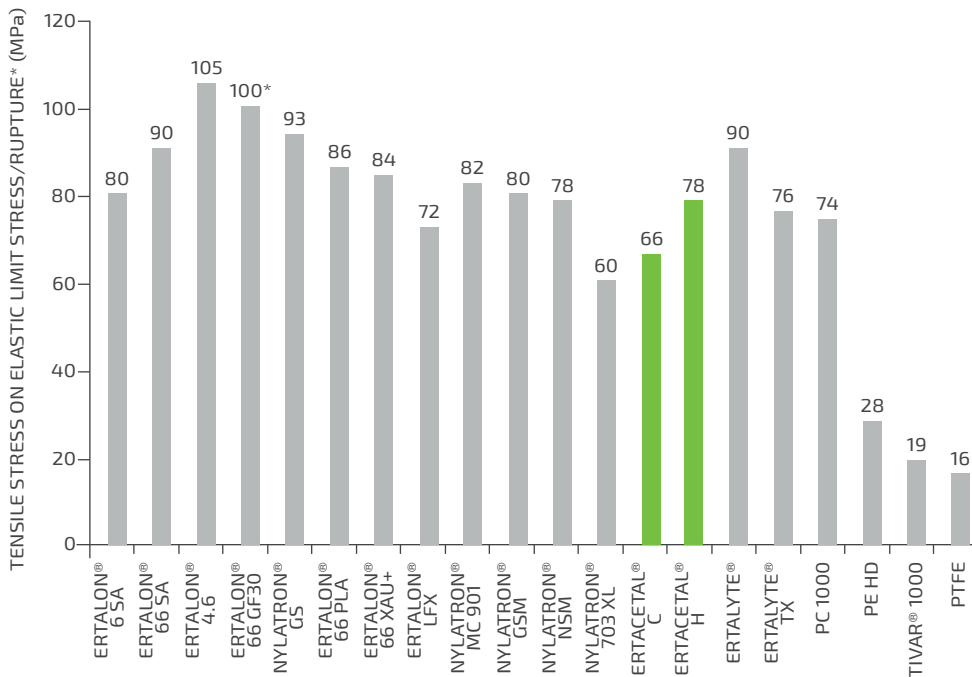

**TEST CONDITIONS**  
- Measured on dry samples

POM  
WEAR RESISTANCE AT 23°C

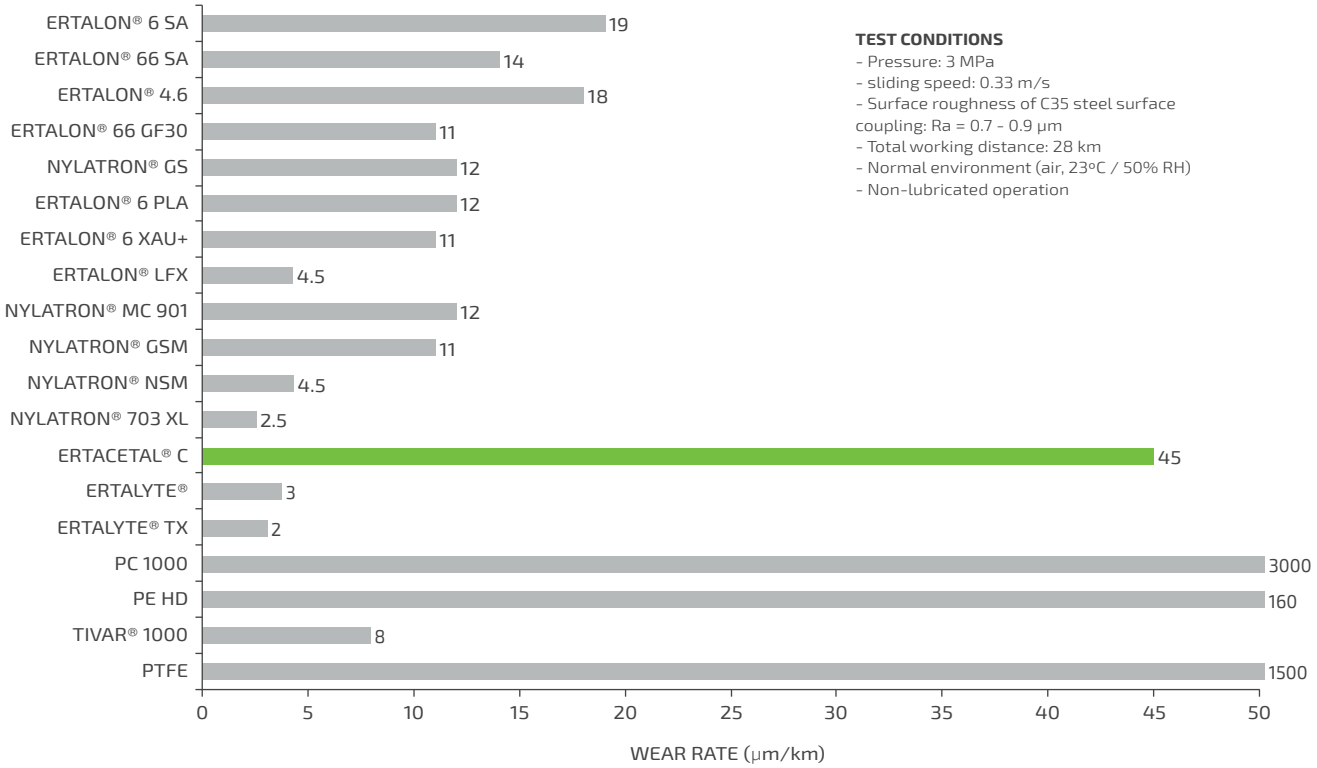

ERTACETAL®  
ACETRON®

COMPRESSION STRESS AT 23°C (ISO 604)

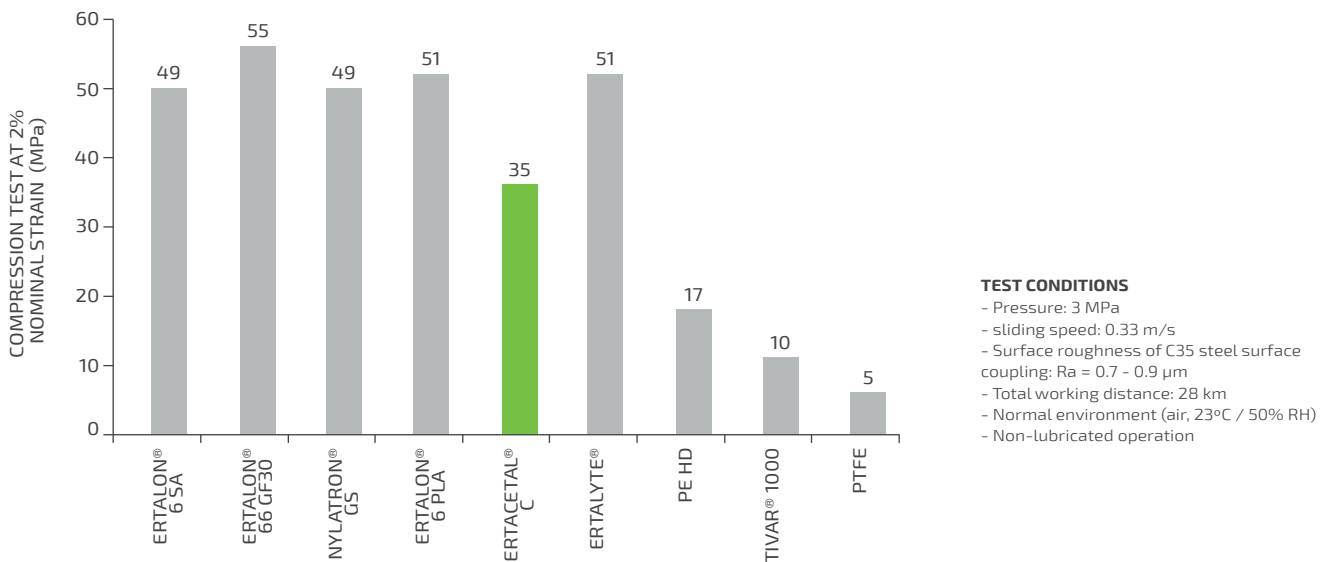



POM

# ROCKWELL HARDNESS M AT 23°C (ISO 2039-2)

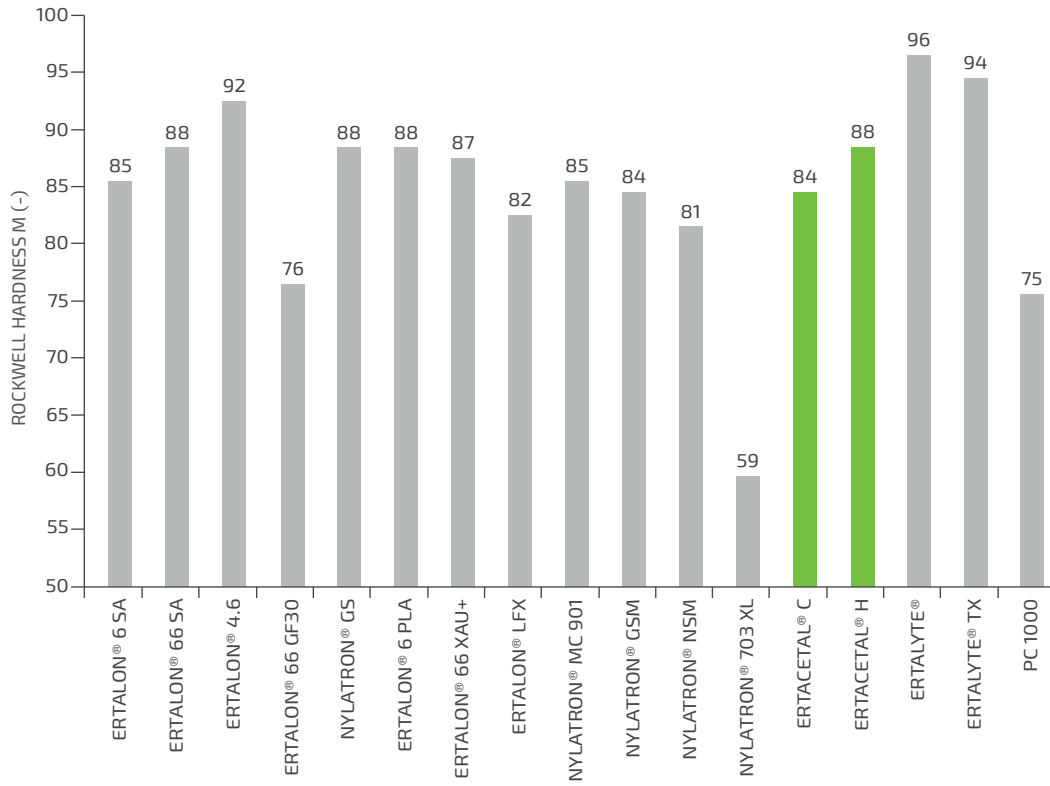

ERTACETAL®  
ACETRON®

# DYNAMIC FRICTION COEFFICIENT AT 23°C

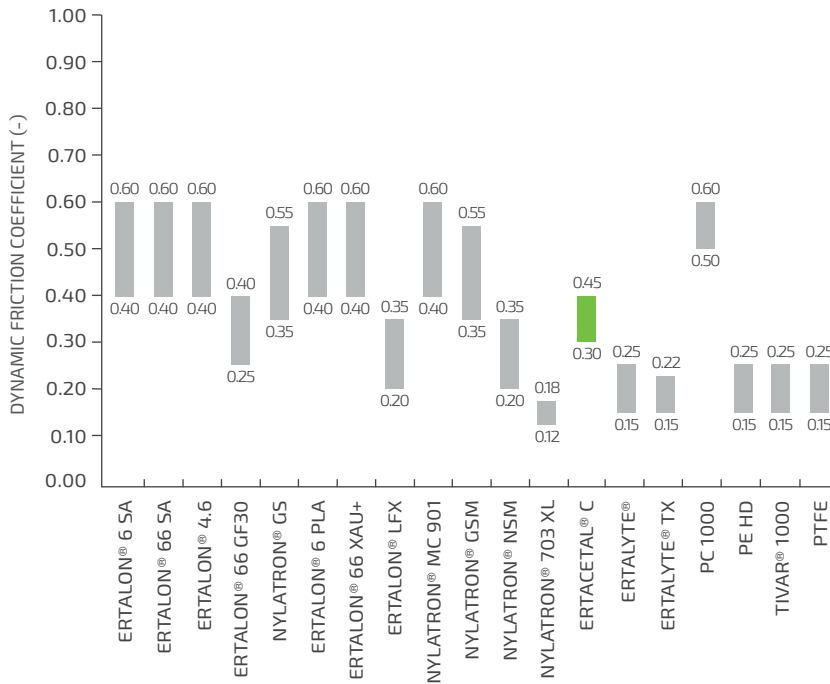

### TEST CONDITIONS

- Pressure: 3 MPa
- sliding speed: 0.33 m/s
- Surface roughness of C35 steel surface coupling: Ra = 0.7 - 0.9 µm
- Total working distance: 28 km
- Normal environment (air, 23°C / 50% RH)
- Non-lubricated operation

# SUNLIGHT RESISTANCE (UV RAYS)

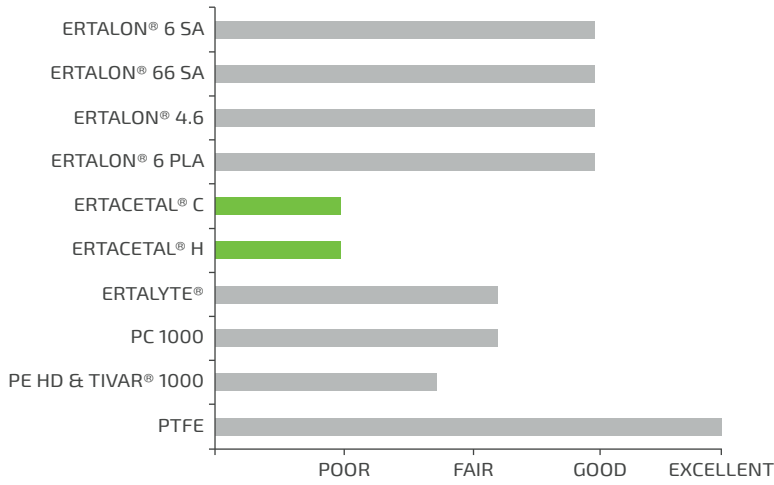

# HYDROLYSIS RESISTANCE

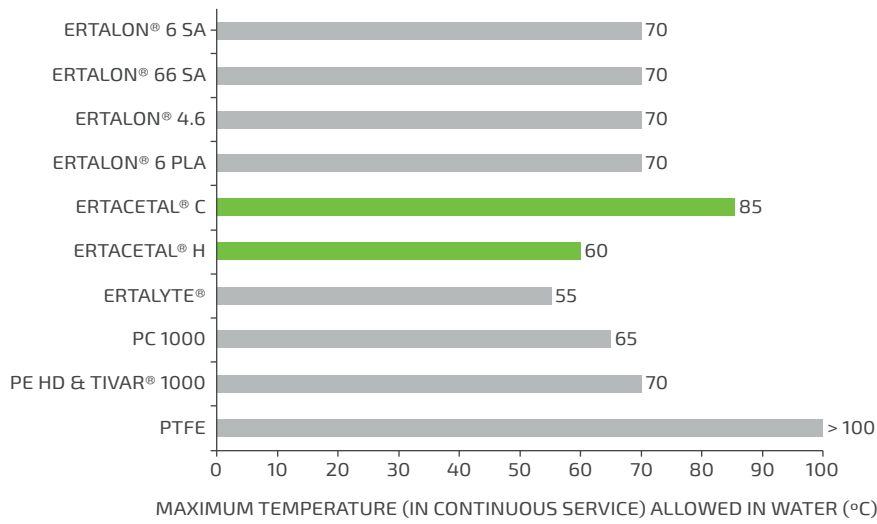

# RESISTANCE AGAINST IONIZING RADIATION (GAMA RAYS)

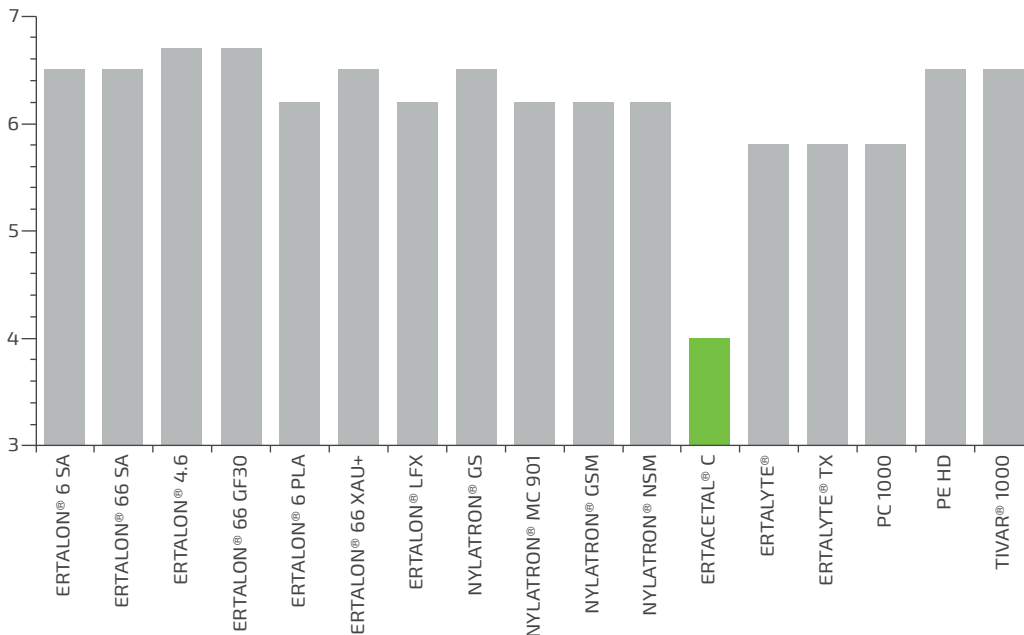

1 Gray = 100 Rad  
 10<sup>6</sup> Gray = 100 Mrad  
 1 Mrad = 10 kJ/kg

The radiation index (RI) is defined as the logarithm, base 10, of the dose absorbed in the GRAY in which the flexural stress at rupture or flexural tension at rupture of the tested material is reduced to 50% of its original value under irradiation conditions (the most sensitive to radiation)







# TIVAR®

## PE

PE-HD		122
Tivar® Tech		125
Tivar® Ceram P		126
Tivar® Cestidur/DS		127
Tivar® H.O.T.		128
Tivar® SuperPlus		129
Tivar® 1000		130
Tivar® 1000 EC		131
Tivar® 1000 TG1		132
Tivar® 1000 Antistatic		133
Tivar® 1000 ASTL		134
Tivar® Dryslide		135
Tivar® QuickSilver		136
Tivar® 88		137
Technical Data		142
Standard Profiles		150
Sliding Guides		160
Spindles and Stars		162



# INTRODUCTION TO TIVAR®

## ADVANTAGES OF TIVAR®

- High resistance to wear and abrasion
- Excellent sliding properties
- Excellent resistance to impact even at low temperatures (up to -200°C for TIVAR® 1000)
- Excellent chemical resistance
- Low density
- Excellent machinability
- Very low water absorption
- Physiologically inert (most qualities)- Excellent electrical and dielectric insulation properties (only unfilled qualities)
- Good resistance to high energy radiation
- Low coefficient of friction

## TIVAR® 1000 vs PE-HD

- Molecular weight of about 5,000,000 g / mol (Tivar® 1000) and 500,000 g / mol (PE-HD)
- Higher resistance to wear and abrasion
- Excellent resistance to impact even at temperatures below -200°C

## CAUTION WHEN USED IN:

- Precision parts (high CLTE:  $150-200 \cdot 10^{-6} \text{ m} / (\text{m} \cdot \text{K})$ )
- Outdoor applications (low UV resistance - except for TIVAR® 1000 antistatic, TIVAR® 1000 EC and TIVAR® 1000 ASTL)
- Heavily loaded components (low tensile and compressive strength, stiffness and creep - e.g. 19 MPa yield for TIVAR® 1000)

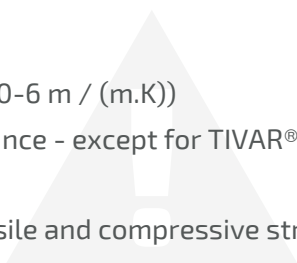



## MAIN CHARACTERISTICS OF TIVAR®

PLASTICS	IMPACT RESISTANCE	WEAR RESISTANCE	SLIDING PROPERTIES	CHEMICAL RESISTANCE	ELECTRICAL INSULATION	TEMPERATURE		
						MIN	MAX*	MAX**
PE-HD	GOOD	FAIR	GOOD	GOOD	GOOD	-100°	80°	120°
TIVAR® Cestidur/DS	GOOD	EXCELLENT	EXCELLENT	GOOD	GOOD	-200°	80°	120°
TIVAR® Ceram P	GOOD	EXCELLENT	GOOD	GOOD	GOOD	-150°	80°	120°
TIVAR® Tech	EXCELLENT	EXCELLENT	EXCELLENT	EXCELLENT	GOOD	-150°	80°	120°
TIVAR® H.O.T.	GOOD	GOOD	GOOD	GOOD	GOOD	-200°	110°	135°
TIVAR® SuperPlus	GOOD	EXCELLENT	EXCELLENT	EXCELLENT	GOOD	-150°	80°	120°
TIVAR® 1000	EXCELLENT	GOOD	GOOD	EXCELLENT	GOOD	-200°	80°	120°
TIVAR® 1000 EC	GOOD	GOOD	GOOD	EXCELLENT	MÉDIO	-150°	80°	120°
TIVAR® 1000 TG1	EXCELLENT	EXCELLENT	EXCELLENT	EXCELLENT	GOOD	-200°	80°	120°
TIVAR® 1000 Antistatic	GOOD	GOOD	GOOD	EXCELLENT	GOOD	-150°	80°	120°
TIVAR® ASTL	GOOD	GOOD	GOOD	GOOD	GOOD	-150°	80°	120°
TIVAR® Dryslide	EXCELLENT	EXCELLENT	EXCELLENT	GOOD	GOOD	-150°	80°	120°
TIVAR® QuickSilver	EXCELLENT	EXCELLENT	EXCELLENT	GOOD	GOOD	-150°	80°	120°
TIVAR® 88	EXCELLENT	EXCELLENT	EXCELLENT	GOOD	GOOD	-200°	80°	90°

\*Continuously \*\*For short periods

## FOOD CONTACT



PLASTICS	UE ACC. (EU) 10/2011	USA FDA (21 CFR)	FOOD GRADE
PE-HD	YES*	YES**	YES
TIVAR® Tech	YES	NO	NO
TIVAR® Ceram P	NO	NO	NO
TIVAR® Cestidur/DS	YES	YES	YES
TIVAR® H.O.T.	YES	YES	YES
TIVAR® SuperPlus	NO	NO	NO
TIVAR® 1000	YES*	YES**	YES
TIVAR® 1000 EC	YES	YES	YES
TIVAR® 1000 TG1	NO	NÃO	NO
TIVAR® 1000 Antistatic	YES	NO	YES
TIVAR® ASTL	YES	NO	NO
TIVAR® Dryslide	NO	NO	NO
TIVAR® QuickSilver	NO	NO	NO
TIVAR® 88	NO	NO	NO

\*Natural, green, blue

\*\*Natural, blue, yellow, red

## CHEMICAL RESISTANCE: COMPARATIVE TABLE OF TIVAR® 1000 WITH OTHER PLASTICS

CHEMICAL RESISTANCE AT 23°C	TIVAR® 1000	PP	POM	PTFE	PA
Water	+	+	+	+	±
Acids	+	+	-	+	-
Alkalis	+	+	+	+	+
Salts	+	+	+	+	+
Halogens	-	-	-	+	-
Oxidising Compounds	-	-	-	+	-
Oil and fat	+	+	+	+	+
Alcohol	+	+	+	+	±
Esters	+	±	+	+	+
Organic acids	+	+	±	+	±
Aromatic	±	-	+	+	+

+ Resistant (in general acceptable useful life)

± Partially resistant (limited useful life)

- Non-resistant



PE ●●●●●○

# PE-HD EXTRUDED (E)/PRESSED (P)

**Semi-crystalline plastic**, physiologically inert, associates a good combination of rigidity, toughness and resilience. It has good chemical resistance and can be easily welded. PE-HD is a versatile polyethylene used primarily in the food industry, as well as in the chemical, mechanical and electrical industries. This material can be obtained by extrusion (E) or by pressing (P). The use of pressed polyethylene is suggested in machined parts and in all applications in need of a better dimensional stability. They are easily distinguishable by their surface, in the case of PE-HD / E, it presents the different faces (1 matte and 1 glossy). In the case of PE-HD / P, the faces are the same with rectified appearance.



## MAIN CHARACTERISTICS

- Good chemical resistance, wear and abrasion resistance
- Good resistance to impact even at low temperatures
- Low water absorption
- Mechanical resistance and moderate deformation
- Very good dielectric properties and good electrical insulation (except for the static dissipative qualities)
- Easy machining
- Physiologically inert, it enables food contact
- Good resistance to high energy radiation (gamma rays and X-rays)
- It is not self-extinguishing

## APPLICATIONS

- Cutting boards for working tables of food industry
- Elements for water drainage
- Parts of pumps in contact with aggressive products
- All types of mechanical, chemical and electrical applications



CHEMICAL RESISTANCE



ELECTRICAL INSULATION



WEAR RESISTANCE



SLIDING PROPERTIES



IMPACT RESISTANCE

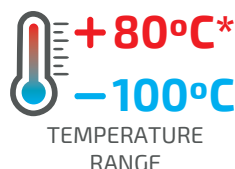

TEMPERATURE RANGE

\*continuously (20.000H)



PLATES

THICKNESS (mm)	PE-HD								
	KG/PIECE <sup>(1)</sup>	WHITE	BLACK	GREEN	RED	YELLOW	BLUE	DARK RED	MULTICOLOR
Standard size 1000 x 2000 mm									
1	2.00	● (E)	● (E)	○ (E)	○ (E)	○ (E)	○ (E)	○ (E)	-
2	4.00	● (E)	● (E)	● (E)	◐ (E)	◐ (E)	◐ (E)	○ (E)	-
3	6.00	● (E)	● (E)	● (E)	◐ (E)	◐ (E)	◐ (E)	○ (E)	-
4	8.00	● (E)	● (E)	● (E)	◐ (E)	◐ (E)	◐ (E)	○ (E)	-
5	10.00	● (E)	● (E)	● (E)	◐ (E)	◐ (E)	◐ (E)	○ (E)	-
6	12.00	● (E)	● (E)	● (E)	◐ (E)	◐ (E)	◐ (E)	○ (E)	-
8	16.00	● (E)	● (E)	● (E)	● (E)	● (E)	◐ (E)	○ (E)	-
10	20.00	● (E)	● (E) (P)	● (E) (P)	● (E)	● (E)	● (E)	● (E)	-
12	24.00	● (E)	● (E) (P)	● (E) (P)	◐ (E)	◐ (E)	● (E)	○ (E)	-
15	30.00	● (E)	● (E) (P)	● (E)	● (E)	● (E)	● (E)	● (E)	-
20	40.00	● (E) (P)	● (E) (P)	● (E) (P)	● (E)	● (E)	● (E)	● (E)	● (P)
25	50.00	● (E) (P)	● (E) (P)	● (E) (P)	● (E) (P)	● (E)	● (E)	● (E)	-
30	60.00	● (E) (P)	● (E) (P)	● (E) (P)	● (E)	● (E)	● (E)	● (E)	● (P)
35	70.00	● (P)	● (P)	● (P)	○ (E)	○ (E)	○ (E)	○ (E)	-
40	80.00	● (E) (P)	● (P)	● (P)	○ (E)	● (E)	● (E) (P)	● (E) (P)	-
45	90.00	● (P)	● (P)	○ (P)	○ (P)	○ (P)	○ (P)	○ (P)	-
50	100.00	● (P)	● (P)	● (P)	○ (P)	● (E)	◐ (E) (P)	● (E) (P)	-
60	120.00	● (P)	● (P)	● (P)	○ (P)	○ (P)	● (P)	● (P)	● (P)
70	140.00	○ (P)	○ (P)	○ (P)	○ (P)	○ (P)	○ (P)	○ (P)	● (P)
80	160.00	● (P)	● (P)	● (P)	○ (P)	○ (P)	○ (P)	● (P)	-
90	180.00	○ (P)	○ (P)	○ (P)	○ (P)	○ (P)	○ (P)	○ (P)	-
100	200.00	● (P)	● (P)	○ (P)	● (P)	○ (P)	● (P)	● (P)	-
Standard size 2050 x 3050 mm									
5	31.25	● (E)	○ (E)	○ (E)	○ (E)	○ (E)	○ (E)	○ (E)	-
6	37.51	● (E)	○ (E)	○ (E)	○ (E)	○ (E)	○ (E)	○ (E)	-
8	50.00	● (E)	● (E)	○ (E)	● (E)	● (E)	◐ (E)	○ (E)	-
10	62.52	● (E)	● (E) (P)	● (E)	○ (E)	● (E)	● (E)	● (E)	-
12	75.00	● (E)	● (E) (P)	● (E) (P)	○ (E)	○ (E)	○ (E)	○ (E)	-
15	93.80	● (E)	● (E) (P)	● (E) (P)	○ (E)	○ (E)	○ (E)	○ (E)	-
20	125.00	● (E) (P)	● (E) (P)	● (E) (P)	○ (E)	○ (E)	○ (E)	● (E)	-
25	156.30	● (E) (P)	● (E) (P)	● (E) (P)	● (E)	○ (E)	● (E)	● (E)	-
30	187.57	● (E) (P)	● (E) (P)	● (E) (P)	● (E)	○ (E)	● (E)	● (E)	-
35	218.84	● (P)	● (P)	● (P)	○ (E)	○ (E)	○ (E)	○ (E)	-
40	250.10	● (P)	● (P)	● (P)	○ (E)	○ (E)	○ (P)	● (E) (P)	-
45	281.36	● (P)	● (P)	○ (P)	○ (P)	○ (P)	○ (P)	○ (P)	-
50	312.60	● (P)	● (P)	● (P)	● (P)	○ (E) (P)	○ (P)	● (P)	-
60	375.15	● (P)	● (P)	● (P)	● (P)	○ (P)	● (P)	● (P)	-
70	437.68	○ (P)	○ (P)	○ (P)	○ (P)	○ (P)	○ (P)	○ (P)	-
80	500.20	● (P)	● (P)	● (P)	◐ (P)	○ (P)	○ (P)	● (P)	-
90	562.73	○ (P)	○ (P)	○ (P)	○ (P)	○ (P)	○ (P)	○ (P)	-
100	625.25	● (P)	● (P)	○ (P)	● (P)	○ (P)	○ (P)	● (P)	-

(E) Extruded

(P) Pressed

(1): average production weights

● Standard; generally available from stock  
 ◐ Semi-standard; generally not available from stock  
 ○ Non-standard; generally not available from stock, manufactured to order and subject to special conditions





### ROUND RODS

DIAMETERS (mm)	PE-HD		
	KG/PIECE <sup>(1)</sup>	WHITE	BLACK
Standard length 2000 mm			
10	0.16	●	●
12	0.24	●	○
15	0.36	●	●
20	0.65	●	●
25	1.01	●	●
30	1.40	●	●
35	1.90	●	●
40	2.50	●	●
45	3.20	●	●
50	3.90	●	●
55	4.80	●	●
60	5.70	●	●
65	6.60	●	●
70	7.70	●	●
80	10.10	●	●
90	12.70	●	●
100	16.36	●	●
110	19.36	●	●
120	22.88	●	●
130	26.64	●	●
Standard length 1000 mm			
140	15.58	●	●
150	18.00	●	●
160	20.60	●	●
180	25.70	●	●
200	34.00	●	●
225	42.10	●	○
250	50.93	●	○
300	74.00	●	○

(1): average production weights

**THINKING OF YOU, WE CUT THE MATERIALS TO YOUR MEASURE!**



- Standard: generally available from stock
- ◐ Semi-standard: generally not available from stock
- Non-standard: generally not available from stock, manufactured to order and subject to special conditions

**Semi-crystalline plastic**, this grade of PE-UHMW with an extremely high percentage of polymerization, contains MoS<sub>2</sub> (molybdenum disulphide) resulting in a material with improved wear resistance and sliding properties above TIVAR® 1000. The coefficient of friction decreases with increasing contact pressure. TIVAR® TECH is used in applications with heavy loads and where dry work is required

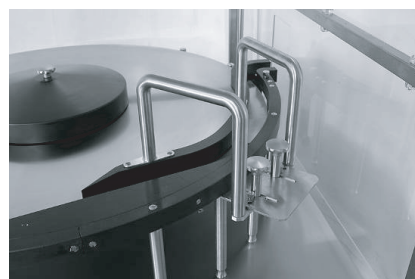

### MAIN CHARACTERISTICS

- ◆ Self-lubricating
- ◆ Very low coefficient of friction
- ◆ High resistance to wear
- ◆ High resistance to impact
- ◆ Excellent chemical resistance
- ◆ Very good noise and shock absorption
- ◆ It does not absorb moisture
- ◆ Good sliding properties

### APPLICATIONS

- ◆ Reels for chains and gear discs
- ◆ Sliding components
- ◆ Cable traction car bushings
- ◆ Roller guides
- ◆ Sliding components for ski lifts and cable cars
- ◆ Sprockets



CHEMICAL RESISTANCE



ELECTRICAL INSULATION



WEAR RESISTANCE



SLIDING PROPERTIES



IMPACT AO RESISTANCE

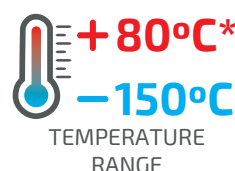

\*continuously (20.000H)

All figures given are indicative only, Polylanema Lda. is not liable for the use of the materials without consulting with our technical department.



PE ●

# TIVAR® CERAM P

**Semi-crystalline plastic**, TIVAR® CERAM P is an extremely wear-resistant material. It has excellent properties for very specific resistance and abrasion requirements. Developed specifically for the papermaking industry. It is a material with a longer life, especially in applications of high loads (high loads, high speeds).

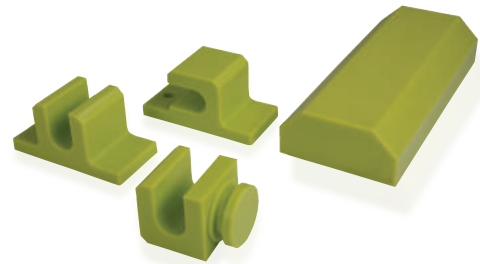

## MAIN CHARACTERISTICS

- Very good resistance to abrasion when subjected to high loads and speeds
- Good sliding properties
- High resistance to impact
- Very good chemical resistance
- Noise reduction
- Self-lubricating
- Resistant to corrosion
- It does not absorb moisture
- High tensile strength

## APPLICATIONS

- Chain Profiles and Curbs
- Guides in the filling and packaging industries
- Sliding components aimed at the transmission and transportation industries
- Components in the pulp and paper industries: cleaning strips, vacuum plates, wear parts, suction box blades and tops, sealing strips
- Conveyor components: bearings, belt guides, chain guides, wear strips
- Telescopic boom guides



CHEMICAL RESISTANCE



ELECTRICAL INSULATION



WEAR RESISTANCE



SLIDING PROPERTIES



IMPACT RESISTANCE

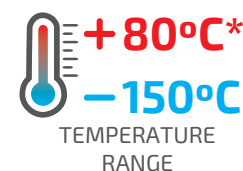

TEMPERATURE RANGE

\*continuously (20.000H)

**Semi-crystalline plastic**, TIVAR® DS is a modified high molecular weight PE-UHMW. This, in combination with a particular manufacturing process, results in a quality of PE-UHMW with superior wear and abrasion resistance compared to TIVAR® 1000.

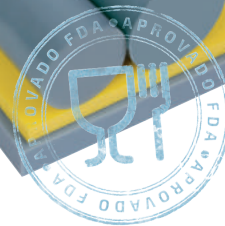

## MAIN CHARACTERISTICS

- Internal lubrication for increased abrasion and wear resistance
- Good sliding properties
- Good impact resistance even at temperatures below 200°

## APPLICATIONS

- Manufacturing of mechanical parts in general
- Machinery for bottling, canning and packaging
- Chemical and galvanizing industry
- Cryogenic equipment
- Textile industry
- Bottling lines
- Chemical and galvanizing industry
- Chain guides
- Stars and curbs
- Conveyor spindles



CHEMICAL  
RESISTANCE



ELECTRICAL  
INSULATION



WEAR  
RESISTANCE



SLIDING  
PROPERTIES



IMPACT  
AO RESISTANCE

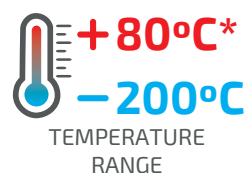

\*continuously (20.000H)

All figures given are indicative only, Polylanema Lda. is not liable for the use of the materials without consulting with our technical department.



PE ○

# TIVAR® H.O.T

**Semi-crystalline plastic**, IVAR® H.O.T (Higher Operating Temperature) has been formulated to maintain its performance when exposed to a wide range of temperatures (80 ° - 135 ° C depending on the load). Special additives reduce the oxidation rate of this material at high temperatures, consequently slowing down its degradation and extending its life time. It is suitable for conveyor systems or other equipment which are often exposed to chemical washes (meat processing and packaging industries), spiral conveyors in the baking industry or wear profiles for drying systems.



## MAIN CHARACTERISTICS

- Increased resistance over a wide range of temperatures (80° C to 135° C depending on load)
- Contains additives that inhibit oxidation
- Low coefficient of friction
- Good resistance to corrosion and moisture
- High resistance to abrasion and wear
- Very good chemical resistance

## APPLICATIONS

- Guide skirts and wear guides
- Worm screws
- Segments, stars, curves and profiles
- Strips and wear plates on conveyors and drying units
- Coatings for feeders of raw materials in the food and fertilizer industry
- Seals
- Chain guides
- Conveyor components



CHEMICAL RESISTANCE



ELECTRICAL INSULATION



WEAR RESISTANCE



SLIDING PROPERTIES



IMPACT RESISTANCE



TEMPERATURE RANGE

\*continuously (20.000H)



**Semi-crystalline plastic,** TIVAR® SUPERPLUS is an optimized PE-UHMW material for use in extremely demanding applications and environments (high loads, high speeds and abrasive environments).

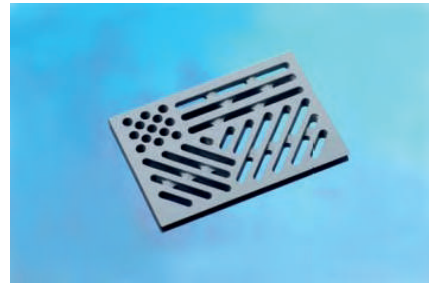

## MAIN CHARACTERISTICS

- Extreme resistance to abrasion and wear
- Very good sliding properties
- Good dimensional stability
- Reduced thermal expansion
- Excellent chemical resistance

## APPLICATIONS

- Guides and sliding components used in the transmission and transportation industries
- Guide skirts and profiles used in the filling and packaging industries
- Demanding applications in the pulp industry



CHEMICAL RESISTANCE



ELECTRICAL INSULATION



WEAR RESISTANCE



SLIDING PROPERTIES



IMPACT AO RESISTANCE

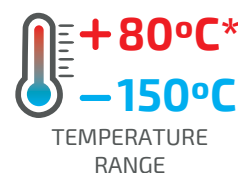

\*continuously (20.000H)





PE ● ○ ●

# TIVAR® 1000

**Semi-crystalline plastic,** TIVAR® 1000 is an engineering PE-UHMW, with an approximate molecular weight of 5 million g/mol. In the range of ultra-high molecular weight polyethylene, TIVAR® 1000 offers a better balance of its properties. It combines excellent wear and abrasion resistance with exceptional impact resistance, even at temperatures below -200° C.



## MAIN CHARACTERISTICS

- High resistance to wear and abrasion
- Excellent chemical resistance
- High resistance to impact
- Low density (when compared with other thermoplastics)
- Low coefficient of friction and very low water absorption
- Very good dielectric properties and very good electrical insulation
- Good resistance to high energy radiation (gamma rays and X-rays)
- Excellent machining

## APPLICATIONS

- Bottling machinery
- Canning and packaging industries
- Chemical and galvanizing industry
- Cryogenic equipment
- Manufacturing of parts and components in general
- Conveyor spindles
- Textile industry
- Storage and transport equipment
- Parts for pumps
- Chain guides
- Stars and curves
- Coating of silos



CHEMICAL RESISTANCE



ELECTRICAL INSULATION



WEAR RESISTANCE



SLIDING PROPERTIES



IMPACT RESISTANCE

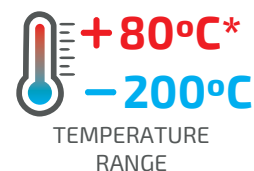

TEMPERATURE RANGE

\*continuously (20.000H)



**Semi-crystalline plastic**, TIVAR® 1000 EC is a polyethylene containing specific additives, giving this material a lower surface resistivity than TIVAR® 1000 ESd, which in turn improves the electrical conductivity and resistance to UV rays.

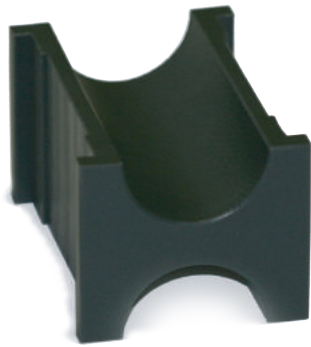

## MAIN CHARACTERISTICS

- Electro conductive material
- Self-lubricating
- Very low coefficient of friction
- High resistance to wear
- High resistance to impact
- Excellent chemical resistance
- Very good noise and shock absorption
- It does not absorb moisture
- Good sliding properties

## APPLICATIONS

- Reels for chains and gear discs
- Sliding components
- Cable traction car bushings
- Roller guides
- Sliding components for ski lifts and cable cars
- Sprockets
- In general, all applications where electro conductive material is required



CHEMICAL  
RESISTANCE



ELECTRICAL  
INSULATION



WEAR  
RESISTANCE



SLIDING  
PROPERTIES



IMPACT  
AO RESISTANCE

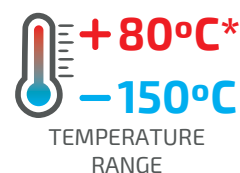

\*at 20.000H



PE ● ○ ●

# TIVAR® 1000 TG1

**Semi-crystalline plastic,** TIVAR® 1000 TG1 is a material with a molecular weight of 9 million g/mol, extremely high compared to TIVAR® 1000 (5 million g/mol), which results in a quality of PE-UHMW with resistance to wear and abrasion compared to TIVAR® 1000.

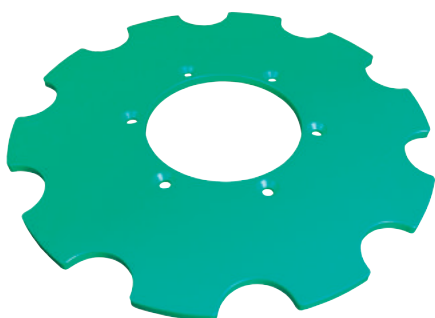
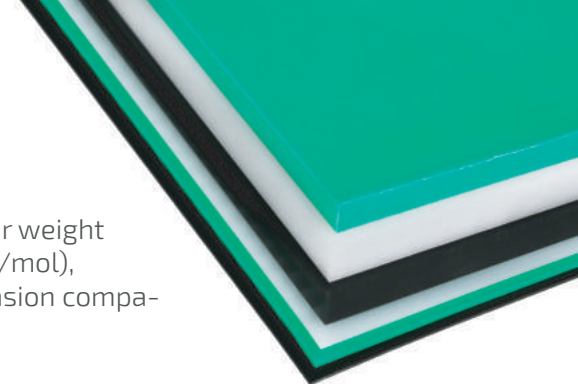

## MAIN CHARACTERISTICS

- Molecular Weight 9,000,000 g/mol
- High wear and abrasion resistance (better than TIVAR® 1000)
- High resistance to impact
- Low coefficient of friction
- Excellent machining

## APPLICATIONS

- Suitable for the same applications as the TIVAR® 1000 with better performances.
- Sliding guides and profiles



CHEMICAL RESISTANCE



ELECTRICAL INSULATION



WEAR RESISTANCE



SLIDING PROPERTIES



IMPACT RESISTANCE

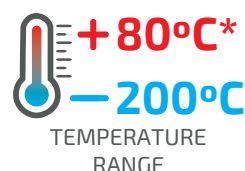

\*continuously (20.000H)

DELIVERY PROGRAM AVAILABLE ON REQUEST

132 | [www.polylanema.pt](http://www.polylanema.pt)

All figures given are indicative only. Poly Lanema Lda. is not liable for the use of the materials without consulting with our technical department.

# TIVAR® 1000 ANTISTATIC



**Semi-crystalline plastic**, which through carbon incorporation, offers the static dissipative properties often required for PE-UHMW components, working on high speed lines and containers, while keeping the inherent key characteristics. The material supports conditions where dust and static electricity can cause problems. TIVAR® 1000 ANTISTATIC is the ideal material for unstable conditions such as elevators, ore and grain conveyors, and the ammunition industry, effectively protecting against static discharges.

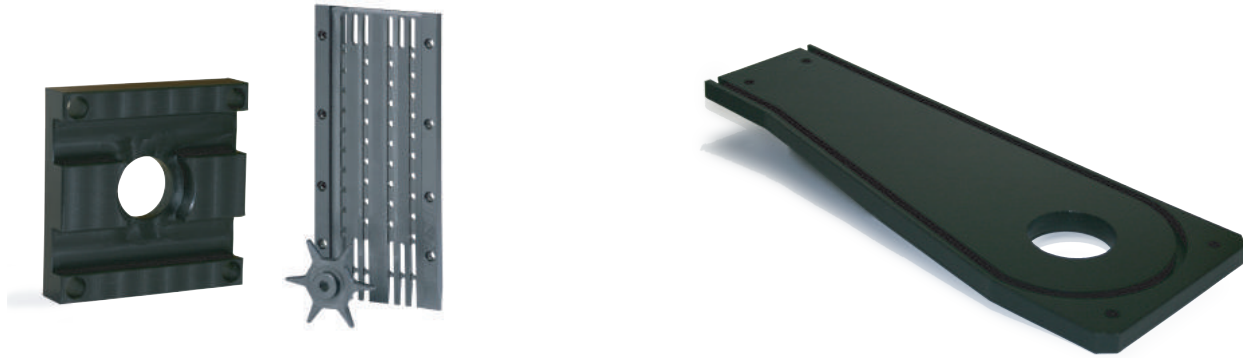

## MAIN CHARACTERISTICS

- Anti-static
- High resistance to wear and abrasion
- Excellent chemical resistance
- High resistance to impact
- Low density (when compared with other thermo-plastics)
- Low coefficient of friction and very low water absorption
- Very good dielectric properties and very good electrical insulation
- Good resistance to high energy radiation (gamma rays and X-rays)
- Excellent machining

## APPLICATIONS

- Conveyor components
- Bearings
- Chain guides
- Rail/guide coating
- Discharge pipe coating
- Guide rails
- Slides
- Robotic parts
- Platform Surfaces
- Transfer boards
- Wear guides

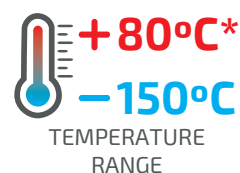
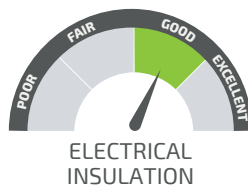

\*continuously (20.000H)



PE ●

# TIVAR® 1000 ASTL

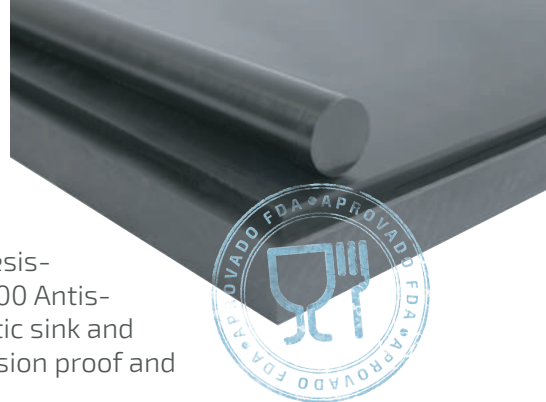

**Semi-crystalline plastic**, TIVAR® 1000 ASTL has been specifically developed for the most demanding anti-abrasive applications, having a higher resistance to wear and abrasion and a lower surface resistivity than TIVAR® 1000 Antistatic. The additives used give this material the property of becoming a static sink and high UV resistance, providing protection against ageing. It is also an explosion proof and non-toxic material.



## MAIN CHARACTERISTICS

- Anti-static
- High resistance to UV rays
- High resistance to abrasion
- Physiologically inert
- Low coefficient of friction
- Without internal stresses
- Easy machining

## APPLICATIONS

- Oil Industry
- Applications where there is a risk of explosion
- Outdoor applications
- More demanding abrasive applications



CHEMICAL RESISTANCE



ELECTRICAL INSULATION



WEAR RESISTANCE



SLIDING PROPERTIES



IMPACT RESISTANCE

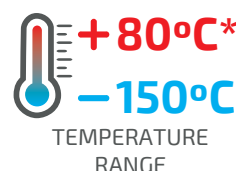

\*continuously (20.000H)

**Semi-crystalline plastic**, that thanks to the lubricant and the highest molecular weight is the material that offers the lowest coefficient of friction of the TIVAR® family and better resistance to wear and abrasion than TIVAR® 1000. The low coefficient of friction and its antistatic properties make TIVAR® DRYSLIDE an excellent material in harsh environments. The additives used also considerably improve the UV resistance.

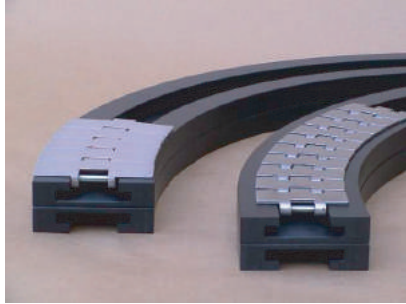

## MAIN CHARACTERISTICS

- Self-lubricating
- Extremely low coefficient of friction
- Excellent noise reduction
- Very high resistance to wear
- High resistance to impact
- Good chemical resistance
- UV resistance
- It does not absorb moisture
- Electro-static heatsinks
- Ideal for dusty environments
- Resistant to corrosion
- Anti-static

## APPLICATIONS

- Curbs and guides for side chains
- Slide plates for conveyor belts
- High speed chain guides
- Guides for flat and trapezoidal belts at high speeds
- Sliding ramps
- Transmission and slip components
- Sliding components in elevators
- Bypass Bars
- Guide rollers and roller covers

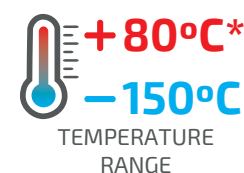
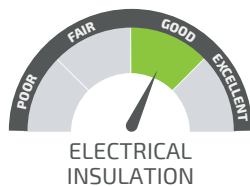

\*continuously (20.000H)

All figures given are indicative only, Polyanema Lda. is not liable for the use of the materials without consulting with our technical department.





PE ●

# TIVAR® QuickSilver

**Semi-crystalline plastic**, QuickSilver coatings extend the service life of any truck. They protect the aluminium and allow more payloads than steel. They are designed for discharges of difficult materials, including hot asphalt in the worst conditions. QuickSilver coatings release a sticky substance, which means faster discharge, less damage to the equipment, less wear on hoists, minimal cleaning and reduced downtime.

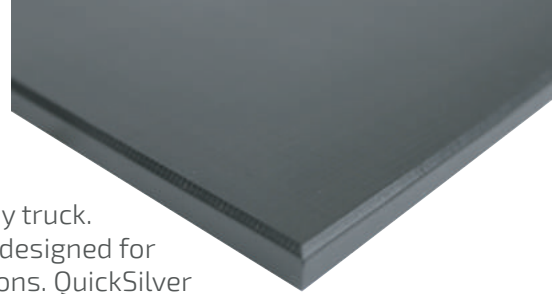

## MAIN CHARACTERISTICS

- Resistant to abrasion, corrosion and chemicals
- High resistance to impact
- Better than traditional materials
- Weighs less than aluminium or steel
- Better non-stick properties
- Provides complete and constant discharge
- No freezing
- Safe even on uneven ground
- No means of separation and purification required

## APPLICATIONS

- Coating of cargo trucks. Effective in all type of raw material such as: stone, rubble, gravel, crushed stone, earth, sand, sludge (sewage), surface soil, clay, coal, limestone, gypsum, salts, ores, ashes, grains, fertilizers, among others

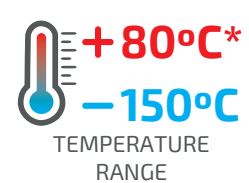
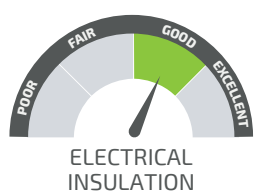

\*continuously (20.000H)

DELIVERY PROGRAM AVAILABLE ON REQUEST

All figures given are indicative only, Polylanema Lda. is not liable for the use of the materials without consulting with our technical department.

**Semi-crystalline plastic**, TIVAR® 88 is a dark blue polymer-based material that has been optimized to be used as a coating material. Due to its excellent properties (low coefficient of friction and excellent resistance to wear), TIVAR® 88 is the recommended material for the coating of storage and transport containers. Continuous quality control ensures a high level of quality. Due to the constant properties of the material, TIVAR® 88 offers reliable quality, also for maintenance work.

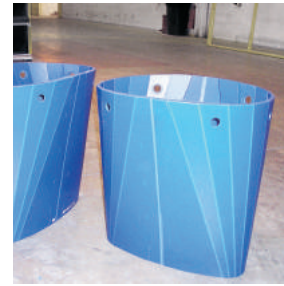
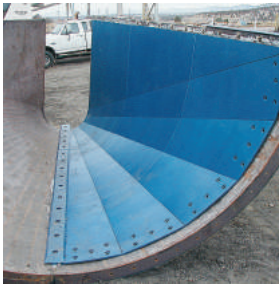

## MAIN CHARACTERISTICS

- High chemical resistance and to abrasion
- High resistance to wear
- Resistant to abrasion
- Low coefficient of friction
- No moisture absorption
- Reduces or eliminates warping and erratic flow
- Electro-static heatsinks
- UV resistant
- Sliding surface for any kind of bulk material

## APPLICATIONS

- Rail coating
- Silo coating
- Storage and shipping container coating
- Food hopper coating
- Railway wagons coating and any type of bulk material handling equipment



CHEMICAL  
RESISTANCE



ELECTRICAL  
INSULATION



WEAR  
RESISTANCE



SLIDING  
PROPERTIES



IMPACT  
AO RESISTANCE

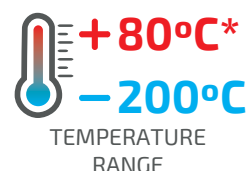

\*continuously (20.000H)

All figures given are indicative only, Polyanema Lda. is not liable for the use of the materials without consulting with our technical department.

DELIVERY PROGRAM AVAILABLE ON REQUEST

www.polyanema.pt | 137



### SHEETS

THICKNESS (mm)	TOLERANCES (mm)		TIVAR® H.O.T		TIVAR® DRYSLIDE	
			KG/PIECE <sup>(1)</sup>	STOCK	KG/PIECE <sup>(1)</sup>	STOCK
Standard size 1220 x 3000 mm <sup>(2)</sup>						
2	-0.2	+0.2	7.75	○	7.75	○
3			10.57	○	10.60	○
4			14.10	○	14.10	○
5			17.60	●	17.60	○
6	-0.3	+0.3	21.13	○	21.00	●
8			-	-	-	-

Sheets of other qualities available on request and subject to special conditions  
Other sheet sizes available on request and subject to special conditions  
(1): average production weights  
(2): tolerances in width -0.0 / + 10.0 mm; in length -0.0 / + 30.0 mm

### SHEETS

THICKNESS (mm)	TOLERANCES (mm)		TIVAR® DS		TIVAR® CERAM P		TIVAR® H.O.T	
			KG/PIECE <sup>(1)</sup>	GREY	KG/PIECE <sup>(1)</sup>	STOCK	KG/PIECE <sup>(1)</sup>	STOCK
Standard size 1000 x 2000 mm <sup>(2)</sup>								
1	0.0	+0.4	2.31	○	2.37	○	2.31	○
2	-0.2	+0.2	3.80	○	3.95	○	3.84	○
3			5.80	●	5.92	○	5.80	○
4			7.70	○	7.89	○	7.70	○
5			9.60	●	9.87	○	9.60	○
6	-0.3	+0.3	11.50	○	11.80	○	11.50	○

Sheets of other qualities available on request and subject to special conditions  
Other plate sizes available on request and subject to special conditions  
(1): average production weights  
(2): tolerances in width -0.0 / + 10.0 mm; in length -0.0 / + 10.0 mm

### SHEETS

THICKNESS (mm)	TOLERANCES (mm)		TIVAR® TECH		TIVAR® 1000		TIVAR® 1000 ANTISTATIC		TIVAR® 1000 EC		TIVAR® DRYSLIDE		
			KG/PIECE <sup>(1)</sup>	STOCK	KG/PIECE <sup>(2)</sup>	WHITE	GREEN	KG/PIECE <sup>(1)</sup>	STOCK	KG/PIECE <sup>(1)</sup>	STOCK	KG/PIECE <sup>(1)</sup>	STOCK
Standard size 1000 x 2000 mm <sup>(2)</sup>													
1	0.0	+0.4	2.31	○	2.30	●	●	2.30	●	2.34	○	2.31	○
2	-0.2	+0.2	3.84	○	3.80	●	●	3.80	●	3.91	○	3.84	○
3			5.80	○	5.80	●	●	5.80	●	5.86	○	5.77	○
4			7.70	○	7.70	●	●	7.70	●	7.80	○	7.69	○
5			9.61	○	9.60	●	●	9.60	●	9.76	○	9.61	○
6	-0.3	+0.3	11.50	○	11.50	●	●	11.50	●	11.72	○	11.53	○
8			-	-	15.40	●	●	15.40	●	15.97	○	-	-

Tivar® 1000 sheets, other colors available on request and subject to special conditions  
Other plate sizes available on request and subject to special conditions  
(1): average production weights  
(2): tolerances in width -0.0 / + 10.0 mm; in length -0.0 / + 10.0 mm

- Standard: generally available from stock
- Semi-standard: generally not available from stock
- Non-standard: generally not available from stock, manufactured to order and subject to special conditions

## PLATES

THICKNESS (mm)	TOLERANCES (mm)		TIVAR® DS		TIVAR® CERAM P		TIVAR® H.O.T		TIVAR® SUPERPLUS	
			KG/PIECE <sup>(1)</sup>	GREY	KG/PIECE <sup>(1)</sup>	STOCK	KG/PIECE <sup>(1)</sup>	STOCK	KG/PIECE <sup>(1)</sup>	STOCK
Standard size 1220 x 3050 mm <sup>(2)</sup>										
8	-0.2	+0.2	29.70	●	30.50	○	29.70	●	-	-
10	0.0	+0.4	37.00	●	38.00	●	37.00	●	37.99	○
12			44.26	●	45.40	○	44.26	○	45.44	○
15			55.10	●	56.60	●	55.14	●	56.62	○
20			73.30	●	75.20	●	73.30	●	75.24	○
25			91.42	●	93.90	●	91.42	○	93.86	○
30			109.60	●	112.50	●	109.60	●	112.49	○
35			127.70	○	131.10	○	127.69	○	131.11	○
40			145.80	●	149.73	●	145.83	○	149.73	○
45			164.00	○	168.36	○	163.97	○	168.36	○
50			182.10	●	186.998	●	182.11	○	186.98	○
60	218.40	○	224.23	○	218.39	○	224.23	○		
70	254.66	●	261.47	○	254.66	○	261.47	○		
80	0.0	+0.6	291.30	●	299.09	○	291.30	○	299.09	○
90			327.58	○	336.34	○	327.58	○	336.34	○
100			363.86	●	373.59	○	363.86	○	373.59	○

Tivar® DS (yellow) plates available on request and subject to special conditions  
 Other plate sizes available on request and subject to special conditions  
 (1): average production weights  
 (2): tolerances in width -0.0 / + 30.0 mm; in length -0.0 / + 60.0 mm

## PLATES

THICKNESS (mm)	TOLERANCES (mm)		TIVAR® TECH		TIVAR® 1000			TIVAR® 1000 ANTISTATIC		TIVAR® 1000 EC		TIVAR® DRYSLIDE		
			KG/PIECE <sup>(1)</sup>	STOCK	KG/PIECE <sup>(2)</sup>	WHITE	GREEN	BLACK	KG/PIECE <sup>(1)</sup>	STOCK	KG/PIECE <sup>(1)</sup>	STOCK	KG/PIECE <sup>(1)</sup>	STOCK
Standard size 1220 x 3050 mm <sup>(2)</sup>														
8	0.0	+0.4	29.70	●	29.80	●	●	●	-	-	-	-	29.70	●
10			37.00	●	37.00	●	●	●	37.00	●	37.60	○	37.00	●
12			44.30	●	44.30	●	●	●	44.30	●	44.97	○	55.10	○
15			55.10	●	55.10	●	●	●	55.10	●	56.03	○	55.14	○
20			73.30	●	73.30	●	●	●	73.30	●	74.45	○	73.28	○
25			91.40	●	91.40	●	●	●	91.40	●	92.90	○	91.40	●
30			109.60	●	109.60	●	●	●	109.60	●	111.31	○	109.60	●
35			127.70	●	127.70	●	●	○	127.70	○	129.74	○	127.70	○
40			145.83	●	145.80	●	●	●	145.80	○	148.17	○	145.83	○
45			163.97	○	164.00	○	●	○	164.00	○	166.60	○	163.97	○
50	182.10	○	182.10	●	●	●	182.10	○	185.03	○	182.10	○		
60	218.40	○	218.40	●	●	○	218.40	○	221.89	○	218.39	○		
70	254.70	○	254.66	○	○	○	254.70	○	258.75	○	254.66	○		
80	0.0	+0.6	291.30	○	291.30	●	●	○	291.30	●	295.98	○	291.30	○
90			327.58	○	327.60	○	○	○	332.84	○	332.84	○	327.58	○
100			363.86	○	363.90	●	○	○	369.69	●	369.69	○	363.86	○

Tivar® 1000 plates, other colors available on request and subject to special conditions  
 Other plate sizes available on request and subject to special conditions  
 (1): average production weights  
 (2): tolerances in width -0.0 / + 30.0 mm; in length -0.0 / + 60.0 mm

- Standard: generally available from stock
- ◐ Semi-standard: generally not available from stock
- Non-standard: generally not available from stock, manufactured to order and subject to special conditions



### PLATES

THICKNESS (mm)	TOLERANCES (mm)	TIVAR® ASTL					
		KG/PIECE <sup>(1)</sup>	GREY	KG/PIECE <sup>(1)</sup>	STOCK	KG/PIECE <sup>(1)</sup>	STOCK
Standard size		1220 x 2020 mm <sup>(2)</sup>		2050 x 3050 mm		1220 x 3050 mm	
8	0.0 +0.4	20.00	●	-	○	-	○
10		24.90	○	62.30	●	38.00	●
12		29.80	○	74.40	●	-	○
15		37.10	●	94.80	●	-	○
20		49.30	○	122.20	●	-	○
25		61.60	●	156.30	●	-	○
30		73.80	○	183.30	●	-	○
35		86.00	○	-	○	-	○
40		98.20	●	-	○	147.50	●
45		110.42	○	-	○	-	○
50		122.60	○	-	○	-	○
60		147.10	●	-	○	-	○
70		171.50	○	-	○	-	○
80		196.20	○	-	○	-	○
90	0.0 +0.6	220.60	○	-	○	-	○
100		245.00	○	-	○	-	○

(1): average production weights  
(2): tolerances in width -0.0 / + 30.0 mm; in length -0.0 / + 60.0 mm

### ROUND RODS

DIAMETERS (mm)	TOLERANCES (mm)	TIVAR® DS		TIVAR® 1000 ASTL		TIVAR® 1000 ANTISTATIC	
		KG/PIECE <sup>(1)</sup>	GREY	KG/PIECE <sup>(1)</sup>	STOCK	KG/PIECE <sup>(1)</sup>	STOCK
Standard length 1000 mm <sup>(2)</sup>							
20	0.0 +1.0	0.31	●	0.31	●	0.32	○
25		0.48	●	0.48	○	0.49	○
30		0.69	●	0.69	○	0.70	○
35		0.93	●	0.93	○	0.94	○
40		1.21	●	1.22	●	1.23	○
45		1.53	○	1.54	○	1.55	○
50		1.88	●	1.90	○	1.91	○
55		2.27	○	2.29	○	2.31	○
60		2.70	●	2.72	○	2.74	○
70		3.66	●	3.70	●	3.72	○
80		4.77	●	4.82	●	4.85	○
90		6.03	●	6.10	○	6.13	○
100		7.44	●	7.52	●	7.56	○
110		8.99	●	9.09	○	9.13	○
120		10.69	●	10.81	○	10.86	○
125		11.60	○	11.71	○	11.78	○
130		12.54	○	12.68	○	12.74	○
140		14.53	●	14.70	●	14.77	○
150	16.68	●	16.87	○	16.94	○	
160	18.97	○	19.18	○	19.27	○	
170	21.40	○	21.67	○	21.74	○	
180	23.99	●	24.29	○	24.37	○	
190	0.0 +0.4	26.72	○	27.06	○	27.14	○
200		29.60	●	29.94	●	30.07	○
210		32.62	○	33.06	○	33.14	○
220		35.79	○	36.28	○	36.37	○
230		39.11	○	39.65	○	39.74	○
240		42.58	○	43.18	○	43.26	○

(1): average production weights  
(2): tolerances in length -0.0 / + 60.0 mm

- Standard: generally available from stock
- ◐ Semi-standard: generally not available from stock
- Non-standard: generally not available from stock, manufactured to order and subject to special conditions

## ROUND RODS (EXTRUDED)

DIAMETERS (mm)	TOLERANCES (mm)		TIVAR® 1000			
			KG/PIECE <sup>(2)</sup>	WHITE	BLACK	GREEN
Standard length 2000 mm <sup>(2)</sup>						
10	+0.2	+0.7	0.08	●	○	◐
15	+0.2	+0.8	0.35	●	○	○
20	+0.2	+1.0	0.63	●	●	◐
25	+0.2	+1.1	1.00	●	●	◐
30	+0.2	+1.2	1.40	●	●	◐
35	+0.2	+1.3	1.90	◐	●	◐
40	+0.2	+1.5	2.50	●	●	◐
45	+0.3	+1.7	3.20	◐	●	○
50	+0.3	+2.0	3.90	●	●	◐
55			4.80	●	●	○
60	+0.3	+2.3	5.70	●	●	◐
65	+0.3	+2.5	6.60	○	○	○
70			7.70	●	●	◐
75			8.90	○	○	○
80	+0.4	+3.0	10.10	●	●	◐
85	+0.5	+3.4	11.40	○	○	○
90			12.70	●	●	◐
100	+0.6	+3.8	15.70	●	●	◐
110	+0.7	+4.2	19.00	●	●	◐
120	+0.8	+4.6	22.70	●	●	◐
125			24.60	●	○	○
130	+0.9	+5.4	26.60	●	●	◐
140			30.80	●	●	◐
150	+1.0	+5.8	35.40	●	●	○
160	+1.1	+6.3	40.30	●	◐	◐
180	+1.2	+7.4	51.00	●	◐	◐
200	+1.3	+8.5	63.00	●	●	◐

Other measures available on request and under special conditions.  
 (1): average production weights  
 (2): tolerances in length -0.0 / + 60.0 mm



SPECIFIC EQUIPMENT TO  
ENSURE **CUTTING INTEGRITY!**

- Standard: generally available from stock
- ◐ Semi-standard: generally not available from stock
- Non-standard: generally not available from stock, manufactured to order and subject to special conditions





# PE TECHNICAL DATASHEET

PROPERTIES	TEST METHODS	UNITS	PE-HD	TIVAR® TECH	TIVAR® CESTIDUR/DS	TIVAR® CERAM P	TIVAR® H.O.T	TIVAR® SUPERPLUS
COLOR		-	WHITE/BLACK GREEN/OTHERS	GREY-BLACK	GREY/YELLOW	YELLOW-GREEN	WHITE	GREY
DENSITY	ISO 1183-1	g/cm <sup>3</sup>	0.96	0.935	0.93	0.96	0.93	0.96
MOLECULAR WEIGHT	-	10 <sup>6</sup> g/mol	0.5	9	9	9	9	9
WATER ABSORPTION AT SATURATION IN WATER OF 23°C <sup>1</sup>	-	%	<0.1	< 0.1	<0.1	<0.1	< 0.1	< 0.1
<b>THERMAL PROPERTIES<sup>2</sup></b>								
MELTING TEMPERATURE (DSC, 10°C/MIN)	ISO 11357-1/-3	°C	135	135	135	135	135	135
THERMAL CONDUCTIVITY AT 23°C	-	W/(K.m)	0.40	0.40	0.40	0.40	0.40	0.40
COEFFICIENT OF LINEAR THERMAL EXPANSION								
BETWEEN 23-100°C	-	M/(m.K)	150 x 10 <sup>-6</sup>	200 x 10 <sup>-6</sup>	200 x 10 <sup>-6</sup>	200 x 10 <sup>-6</sup>	200 x 10 <sup>-6</sup>	180 x 10 <sup>-6</sup>
MAXIMUM ALLOWABLE SERVICE TEMPERATURE IN AIR FOR SHORT PERIODS <sup>3</sup>	-	°C	120	120	120	120	135	120
CONTINUOUSLY: FOR 20.000H <sup>4</sup>		°C	80	80	80	80	110	80
MINIMUM SERVICE TEMPERATURE <sup>5</sup>	-	°C	-100	-150	-200	-150	-200	-150
TEMPERATURE OF DEFLECTION UNDER LOAD								
METHOD A: 1.8 MPa	ISO 75-1/-2	°C	44	42	42	42	42	42
VICAT SOFTENING TEMPERATURE - VST/B50	ISO 306	°C	80	80	80	80	80	80
FLAMMABILITY <sup>6</sup>	-							
"OXYGEN INDEX" ACCORDING TO UL94 (6MM DE ESPESSURA)	ISO 4589-1/-2	%	<20	<20	<20	<20	<20	<20
	-	-	HB	HB	HB	HB	HB	HB
<b>MECHANICAL PROPERTIES AT 23°C<sup>7</sup></b>								
TENSION TEST <sup>8</sup>								
TENSILE STRESS AT YIELD <sup>9</sup>	ISO 527-1/-2	MPa	28	19	19	18	19	17
TENSILE STRAIN AT BREAK	ISO 527-1/-2	%	>50	>50	>50	>50	>50	>50
TENSILE MODULUS OF ELASTICITY <sup>10</sup>	ISO 527-1/-2	MPa	1300	725	700	750	700	600
COMPRESSION TEST <sup>11</sup>								
COMPRESSIVE STRESS AT 1/2/5% NOMINAL STRAIN <sup>10</sup>	ISO 604	MPa	12/13.5/26.5	6.5/10.5/17	6 /10/16	7/11/17.5	6/10/16	5/8.5/14.5
CHARPY IMPACT STRENGTH - UNNOTCHED <sup>12</sup>	ISO 179-1/1eU	KJ/m <sup>2</sup>	NO BREAK	NO BREAK	NO BREAK	NO BREAK	NO BREAK	NO BREAK
CHARPY IMPACT STRENGTH - NOTCHED	ISO 179-1/1eA	KJ/m <sup>2</sup>	105P	105P	100P	105P	100P	90P
CHARPY IMPACT STRENGTH - NOTCHED (DOUBLE 14° NOTCH) <sup>13</sup>	ISO 11542-2	KJ/m <sup>2</sup>	25	120	130	125	130	115
BALL INDENTATION HARDNESS <sup>14</sup>	ISO 2039-1	N/mm <sup>2</sup>	48	32	31	33	31	31
SHORE HARDNESS D (15 S) <sup>14</sup>	ISO 868	-	62	59	58	60	58	58
<b>ELECTRICAL PROPERTIES AT 23°C</b>								
ELECTRIC STRENGTH <sup>15</sup>	IEC 60243-1	kV/mm	45	45	45	45	45	-
VOLUME RESISTIVITY	IEC 60093	Ohm.cm	> 10 <sup>14</sup>	> 10 <sup>14</sup>	> 10 <sup>14</sup>	> 10 <sup>14</sup>	> 10 <sup>14</sup>	> 10 <sup>14</sup>
SURFACE RESISTIVITY	IEC 60093	Ohm	> 10 <sup>12</sup>	> 10 <sup>12</sup>	> 10 <sup>12</sup>	> 10 <sup>12</sup>	> 10 <sup>12</sup>	> 10 <sup>12</sup>
RELATIVE PERMITTIVITY ε <sub>r</sub> : A 100HZ	IEC 60250	-	2.4	-	2.1	-	-	-
RELATIVE PERMITTIVITY ε <sub>r</sub> : A 1MHZ	IEC 60250	-	2.4	-	3.0	-	-	-
DIELECTRIC DISSIPATION FACTOR TAN δ : A 100HZ	IEC 60250	-	0.0002	-	0.0004	-	-	-
DIELECTRIC DISSIPATION FACTOR TAN δ : A 1MHZ	IEC 60250	-	0.0002	-	0.0010	-	-	-
COMPARATIVE TRACKING INDEX (CTI)	IEC 60112	-	600	-	600	-	-	-

NOTE: 1 g/cm<sup>3</sup> = 1000 kg/m<sup>3</sup> ; 1 MPa = 1 N/mm<sup>2</sup> ; 1 KV/mm = 1 MV/m

(1) Measured in 1 mm test pieces. (2) The figures given on these properties are for the most part derived from data from suppliers of raw materials. (3) Only for periods of short exposure (few hours) in applications where only little or no weight is applied to the material. (4) Temperature which it resists for a minimum period of 20,000 hours. After this time, there is a decrease of about 50% in tensile strength compared to the original value. The given temperature values are based on the thermal oxidation degradation which occurs which causes a reduction of the properties. In the meantime, the maximum permissible service temperature depends in many cases essentially on the deduction and magnitude of the mechanical stresses to which the material is subject. (5) As the impact strength decreases with decreasing temperature, the minimum permissible service temperature is determined by the extent of impact to which the material is subjected. The values given are based on unfavorable impact conditions and can not therefore be considered absolute limits. (6) These assessments are derived from the technical specifications of the manufacturers of the raw materials and do not allow the determination of the behavior of the materials under fire conditions. (7) Most of the figures given by the mechanical properties of the extruded materials are mean values of 30 mm-thick plate tests. (8) Testing of test pieces: Type 1B. (9) Speed test: 50 mm / min. (10) Speed test: 1 mm / min. (11) Testing of test pieces: cylinders ø 8x16 mm. (12) Pendulum used: 15J. (13) Pendulum used: 25J. (14) Measured on 10 mm thick test pieces. (15) Electrode configuration: ø 25 / 75mm coaxial cylinders; in transformer oil in accordance with IEC 60296; Test samples 1 mm thick.

# PE TECHNICAL DATASHEET



TIVAR® 1000	TIVAR® 1000 EC	TIVAR® 1000 TG1	TIVAR® 1000 ANTISTATIC	TIVAR® 1000 ASTL	TIVAR® DRYSLIDE	TIVAR® QUICKSILVER	TIVAR® 88
WHITE/BLACK GREEN/OTHERS	BLACK	WHITE/BLACK GREEN/OTHERS	BLACK	BLACK	BLACK	GREY-BLACK	BLUE
0.93	0.945	0.94	0.935	0.95	0.935	0.935	0.93
5	5	9	5	9	9	9	9
< 0.1	< 0.1	< 0.1	< 0.1	< 0.1	< 0.1	< 0.1	< 0.1
135	135	136	135	135	135	135	135
0.40	0.40	0.40	0.40	0.40	0.40	0.40	0.40
200 x 10 <sup>-6</sup>	200 x 10 <sup>-6</sup>	200 x 10 <sup>-6</sup>	200 x 10 <sup>-6</sup>	200 x 10 <sup>-6</sup>	200 x 10 <sup>-6</sup>	200 x 10 <sup>-6</sup>	200 x 10 <sup>-6</sup>
120	120	120	120	120	120	120	90
80	80	80	80	80	80	80	80
-200	-150	-200	-150	-150	-150	-150	-200
42	42	42	42	42	42	42	42
80	82	80	80	82	80	80	80
<20	<20	<20	<20	<20	<20	<20	<20
HB	HB	HB	HB	HB	HB	HB	HB
19	21	19	20	21	18	17	19
>50	>50	>50	>50	>50	>50	>50	>50
750	825	750	790	800	650	575	790
6.5/10.5/17	7.5/12/19	-	7/11/17.5	7/11.5/18	6/10/16	4.5/7.5/13.5	7/10/16
NO BREAK	NO BREAK	NO BREAK	NO BREAK	NO BREAK	NO BREAK	NO BREAK	NO BREAK
115P	105P	-	110P	90P	100P	80P	96
170	110	100	140	80	130	90	-
33	35	33	34	34	32	30	29
60	62	50	61	61	85	58	57
45	-	45	-	-	-	-	-
> 10 <sup>14</sup>	-	> 10 <sup>12</sup>	-	-	-	> 10 <sup>14</sup>	> 10 <sup>12</sup>
> 10 <sup>12</sup>	< 10 <sup>5</sup>	> 10 <sup>12</sup>	< 10 <sup>8</sup>	< 10 <sup>6</sup>	< 10 <sup>8</sup>	> 10 <sup>12</sup>	> 10 <sup>12</sup>
2.1	-	2.1	-	-	-	-	-
3.0	-	3.0	-	-	-	-	-
0.0004	-	0.0004	-	-	-	-	-
0.0010	-	0.0010	-	-	-	-	-
600	-	600	-	-	-	-	-

VERSATILITY AND AVAILABILITY IN THE MANUFACTURING OF **LARGE AND COMPLEX PARTS.**

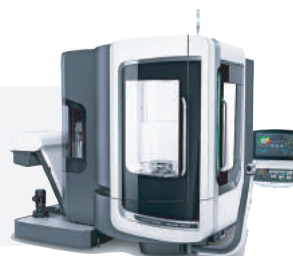



# MAXIMUM ALLOWABLE SERVICE TEMPERATURE IN AIR

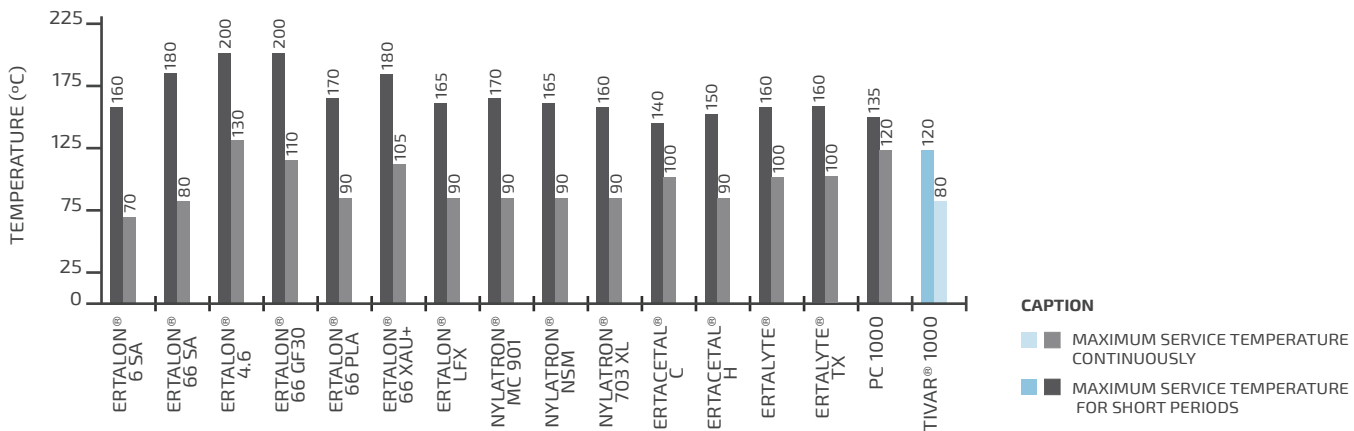

**CAPTION**  
 ■ MAXIMUM SERVICE TEMPERATURE CONTINUOUSLY  
 ■ MAXIMUM SERVICE TEMPERATURE FOR SHORT PERIODS

# RIGIDITY vs. TEMPERATURE

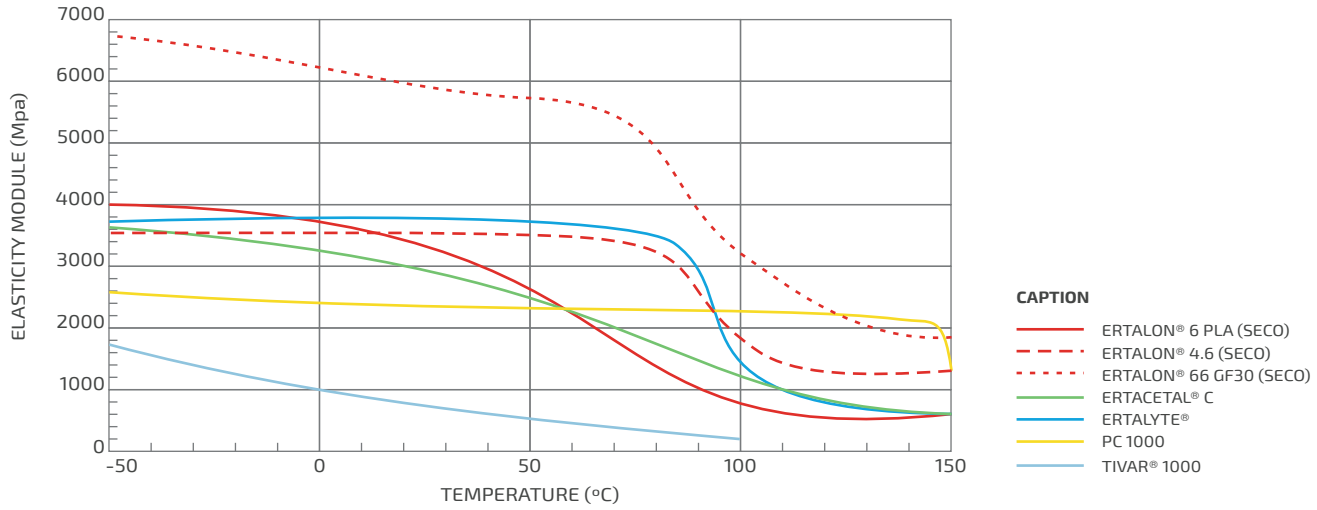

**CAPTION**  
 — ERTALON® 6 PLA (SECO)  
 - - ERTALON® 4,6 (SECO)  
 - - ERTALON® 66 GF30 (SECO)  
 — ERTACETAL® C  
 — ERTALYTE®  
 — PC 1000  
 — TIVAR® 1000

# CHEMICAL RESISTANCE AT 23°C

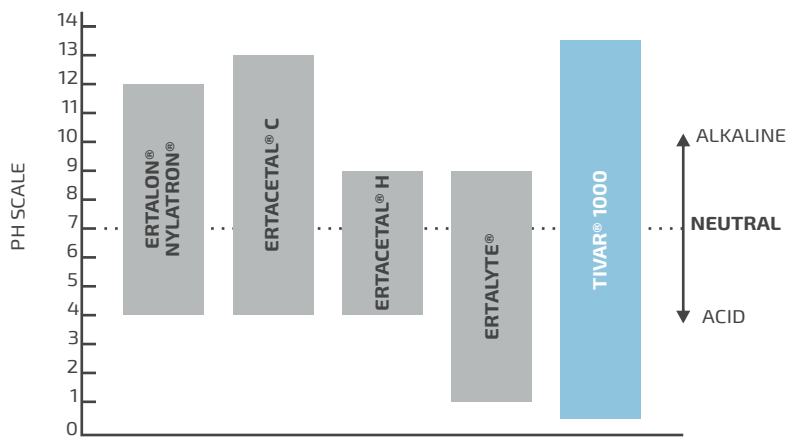

↑ ALKALINE  
 ● NEUTRAL  
 ↓ ACID

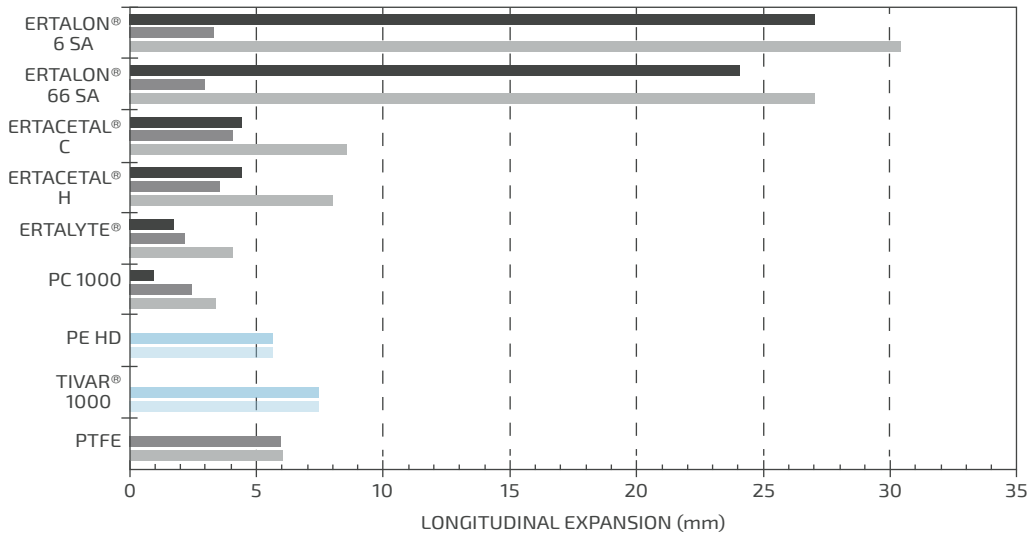

**TEST CONDITIONS**

Expansion of a long strip of 1,000mm (dry, 23°C) when immersed in water at 60°C

**CAPTION**

- Expansion caused by the absorption of water in complete saturation
- Expansion caused by the increase in temperature from 23°C to 60°C
- Total expansion

**TENSILE STRESS ON ELASTIC LIMIT STRESS/RUPTURE\* ATT 23°C (ISO 527)**

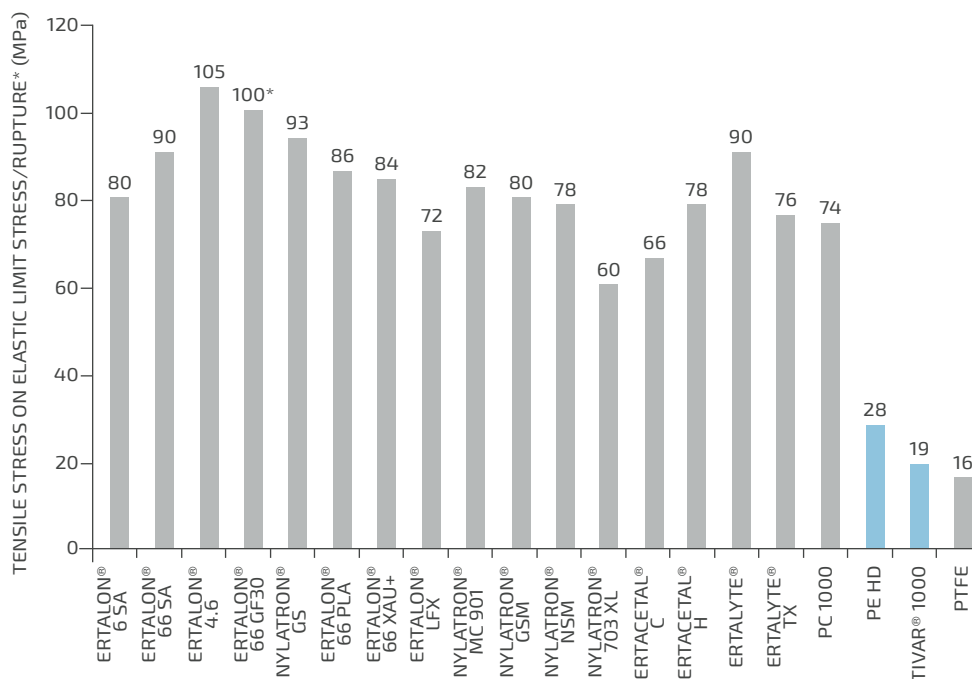

**TEST CONDITIONS**

- Measured on dry samples



# WEAR RESISTANCE AT 23°C

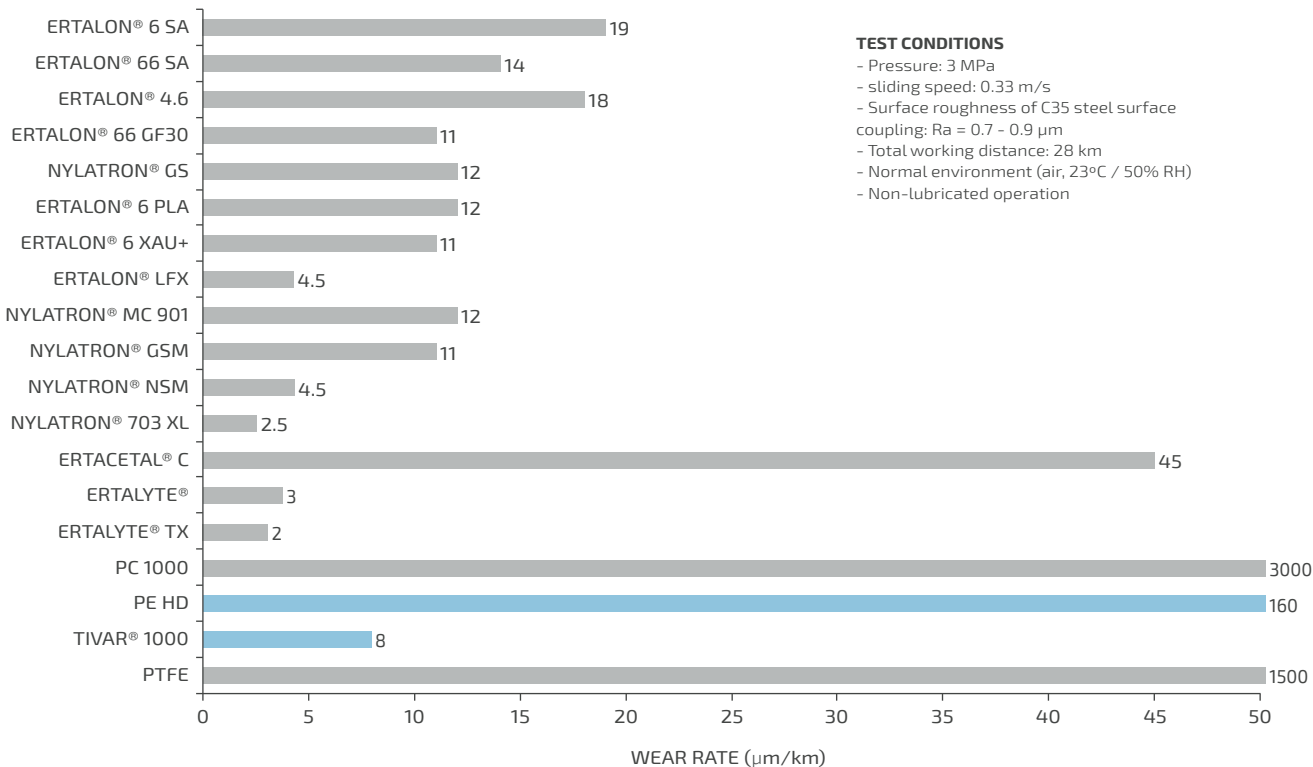

**TEST CONDITIONS**

- Pressure: 3 MPa
- sliding speed: 0.33 m/s
- Surface roughness of C35 steel surface coupling: Ra = 0.7 - 0.9 µm
- Total working distance: 28 km
- Normal environment (air, 23°C / 50% RH)
- Non-lubricated operation

# COMPRESSION STRESS AT 23°C (ISO 604)

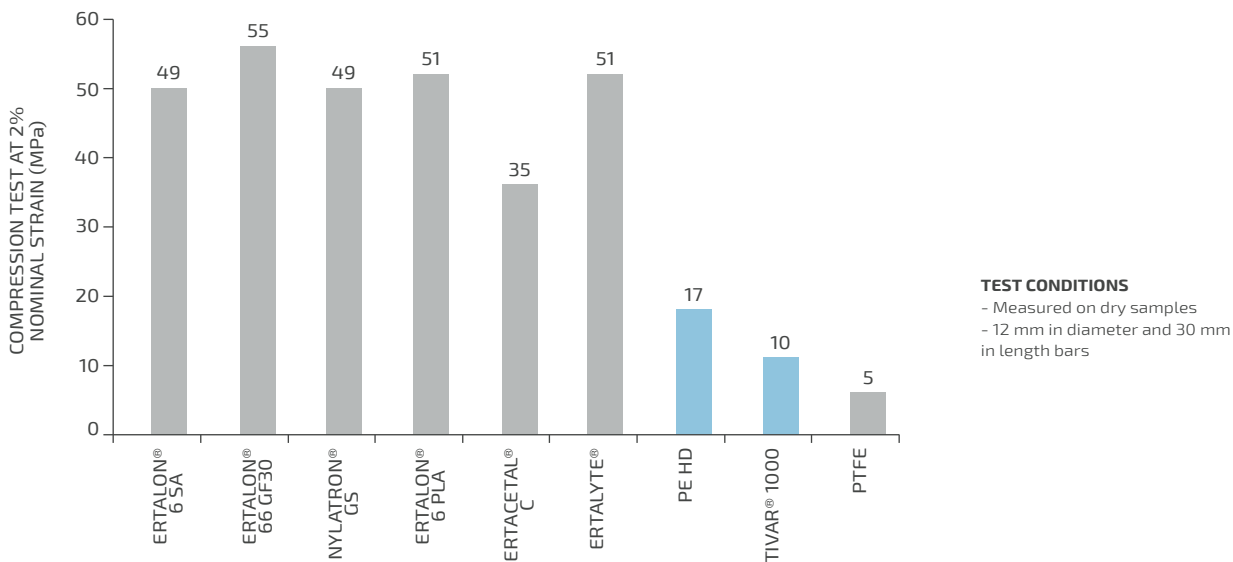

**TEST CONDITIONS**

- Measured on dry samples
- 12 mm in diameter and 30 mm in length bars

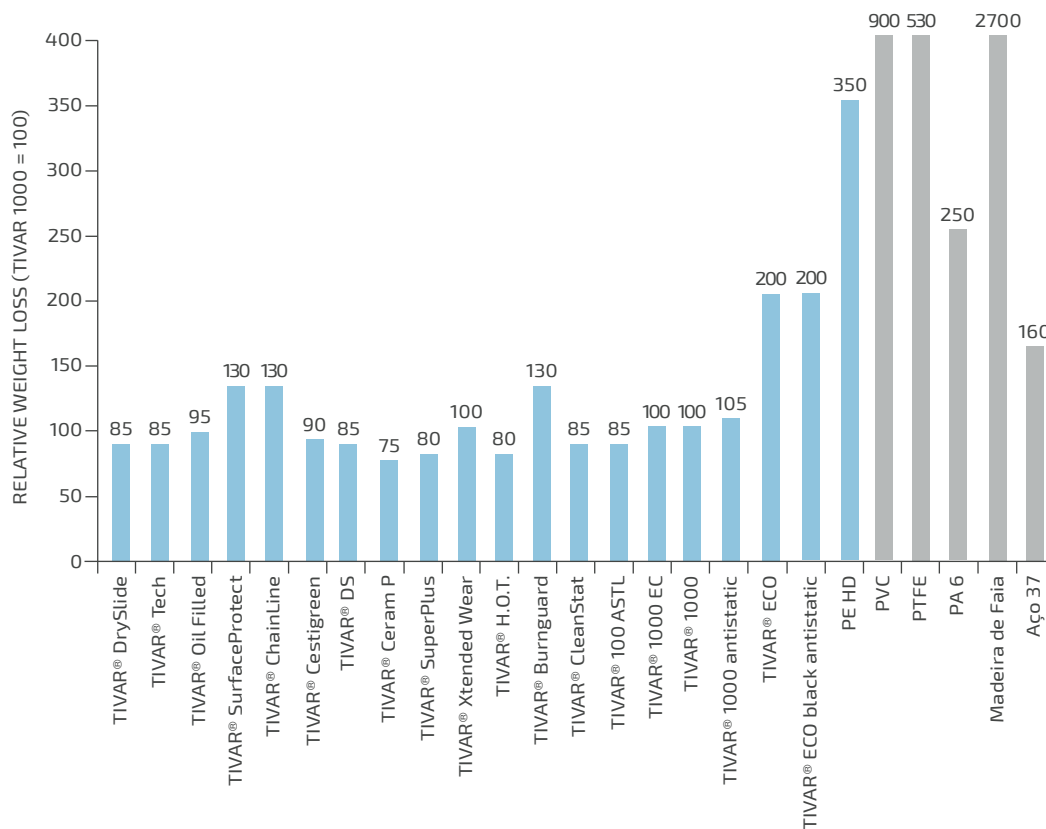

## DYNAMIC FRICTION COEFFICIENT AT 23°C

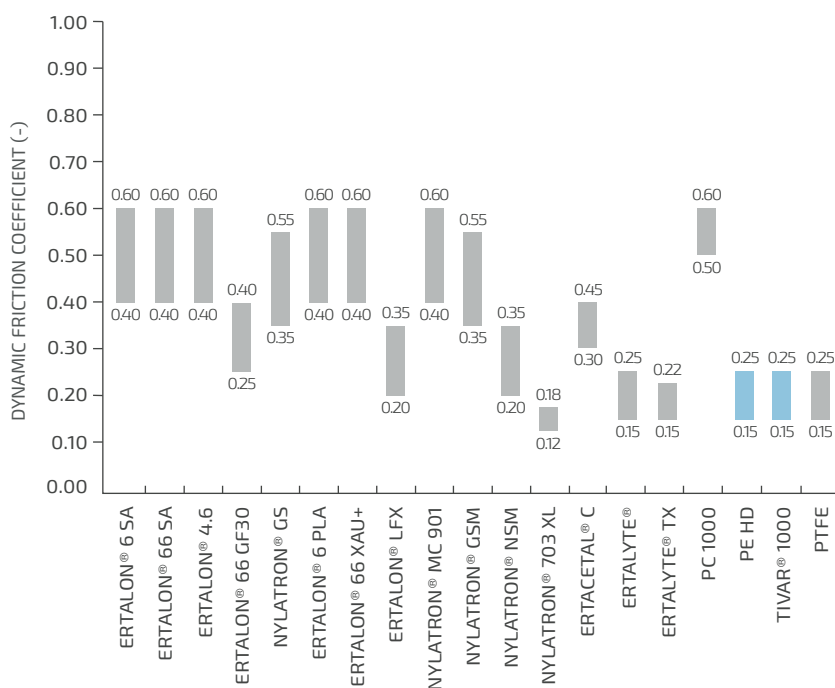

### TEST CONDITIONS

- Pressão: 3 MPa
- Velocidade de deslizamento: 0.33 m/s
- Rugosidade de superfície do aço C35 acoplamento da superfície: Ra = 0.7 - 0.9 µm
- Distância total de funcionamento: 28 km
- Ambiente normal (ar, 23°C/50% RH)
- Operação não lubrificada





# HYDROLYSIS RESISTANCE

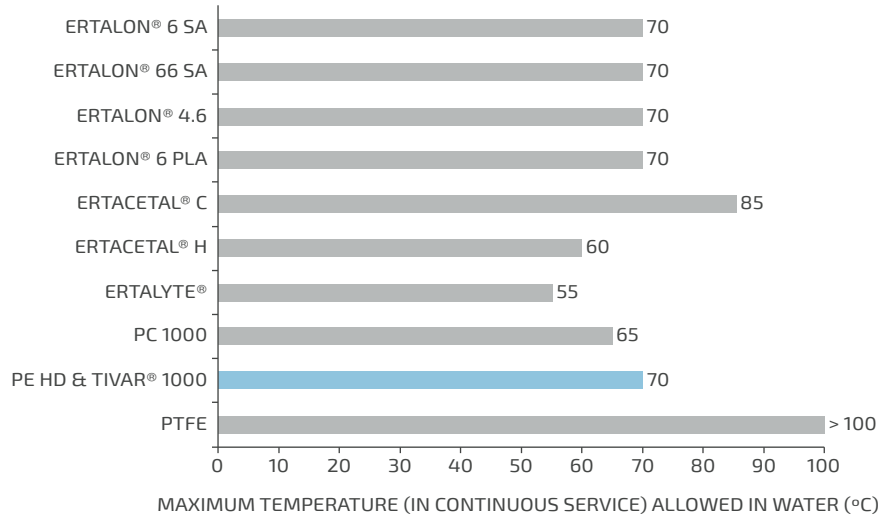

# SUNLIGHT RESISTANCE (UV RAYS)

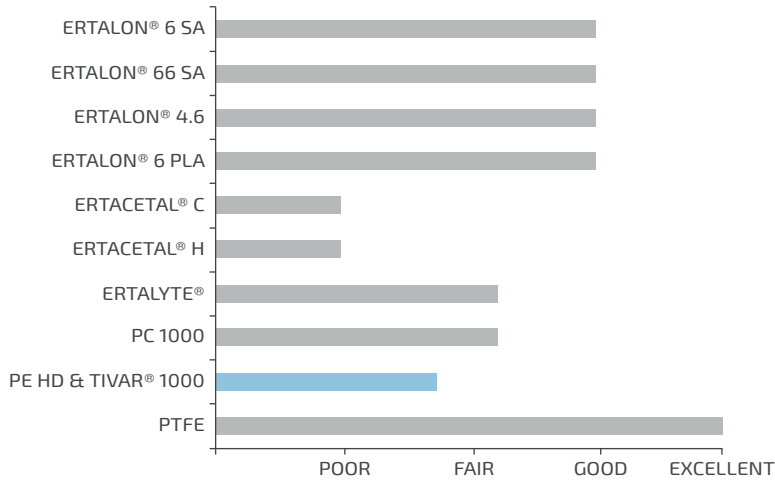

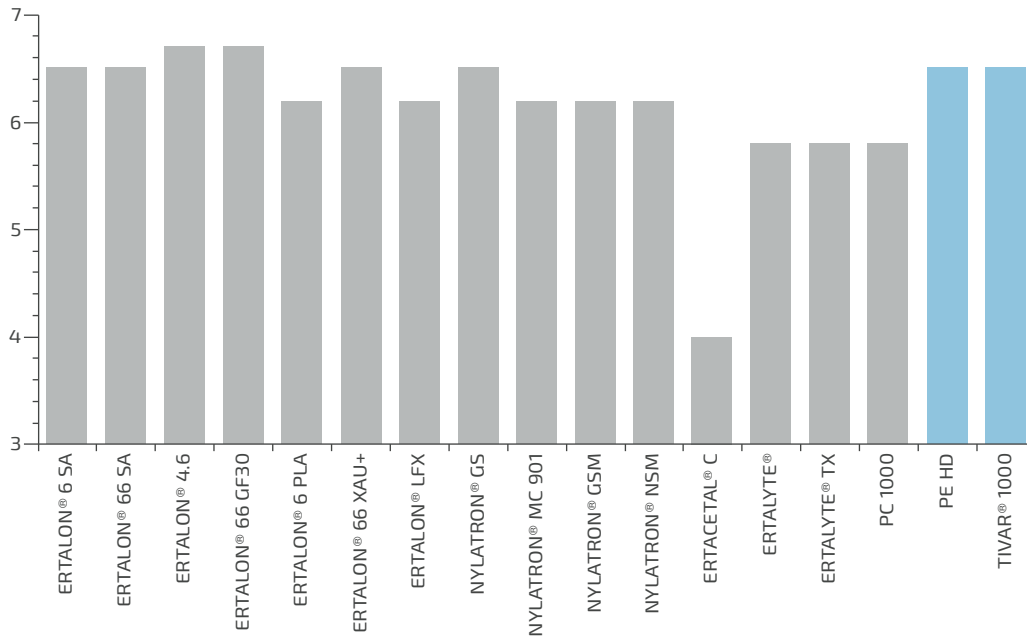

**1 Gray = 100 Rad**  
**10<sup>6</sup> Gray = 100 Mrad**  
**1 Mrad = 10 kJ/kg**

The radiation index (RI) is defined as the logarithm, base 10, of the dose absorbed in the GRAY in which the flexural stress at rupture or flexural tension at rupture of the tested material is reduced to 50% of its original value under irradiation conditions (the most sensitive to radiation)

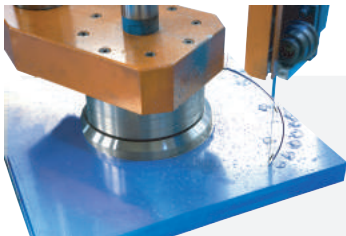

DIFFERENT TYPES OF HIGH PRECISION CUTTING **AT YOUR DISPOSAL!**

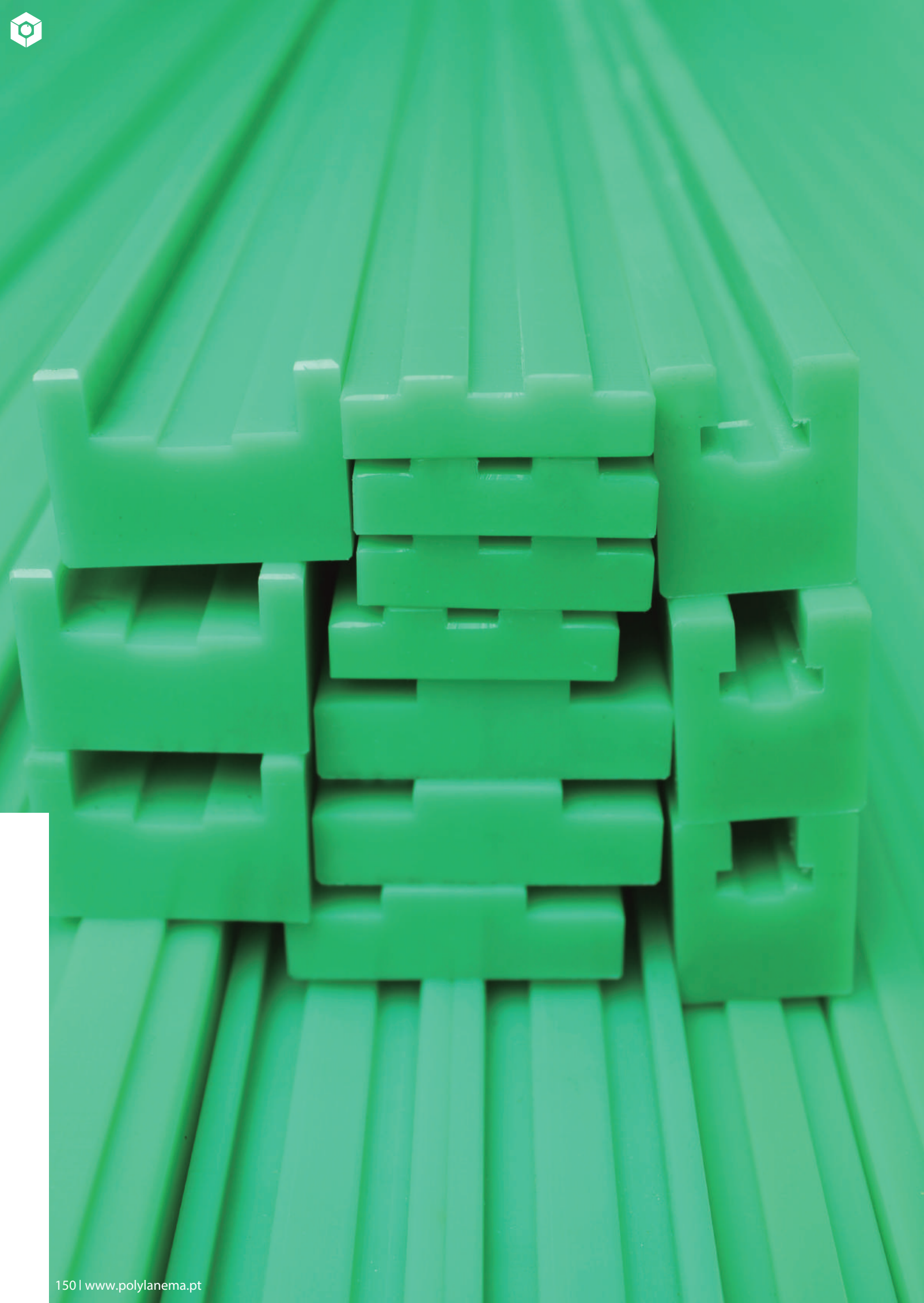

## ULTRA-HIGH-MOLECULAR-WEIGHT POLYETHYLENE PROFILES

Due to the high viscosity of the ultra-high-molecular-weight polyethylene (low MFI melt flow index), it is not possible to manufacturing them by conventional injection or extrusion machines. Thus, all LA brand profiles are manufactured from semi-finished products (pressed boards) obtained by sintering and melting the powder (polyethylene granulate) in computer presses at specific pressures and at high press times. The molecular weight of the various grades of polyethylene used in the manufacturing of the profiles may range from 5,000,000 to 9,000,000 g/mol from TIVAR® 1000 to TIVAR® TG1. The increase in molecular weight causes a few important characteristics in the polyethylene to be improved:

- Increases resistance to impact
- Increases resistance to wear due to friction or abrasion
- Decrease coefficient of friction

For these reasons, LANEMA profiles can be used in all applications where other low molecular weight profiles do not meet the requirements or where they fail prematurely. For applications where temperatures or high loads do not allow the use of ultra-high molecular weight polyethylene profiles, **we have the possibility to produce these profiles with glass fibre reinforced polyamides, molybdenum disulphide or oil and thermo-laminated.**

## PROFILES FOR DRIVE AND TRANSPORT

Due to their excellent characteristics, the ultra- high-molecular-weight polyethylene LANEMA profiles are increasingly used in transport and lifting technology (belts, chains or conveyors). Conventional slide profiles made of steel or other materials always produce great wear on the rollers and chain links especially if the lubrication is poor. The LANEMA profiles, in addition to supporting and guiding the chains, allow:

- Reduce the effects of inertia forces on the chains which decrease the drive mechanical power.
- Drastically reduce the contact noise of the chains with the guides.
- Increase service life of chains/belts
- Decrease maintenance since LANEMA profiles are self-lubricating even in dry environments.
- Food contact, as they are physiologically inert
- Working temperatures from -40° to 80°C and with no moisture absorption

## TESTING CONDITIONS

LANEMA profiles can be used at temperatures ranging between -40° and 80° C and can even reach 120° C in short periods. If the application is exposed to higher temperatures, you should choose another material (consult our technical department).

Polyethylene have no water absorption and therefore, in relation to dimensional stability, only dilation due to the temperature increase should be considered. On average, the profile increases by 2mm/meter per 10°C in the temperature range of 20° to 100°C.

To avoid profile bends, there should also be clearances between the various sections. They should preferably be cut at 45° to allow sliding.

Chemically, polyethylene is not affected by aqueous solutions of acids and alkalis or salts as in most solvents. Only the aromatic hydrocarbon is dissolved and hydrogenated at high temperatures.





# STANDARD PROFILES SELECTION

The selection of the material depends on the type of application of the loads involved, the speeds and temperatures, among others.  
Values below are for comparison:

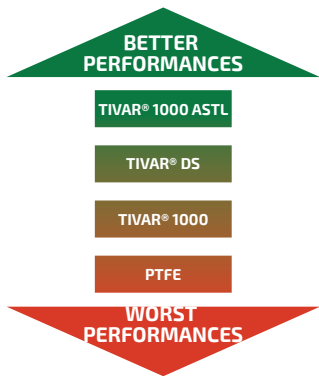
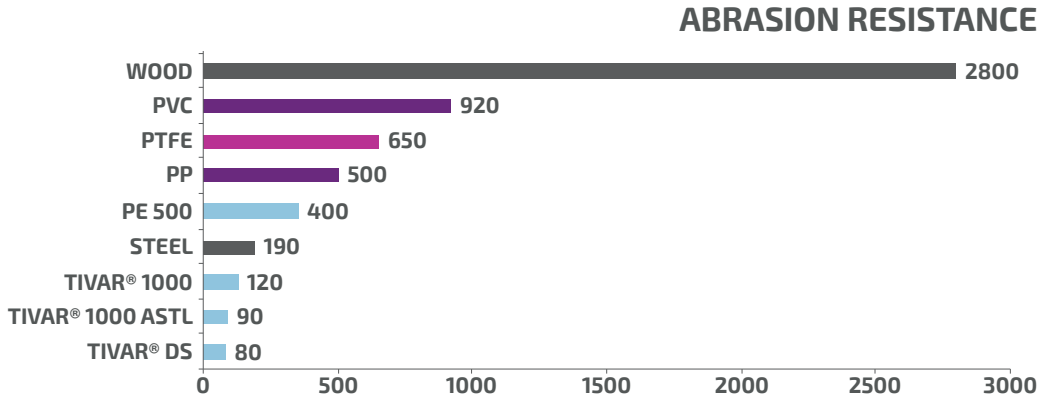

### COEFFICIENT OF FRICTION

Testing conditions: 10 N / mm<sup>2</sup> in water.

The coefficient of friction depends on the speed, surface pressure, material and contact surface on which friction occurs. The coefficient of friction increases with speed and decreases with increased pressure.

## PROPERTIES

Poly Lanema has the possibility to produce the requested profile with the material that the client wishes or that our technical department advises. In case the selected material is polyethylene, the table and the graphics on pages 142-149, present the most important characteristics. The data listed are within the normal range of the product properties but should not be used to establish the limits of the specified material nor be used as the sole study basis.

If the polyethylene does not meet the required load and/or temperature requirements, or even if the application conditions are more demanding than what is allowed, other materials are available for all types of applications.

# STANDARD PROFILES

## ROLLER CHAIN PROFILES



### SINGLE CHAIN

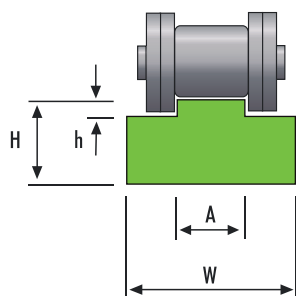

REFERENCE	STEP	ISO	A	h	W	H	Kg/m
LA - 0	3/8"	06 - B1	5.5	1.5	15	10	0.130
LA - 1	1/2"	08 - B1	7.5	2.2	20	10	0.165
LA - 2	1/2"	08 - B1	7.5	2.2	20	15	0.26
LA - 3	5/8"	10 - B1	9.3	2.6	20	10	0.16
LA - 4	5/8"	10 - B1	9.3	2.6	20	15	0.26
LA - 5	3/4"	12 - B1	11.3	2.4	25	10	0.21
LA - 6	3/4"	12 - B1	11.3	2.4	25	15	0.325
LA - 7	1"	16 - B1	16.5	3.5	40	15	0.47
LA - 8	1"	16 - B1	16.5	3.5	40	20	0.66
LA - 9	1" 1/4	20 - B1	19	4.2	45	15	0.53
LA - 10	1" 1/4	20 - B1	19	4.3	45	20	0.72
LA - 11	1" 1/2	24 - B1	24.7	5.5	60	15	0.665
LA - 12	1" 3/4	28 - B1	30.1	6.8	75	20	1.13
LA - 13	2"	32 - B1	30.1	7.7	80	20	1.15
LA - 14	2"	32 - B1	30.1	7.7	85	20	1.21

### DOUBLE CHAIN

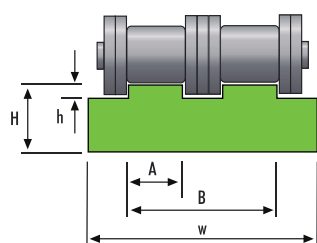

REFERENCE	STEP	ISO	W	H	A	h	B	Kg/m
LA - 15	3/8"	06 - B2	25	10	5.5	1.5	15.7	0.250
LA - 16	1/2"	08 - B2	35	10	7.5	2.2	21.4	0.360
LA - 17	5/8"	10 - B2	40	10	9.3	2.6	25.9	0.425
LA - 18	5/8"	10 - B2	40	15	9.3	2.6	25.9	0.524
LA - 19	3/4"	12 - B2	45	10	11.3	2.4	30.8	0.480
LA - 20	3/4"	12 - B2	45	15	11.3	2.4	30.8	0.598
LA - 21	1"	16 - B2	48.4	15	16.5	3.5	48.4	0.820
LA - 22	1"	16 - B2	48.4	20	16.5	3.5	48	1.156
LA - 23	1" 1/4	20 - B2	55.5	15	19	4.2	55.5	0.930
LA - 24	1" 1/4	20 - B2	55.5	20	19	4.2	55.5	1.232
LA - 25	1" 1/2	24 - B2	73.1	20	24.7	5.5	73.1	1.620
LA - 26	1" 3/4	28 - B2	89.7	25	30.1	6.8	89.7	2.490
LA - 27	2"	32 - B2	88.7	30	30.1	7.7	88.7	2.930

### TRIPLE CHAIN

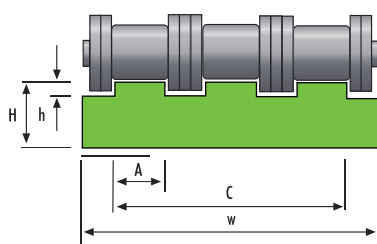

REFERENCE	STEP	ISO	W	H	A	h	C	Kg/m
LA - 28	3/8"	06 - B3	35	10	5.5	1.5	25.9	0.306
LA - 29	1/2"	08 - B3	45	10	7.5	2.2	35.3	0.381
LA - 30	1/2"	08 - B3	45	15	7.5	2.2	35.3	0.595
LA - 31	1/2"	08 - B3	45	20	7.5	2.2	35.3	0.808
LA - 32	5/8"	10 - B3	55	10	9.3	2.6	40.5	0.455
LA - 33	3/4"	12 - B3	65	10	11.3	2.4	50.3	0.546
LA - 34	1"	16 - B3	95	15	16.5	3.5	80.3	1.167
LA - 35	1" 1/4	20 - B3	105	15	19	4.2	92	1.304
LA - 36	1" 1/2	24 - B3	135	20	24.7	5.5	121.5	2.247
LA - 37	1" 3/4	28 - B3	170	25	30.1	6.8	149.3	3.522
LA - 38	2"	32 - B3	170	30	30.1	7.7	149.3	4.262

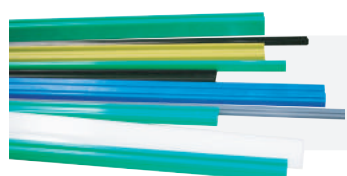

WE MANUFACTURE PROFILES  
TO YOUR MEASURE.





# STANDARD PROFILES

## ROLLER CHAIN PROFILES

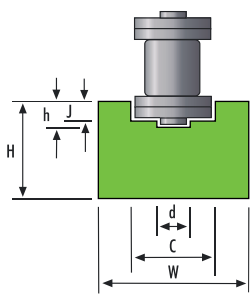

REFERENCE	STEP	ISO	W	H	C	h	J	d	Kg/m
LA - 39	3/8"	06 - B1	20	15	9.2	4.2	2.8	3.7	0.257
LA - 40	1/2"	08 - B1	25	15	12.7	4.8	3.5	4.9	0.308
LA - 41	5/8"	10 - B1	25	15	15.2	5.1	3.6	5.5	0.296
LA - 42	3/4"	12 - B1	25	20	16.7	5.7	3.9	6.2	0.403
LA - 43	1"	16 - B1	35	25	24.4	9.9	8.4	8.9	0.624

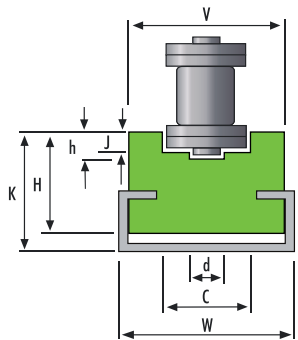

REFERENCE	STEP	ISO	W	V	H	C	K	h	J	d	RAIL	Kg/m
LA - 44	3/8"	06 - B1	20	10	10	9.2	15	4.2	2.8	4	C 2010	0.290
LA - 45	1/2"	08 - B1	24	20	9	12.7	11	4.8	3.5	4.9	C 2405	0.145
LA - 46	5/8"	10 - B1	28	23	12	15.2	18	5.1	3.6	5.5	C 2812	0.200
LA - 47	3/4"	12 - B1	28	23	12	16.7	18	5.7	3.9	6.2	C 2812	0.200
LA - 48	1"	16 - B1	38	32.5	20	24.4	30	9.9	8.4	8.9	C 3818	0.770
LA - 48 - A	1" 1/4	20 - B1	60	60	25	28.0	35	11.9	10.0	11	C 6020	1.040
LA - 48 - B	1" 1/2	24 - B1	60	60	30	35.0	40	14.9	13.0	16	C 6020	1.340
LA - 48 - C	1" 3/4	28 - B1	60	65	40	39.0	45	18.0	16.0	17	C 6020	1.840
LA - 48 - D	2"	32 - B1	60	70	40	44.0	45	21.7	16.0	19	C 6020	2.040

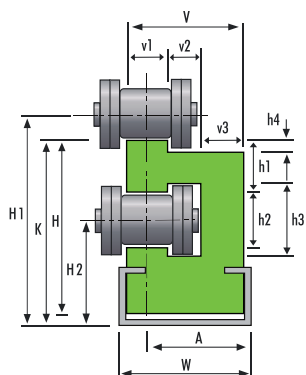

REFERENCE	STEP	ISO	W	V	H1	H2	A	K	H	h1	h2	h3	h4	v1	v2	v3	RAIL	Kg/m
LA - 49	3/8"	06 - B1	20	20	30.2	17	14.5	27	24	6.6	6.6	9.3	1.5	5.2	4.3	10.4	C 2010	0.470
LA - 50	1/2"	08 - B1	20	20	33.8	18	16.5	30	27	7.1	8.7	12.8	2.2	7.5	5.0	7.5	C 2010	0.530
LA - 51	5/8"	10 - B1	20	20	41.1	21	15.5	36	33	9.7	10.4	15.4	2.6	9.3	5.3	5.5	C 2010	0.690
LA - 52	3/4"	12 - B1	28	24.3	46.5	24	18.5	41	37	10.2	12.3	16.9	2.4	11.5	6.0	6.8	C 2812	0.750
LA - 53	1"	16 - B1	28	33.5	62.0	34	25	54	50	11.9	16.1	24.4	3.5	16.5	10.5	6.5	C 2812	2.150

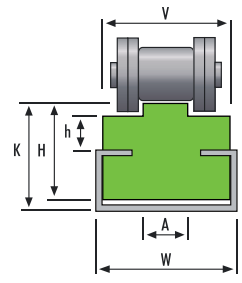

REFERENCE	STEP	ISO	W	V	H	K	h	A	RAIL	Kg/m
LA - 54	3/8"	06 - B1	20	15	15	17	1.5	5.4	C 2010	0.620
LA - 55	1/2"	08 - B1	24	20	9	11	2.2	7.5	C 2405	0.120
LA - 55 - A	1/2"	08 - B1	20	17	15	17	2.2	7.5	C 2010	0.130
LA - 56	5/8"	10 - B1	20	17	15	17	2.6	9.3	C 2010	0.135
LA - 57	3/4"	12 - B1	20	20	15	17	2.4	11.3	C 2812	0.175
LA - 57 - A	3/4"	12 - B1	28	23.5	15	18	2.4	11.3	C 2812	0.289
LA - 58	1"	16 - B1	28	23.5	15	18	3.5	16.5	C 2812	0.297
LA - 59	1" 1/4	20 - B1	28	28	15	18	4.3	19.0	C 2812	0.345
LA - 60	1" 1/2	24 - B1	38	33	25	30	5.5	24.7	C 3818	0.635
LA - 61	1" 3/4	28 - B1	38	38	25	30	6.8	30.1	C 3818	0.731
LA - 62 - A	2"	32 - B1	38	38	25	30	7.7	30.1	C 3818	0.710
LA - 62 - B	2"	32 - B1	60	60	25	35	7.7	30.1	C 6020	1.240

STANDARD PROFILES

# STANDARD PROFILES

## ROLLER CHAIN PROFILES

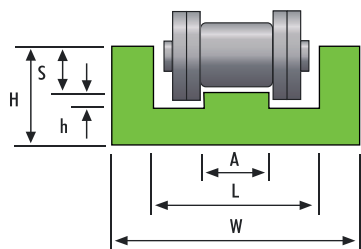

REFERENCE	STEP	ISO	W	H	L	h	A	S	Kg/m
LA - 62	3/8"	06 - B1	20	10	13	1.5	5.5	1.1	0.188
LA - 63	1/2"	08 - B1	25	15	16.3	2.2	7.5	1.6	0.352
LA - 64	5/8"	10 - B1	28	15	19.2	2.6	9.3	2.1	0.394
LA - 65	3/4"	12 - B1	30	20	21.8	2.4	11.3	2.8	0.564
LA - 66	1"	16 - B1	42	25	33.8	3.5	16.5	3.3	0.987
LA - 66 - A	1 1/4"	20 - B1	50	25	40	4.2	19	4	1.175

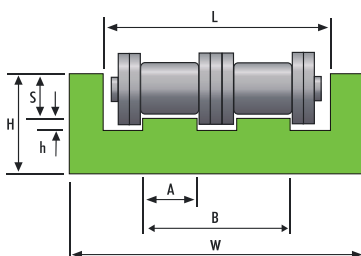

REFERENCE	STEP	ISO	W	H	L	h	A	S	B	Kg/m
LA - 67	3/8"	06 - B2	36	15	26	1.5	5.4	4.4	16	0.390
LA - 68	1/2"	08 - B2	45	20	35	2.2	7.4	7.2	21	0.620
LA - 69	5/8"	10 - B2	50	25	40	2.6	9.2	9.5	26	0.816
LA - 70	3/4"	12 - B2	56	25	46	2.4	11.3	11.1	31	0.810
LA - 71	1"	16 - B2	85	30	75	3.5	16.5	16.5	48	1.200

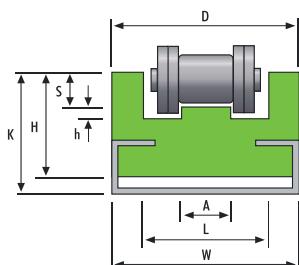

REFERENCE	STEP	ISO	W	D	H	K	L	h	A	S	CALHA	Kg/m
LA - 72	3/8"	06 - B1	20	20	14	17	13	1.5	5.5	1.1	C 2010	0.772
LA - 73	1/2"	08 - B1	20	25	16	20	16.3	2.2	7.5	1.6	C 2812	0.890
LA - 74	5/8"	10 - B1	28	28	16	20	19.2	2.6	9.3	2.1	C 2812	1.307
LA - 75	3/4"	12 - B1	28	30	18	22	21.8	2.4	11.3	2.8	C 2812	1.367
LA - 76	1"	16 - B1	38	42	25	30	33.8	3.5	16.5	3.3	C 3818	2.417
LA - 76 - A	1 1/4"	20 - B1	38	50	30	35	40.0	4.2	19	4.0	C 3818	2.840

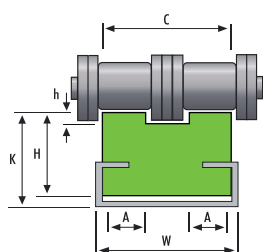

REFERENCE	STEP	ISO	W	H	K	h	A	C	CALHA	Kg/m
LA - 77	3/8"	06 - B2	20	10	15	1.5	5.4	20	C 2010	0.615
LA - 78	1/2"	08 - B2	20	15	17	2.2	7.5	21.4	C 2010	0.240
LA - 79	5/8"	10 - B2	20	15	17	2.6	9.3	25.7	C 2812	0.260
LA - 80	3/4"	12 - B2	28	15	20	2.4	11.3	30.7	C 2812	0.330
LA - 80 - A	1"	16 - B2	38	15	27	3.5	16.5	48.0	C 3818	0.650
LA - 80 - B	1 1/4"	20 - B2	38	15	30	4.3	19.0	55.0	C 3818	0.925
LA - 80 - C	1 1/2"	24 - B2	38	15	35	5.5	24.7	72.0	C 3818	1.425

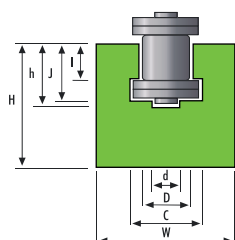

REFERENCE	STEP	ISO	W	H	C	h	l	d	J	D	Kg/m
LA - 81	3/8"	06 - B1	20	25	9.3	9.9	5.6	4	8.7	6.6	0.414
LA - 82	1/2"	08 - B1	24	30	12.8	12.7	7.6	5	11.5	8.7	0.564
LA - 83	5/8"	10 - B1	30	35	15.4	14.8	9.3	6	13.5	10.4	0.832
LA - 84	3/4"	12 - B1	40	35	16.9	17.5	11.5	7.9	15.9	12.3	1.106
LA - 85	1"	16 - B1	40	45	24.4	27.0	16.5	9	25.7	16.1	1.231
LA - 86	1 1/4"	20 - B1	50	50	27.5	32.0	19.0	11	30.0	19.3	1.726
LA - 87	1 1/2"	24 - B1	60	60	36.5	40.1	25.2	16	38.2	25.7	2.332
LA - 88	1 3/4"	28 - B1	60	70	41.5	48.9	30.8	17	46.9	28.3	2.473
LA - 89	2"	32 - B1	70	75	44.5	53.0	30.8	19	47.3	29.6	3.264



# ROLLER CHAIN PROFILES

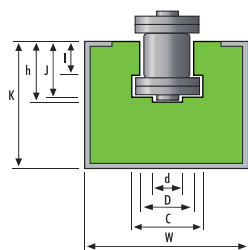

REFERENCE	STEP	ISO	W	K	I	J	h	d	D	C	RAIL	Kg/m
LA - 90	3/8"	06 - B1	30	24	5.6	8.7	9.9	4	6.6	9.3	C 3024	0.340
LA - 91	1/2"	08 - B1	30	24	7.6	11.5	12.7	5	8.7	12.8	C 3024	0.340
LA - 92	1/2"	08 - B1	28	16	6.3	10.2	11.3	5	8.7	12.8	C 2816	0.340
LA - 93	5/8"	10 - B1	30	24	9.3	13.5	14.8	6	10.4	15.4	C 3024	0.340
LA - 94	3/4"	12 - B1	30	24	11.3	15.9	17.5	7.9	12.3	16.9	C 3024	0.340
LA - 95	1"	16 - B1	45	40	16.5	25.7	27.0	9	16.1	24.4	C 4540	1.150
LA - 95 - A	1" 1/4	20 - B1	45	40	19.0	30	32	11	19.3	27.5	C 4540	1.050

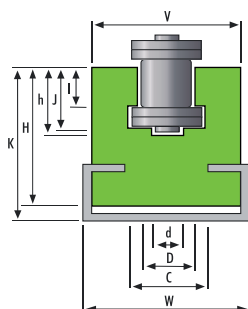

REFERENCE	STEP	ISO	W	H	V	K	I	J	h	d	D	C	RAIL	Kg/m
LA - 96	3/8"	06 - B1	20	17.5	20	21	5.6	8.7	9.9	4	6.6	9.3	C 2010	0.192
LA - 97	1/2"	08 - B1	28	27.5	24	32	7.6	11.5	12.7	5	8.7	12.8	C 2812	0.502
LA - 98	1/2"	10 - B1	28	27.5	24	32	9.3	13.5	14.8	6	10.4	15.4	C 2812	0.452
LA - 99	5/8"	12 - B1	38	34.0	38	43	11.5	15.9	17.5	7.9	12.3	16.9	C 3818	0.729
LA - 100	1"	16 - B1	38	40	38	50	16.5	25.7	27.0	9	16.1	24.4	C 3818	0.620
LA - 101	1" 1/4	20 - B1	60	45	60	55	19.0	30.0	32.0	11	19.3	27.5	C 6020	2.640
LA - 102	1" 1/2	24 - B1	60	55	60	65	25.2	38.2	40.1	16	25.7	36.5	C 6020	2.840
LA - 103	1" 3/4	28 - B1	60	70	70	80	30.8	46.9	48.9	17	28.3	41.5	C 6020	4.040
LA - 104	2"	32 - B1	60	70	70	80	30.8	47.3	53.0	19	29.6	44.5	C 6020	4.040

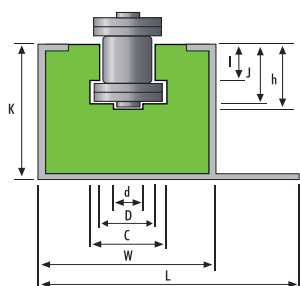

REFERENCE	STEP	ISO	K	W	L	I	J	h	d	D	C	RAIL	Kg/m
LA - 105	3/8"	06 - B1	25	31	53	5.6	8.7	9.9	4	6.6	9.3	C 5325	1.14
LA - 106	1/2"	08 - B1	25	31	53	7.6	11.5	12.7	5	12.8	12.8	C 5325	1.10
LA - 107	5/8"	10 - B1	25	31	53	9.3	13.5	14.8	6	15.4	15.4	C 5325	1.05
LA - 108	3/4"	12 - B1	25	31	53	11.5	15.9	17.5	7.9	12.3	16.9	C 5325	1.05

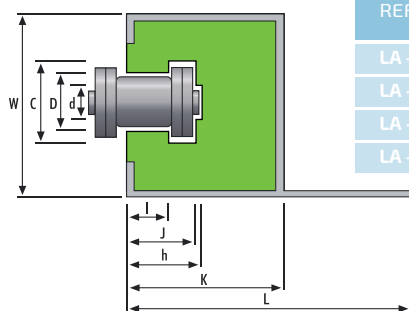

REFERENCE	STEP	ISO	K	W	L	I	J	h	d	D	C	RAIL	Kg/m
LA - 109	3/8"	06 - B1	31	25	47	5.6	8.7	9.9	4	6.6	9.3	C 4725	0.95
LA - 110	1/2"	08 - B1	31	25	47	7.6	11.5	12.7	5	8.7	12.8	C 4725	0.95
LA - 111	5/8"	10 - B1	31	25	47	9.3	13.5	14.8	6	10.4	15.4	C 4725	0.90
LA - 112	3/4"	12 - B1	31	25	47	11.3	15.9	17.5	7.9	12.3	16.9	C 4725	0.84

STANDARD PROFILES

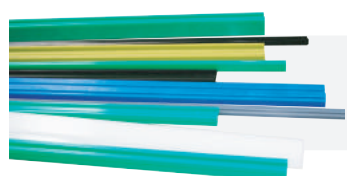

WE MANUFACTURE PROFILES  
TO YOUR MEASURE.

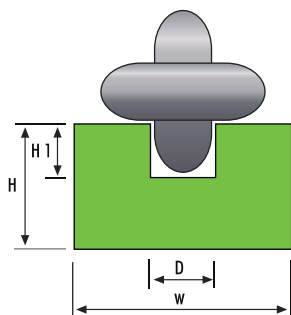

REFERENCE	W	H	D	H1	Kg/m
LA - 113	30	15	7	8	0.400
LA - 114	35	20	9	10	0.610
LA - 115	45	25	11	12	1.000
LA - 116	55	30	15	16	1.420

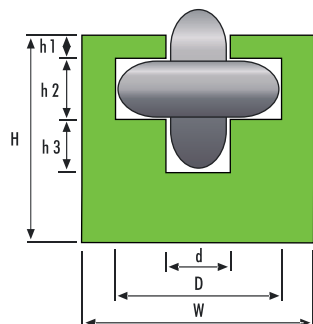

REFERENCE	W	H	D	d	h1	h2	h3	Kg/m
LA - 117	45	40	23	7	4.5	7	8	1.400
LA - 118	50	45	29	9	5.0	9	10	1.740
LA - 119	50	55	35	11	8.5	11	12	1.450
LA - 120	60	70	47	15	10.5	15	16	2.145

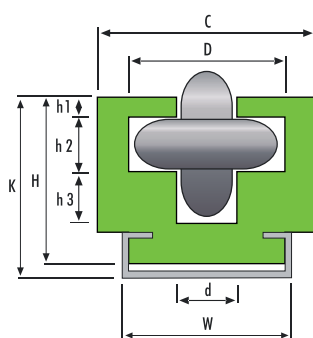

REFERENCE	W	C	H	K	D	d	h1	h2	h3	CALHA	Kg/m
LA - 121	45	38	40	45	23	7	4.5	7	8	C 3818	2.220
LA - 122	50	38	45	50	29	9	5.0	9	10	C 3818	2.820
LA - 123	50	38	55	60	35	11	8.5	11	12	C 3818	2.920
LA - 124	60	38	70	75	47	15	10.5	15	16	C 3818	4.120

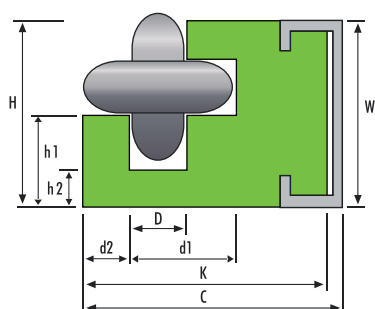

REFERENCE	W	H	K	C	D	d1	d2	h1	h2	CALHA	Kg/m
LA - 125	28	27.0	39	42	7	15	6	14	7	C 2812	0.250
LA - 126	28	32.0	37	42	9	19	6	16	9	C 2812	1.250
LA - 127	38	42.5	47	56	11	23	8	20	11	C 3818	2.220
LA - 128	38	54.0	60	69	13	31	10	26	13	C 3818	3.120

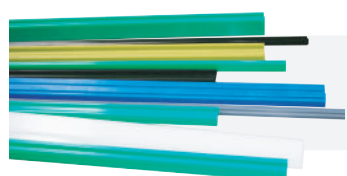

WE MANUFACTURE PROFILES  
**TO YOUR MEASURE.**



# STANDARD PROFILES

## CHAIN PROFILES

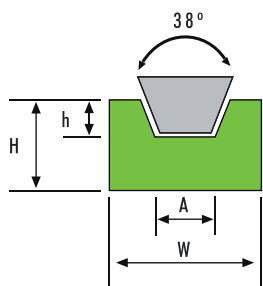

REFERENCE	W	H	h	A	Kg/m	CORREIA
LA - 129	20	10	3.5	6.0	0.170	8
LA - 130	20	10	4.5	7.2	0.170	10
LA - 131	20	12	6.0	9.2	0.170	13
LA - 132	30	15	8.0	11.5	0.334	17
LA - 133	30	20	9.0	13.5	0.435	20
LA - 134	35	20	10.5	14.5	0.500	22

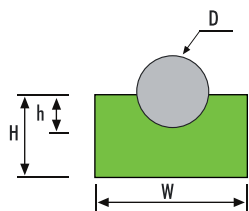

REFERENCE	D	W	H	h	Kg/m
LA - 136	3	20	10	3	0.185
LA - 137	4	20	10	4	0.185
LA - 138	5	20	12	5	0.200
LA - 139	6	25	15	6	0.301
LA - 140	7	30	20	8	0.485
LA - 141	9	35	25	10	0.700
LA - 142	10	40	25	12	0.785

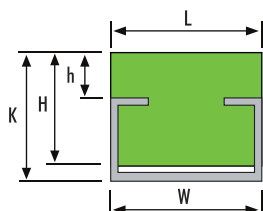

REFERENCE	W	L	K	H	h	CALHA	Kg/m
LA - 143	24	20	6	4	0.8	C 2405	0.070
LA - 144	24	20	11	9	5.8	C 2405	0.170
LA - 145	20	20	11	6	1	C 2010	0.090
LA - 146	20	20	16	10	6	C 2010	0.180
LA - 147	20	20	14	10	4	C 2010	0.180
LA - 148	20	20	17	15	7	C 2010	0.270
LA - 149	20	20	20	18	10	C 2010	0.366
LA - 150	28	28	15	10	3	C 2812	0.266
LA - 151	28	28	18	15	6	C 2812	0.399
LA - 152	38	38	22	15	4	C 3818	0.313
LA - 153	38	38	25	20	7	C 3818	0.632
LA - 154	60	60	30	20	10	C 6020	0.480

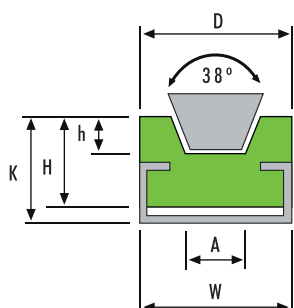

REFERENCE	W	D	H	h	K	A	CALHA	Kg/m	CORREIA
LA - 155	20	20	10	3.5	15	6.0	C 2010	0.140	8
LA - 156	20	20	15	4.5	18	7.2	C 2010	0.140	10
LA - 157	28	25	18	6.0	22	9.2	C 2812	0.341	13
LA - 158	28	30	18	9.0	24	11.5	C 2812	0.341	17
LA - 159	28	30	18	9.0	24	13.5	C 2812	0.341	20
LA - 160	38	35	25	10.5	30	14.5	C 3818	0.570	22

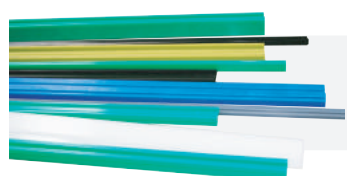

WE MANUFACTURE PROFILES  
TO YOUR MEASURE.

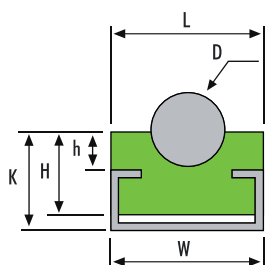

REFERENCE	D	W	L	H	h	K	RAIL	Kg/m
LA - 162	6	20	20	10	3	15	C 2010	0.145
LA - 163	8	20	20	15	4	18	C 2010	0.145
LA - 164	10	20	20	15	5	18	C 2010	0.145
LA - 165	12	28	25	15	6	20	C 2812	0.260
LA - 166	14	28	28	15	8	20	C 2812	0.250
LA - 167	18	38	33	20	10	25	C 3818	0.430
LA - 168	20	38	38	20	12	25	C 3818	0.420

## FLAT CHAIN PROFILES

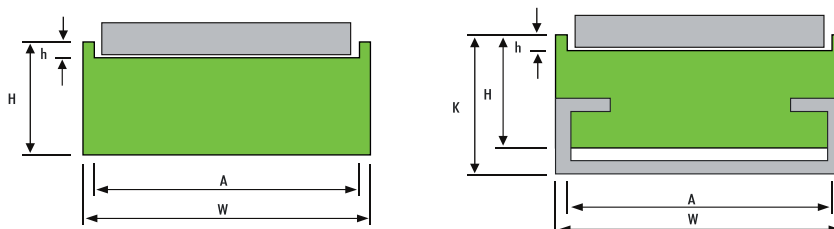

INDICATE DIMENSIONS UPON THE ORDER WITH OR WITHOUT RAIL



COLOR	H	W							
		15	20	25	30	35	40	45	50
GREEN	3	LA - 172	LA - 173	LA - 174	LA - 175	LA - 176	LA - 177	LA - 178	LA - 179
GREEN	5	LA - 180	LA - 181	LA - 182	LA - 183	LA - 184	LA - 185	LA - 186	LA - 187
BLACK	3	LA - 188	LA - 189	LA - 190	LA - 191	LA - 192	LA - 193	LA - 194	LA - 195
BLACK	5	LA - 196	LA - 197	LA - 198	LA - 199	LA - 200	LA - 201	LA - 202	LA - 203

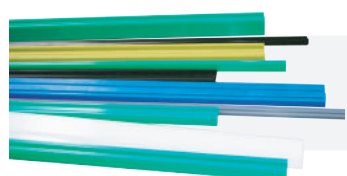

WE MANUFACTURE PROFILES  
TO YOUR MEASURE.





# SLIDING GUIDES

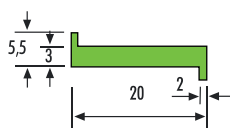

REF <sup>a</sup>	TYPE	COLOR
LA - 204	Z	GREEN
LA - 205	Z	BLACK

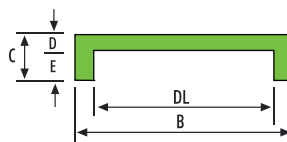

REF <sup>a</sup>	TYPE	COLOR
LA - 229	DL 31/21/41	GREEN
LA - 229	DL 31/21/41	BLACK

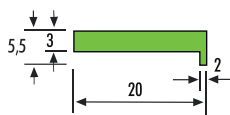

REF <sup>a</sup>	TYPE	COLOR
LA - 206	L	GREEN
LA - 207	L	BLACK

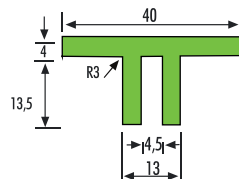

REF <sup>a</sup>	TYPE	COLOR
LA - 230	TCAL	GREEN

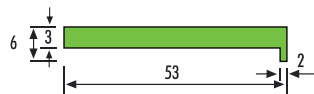

REF <sup>a</sup>	TYPE	COLOR
LA - 208	L/53	GREEN
LA - 209	L/53	BLACK

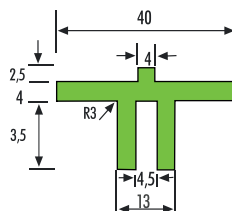

REF <sup>a</sup>	TYPE	COLOR
LA - 231	TCA	GREEN

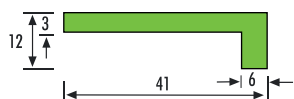

REF <sup>a</sup>	TYPE	COLOR
LA - 210	L/41	GREEN

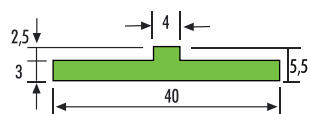

REF <sup>a</sup>	TYPE	COLOR
LA - 211	T	GREEN
LA - 212	T	BLACK

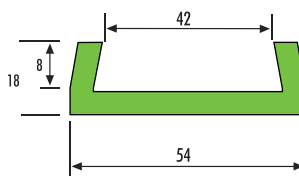

REF <sup>a</sup>	TYPE	COLOR
LA - 232	U/610	BLACK

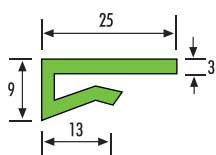

REF <sup>a</sup>	TYPE	COLOR
LA - 222	P - 25 mm	GREEN
LA - 223	P - 25 MM	BLACK

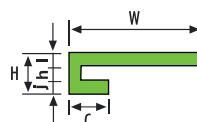

REF <sup>a</sup>	COLOR
LA - 233	GREEN

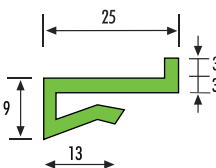

REF <sup>a</sup>	TYPE	COLOR
LA - 224	P/P	GREEN
LA - 224	P/P	BLACK

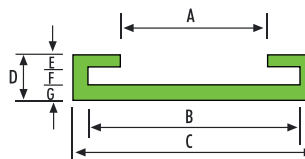

REF <sup>a</sup>	TYPE	COLOR
LA - 234	DC	GREEN
LA - 234	DC	BLACK

A - 40/32/23 E - 4.5/3/4  
 B - 51/42/38 F - 6.5/8.8/6.5  
 C - 60/50.5/46 G - 3.5/3.2/4  
 D - 14.5/15/14.5

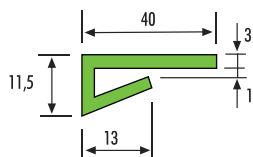

REF <sup>a</sup>	TYPE	COLOR
LA - 226	P - 40 mm	GREEN
LA - 227	P - 40 mm	BLACK

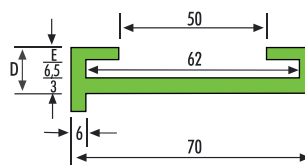

REF <sup>a</sup>	COLOR
LA - 235	GREEN
LA - 235	BLACK

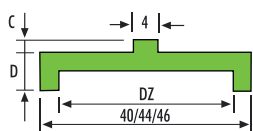

REF <sup>a</sup>	TYPE	COLOR
LA - 228	DZ 36/32/41	GREEN
LA - 228	DZ 36/32/41	BLACK

A - 40.5/38/41 D - 10/14/15  
 B - 45/46/46 E - 6/6/7.5  
 C - 5/6/5

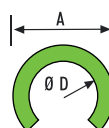

REF <sup>a</sup>	TYPE	COLOR
LA - 236	CLIP	GREEN
LA - 236	CLIP	BLACK
LA - 236	CLIP	WHITE

Dimensions on request.

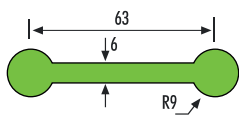

REF <sup>a</sup>	COLOR
LA - 237	GREEN
LA - 237	BLACK

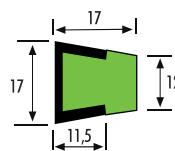

REF <sup>a</sup>	COLOR
LA - 246	WHITE
LA - 246	BLACK

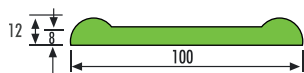

REF <sup>a</sup>	COLOR
LA - 238	GREEN

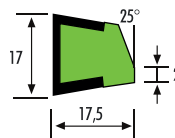

REF <sup>a</sup>	COLOR
LA - 247	WHITE
LA - 247	BLACK

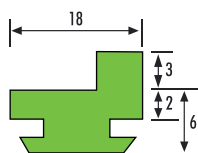

REF <sup>a</sup>	COLOR
LA - 239	GREEN
LA - 239	BLACK
LA - 239	WHITE

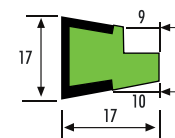

REF <sup>a</sup>	COLOR
LA - 248	WHITE
LA - 248	BLACK

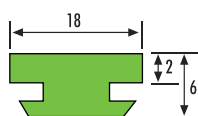

REF <sup>a</sup>	COLOR
LA - 240	GREEN
LA - 240	BLACK
LA - 240	WHITE

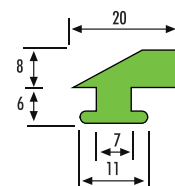

REF <sup>a</sup>	COLOR
LA - 249	WHITE
LA - 249	BLACK

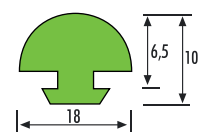

REF <sup>a</sup>	COLOR
LA - 241	GREEN
LA - 241	BLACK
LA - 241	WHITE

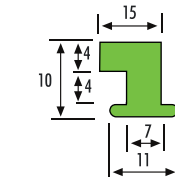

REF <sup>a</sup>	COLOR
LA - 250	GREEN
LA - 250	BLACK

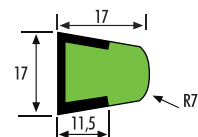

REF <sup>a</sup>	COLOR
LA - 242	WHITE
LA - 242	BLACK

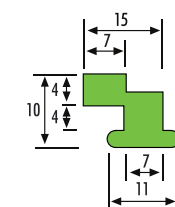

REF <sup>a</sup>	COLOR
LA - 251	GREEN
LA - 251	BLACK

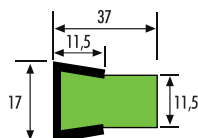

REF <sup>a</sup>	COLOR
LA - 243	WHITE
LA - 243	BLACK

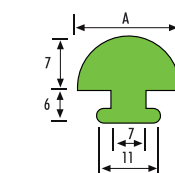

REF <sup>a</sup>	COLOR
LA - 252	GREEN
LA - 252	BLACK

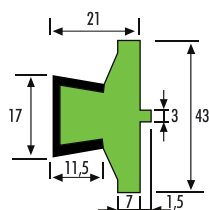

REF <sup>a</sup>	COLOR
LA - 244	WHITE
LA - 244	BLACK

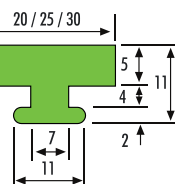

REF <sup>a</sup>	COLOR
LA - 253	GREEN
LA - 253	BLACK

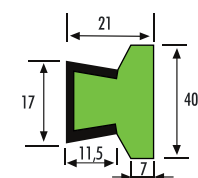

REF <sup>a</sup>	COLOR
LA - 245	WHITE
LA - 245	BLACK

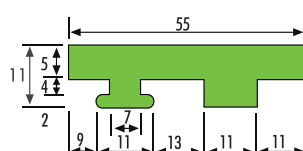

REF <sup>a</sup>	COLOR
LA - 254	GREEN
LA - 254	BLACK



# STARS AND SPINDLES FOR THE FILLING AND PACKAGING INDUSTRIES



SPINDLES  
AND STARS

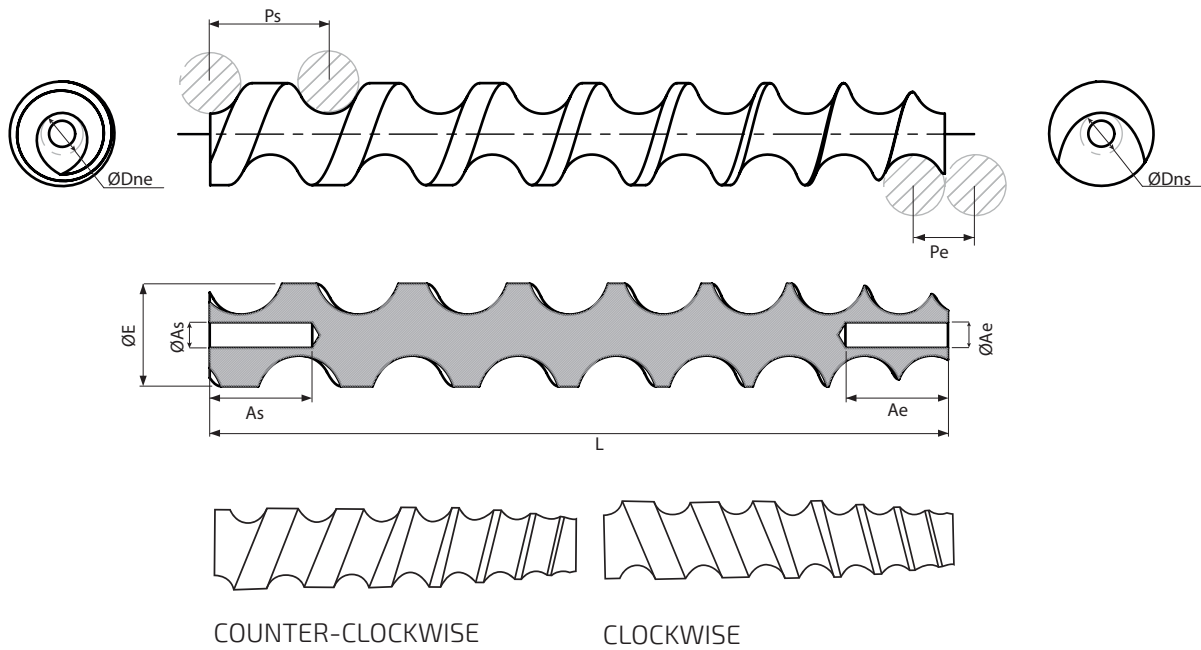

## STARS

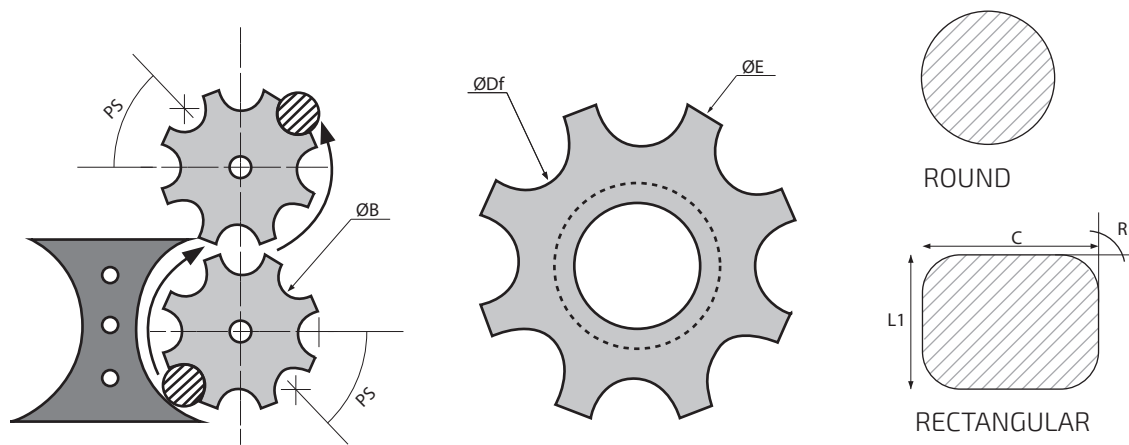

## TAKE INTO ACCOUNT:

- E = number of worm entries
- $N_p$  = number of turns
- Thread direction
- Inlet pitch = bottle diameter
- Exit pitch = star pitch
- $\varnothing B$  = bottle diameter

$\varnothing A_e$ = Inlet side bore	
$\varnothing A_s$ = Outlet side bore	
$A_e$ = inlet bore length	
$A_s$ = outlet bore length	
$\varnothing B$ = Bottle diameter	
$\varnothing D_e$ = Mounting bore diameter *	
$\varnothing D_t$ = Outer diameter	
$\varnothing D_{ne}$ = Inlet core diameter	
$\varnothing D_{ns}$ = Outlet core diameter	
$\varnothing D_f$ = Bottom diameter	
E = Maximum diameter	
L = Length	
$P_e$ = Inlet pitch	
$P_s$ = Outlet pitch	
R = Corner radius	
C = Package length	
$L_1$ = Package width	

\* Only when the entry hole passes through the entire worm

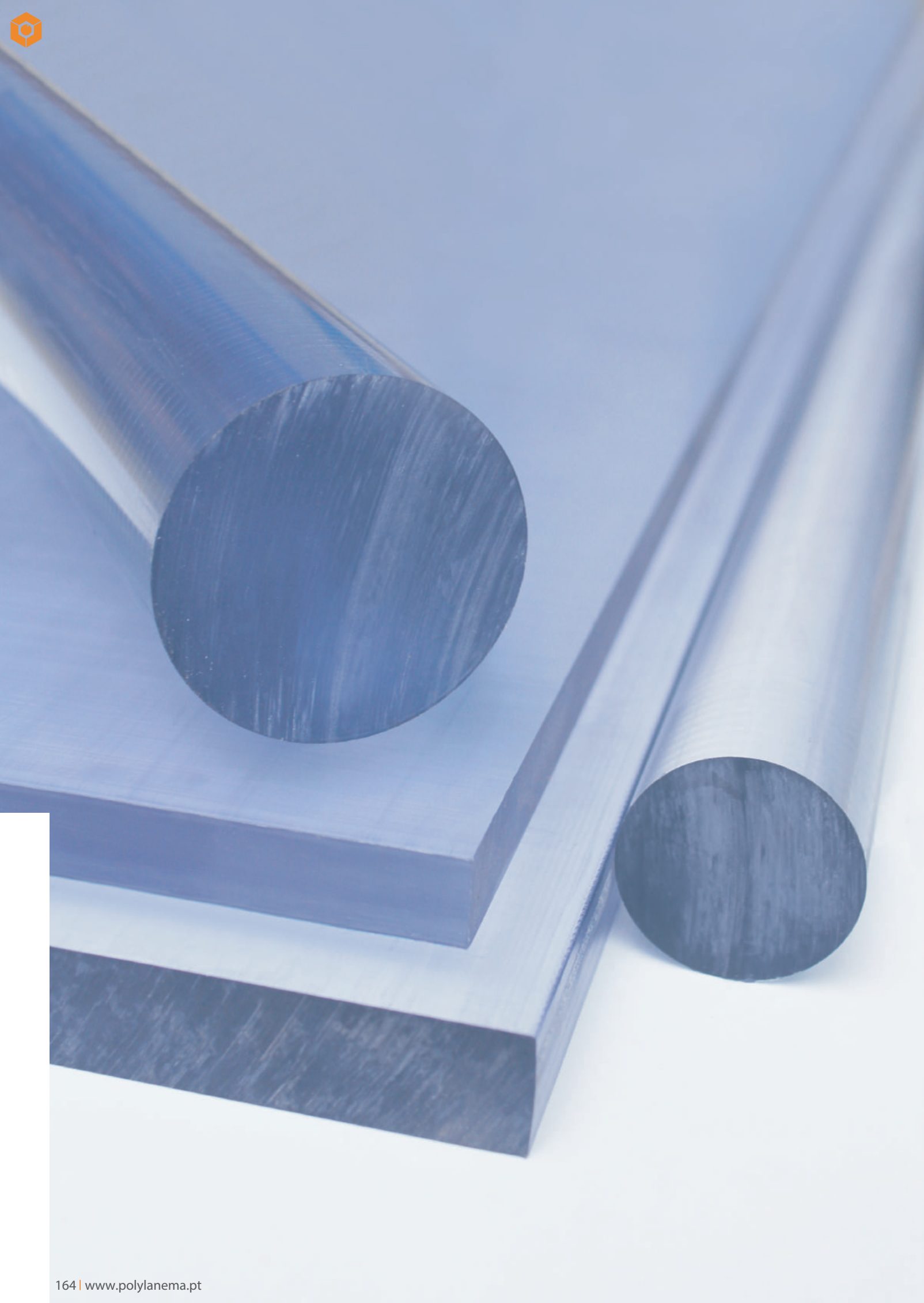



# PC 1000

PC

PC 1000		166
Technical Data		168





PC ●

# PC 1000

**Amorphous plastic**, PC 1000 has a high mechanical resistance as well as a good creep resistance. When faced with low temperatures, its level of resistance remains. Its dimensional stability is one of the important points, as well as its physiological inertia. PC 1000 is a translucent material and is used in many optical applications.

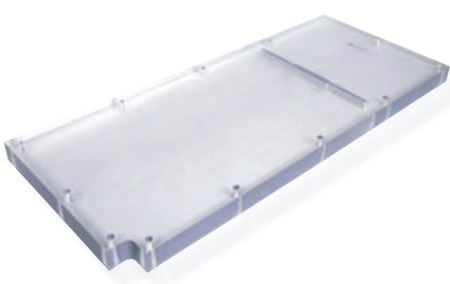

## MAIN CHARACTERISTICS

- Translucent
- High mechanical resistance
- Good creep resistance
- Excellent resistance to impact even at low temperatures
- It keeps rigidity over a wide range of temperatures
- Very good dimensional stability
- Physiologically inert

## APPLICATIONS

- Parts for precision machinery
- Parts for electrical insulation
- Parts in contact with food products
- Equipment/device for medical and pharmaceutical use
- Level or security porthole

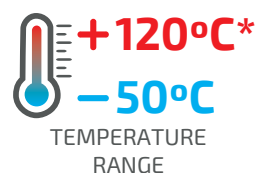
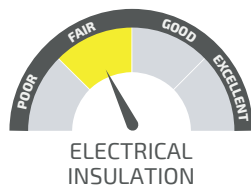

\*continuously (20.000H)

## PLATES

THICKNESS (mm)	TOLERANCE (mm) <sup>(1)</sup>	KG/PIECE <sup>(2)</sup>	NATURAL
Standard size 620 x 3000 mm <sup>(3)</sup>			
15	+0.3 +1.5	37.65	●
18		44.55	○
20		49.20	●
25		60.75	●
30	+0.5 +2.5	74.25	◐
40		97.50	◐
50		120.75	◐
Other standard sizes 1000 mm <sup>(3)</sup>			

(1): tolerances according to DIN EN 15860  
(2): average weights of production  
(3): tolerances in length -0 / + 3%

## ROUND RODS

DIAMETERS (mm)	TOLERANCES (mm) <sup>(1)</sup>	KG/PIECE <sup>(2)</sup>	NATURAL
Standard length 3000 mm <sup>(3)</sup>			
6	+0.1 +0.4	0.11	○
8	+0.1 +0.5	0.20	○
10		0.30	◐
12		0.45	○
16	+0.2 +0.9	0.79	○
20	+0.2 +1.2	1.21	●
22		1.48	○
25		1.89	○
28		2.37	○
30		2.70	●
32		3.06	○
36		3.90	○
40	+0.2 +1.6	4.80	●
45	+0.3 +2.0	6.12	○
50		7.50	●
56		9.36	○
60	+0.3 +2.5	10.83	●
65		12.66	○
70		14.64	○
75	+0.4 +3.0	16.89	○
80		19.17	●
90	+0.5 +3.4	24.27	○
100	+0.6 +3.8	29.97	○
110	+0.7 +4.2	36.30	○
120	+0.8 +4.6	43.20	●
125	+0.9 +5.4	46.80	○
130		50.85	○
140		58.80	○
150	+1.0 +5.8	67.50	○
160	+1.1 +6.3	76.95	○
170	+1.2 +7.4	87.15	○
180		97.50	○
190	+1.3 +8.5	109.05	○
200		120.45	○
Other standard lengths 1000 mm <sup>(3)</sup>			

(1): tolerances according to DIN EN 15860  
(2): average weights of production  
(3): tolerances in length -0 / + 3%

### CAUTION WHEN USED IN:

- Wear applications (low wear resistance and high coefficient of friction, typical for an unfilled/unreinforced amorphous material)
- Applications in water temperature above 65°C in continuous service (due to limited hydrolysis resistance)
- Operations in alkaline media
- Outdoor applications (moderate resistance to UV rays)

● Standard; generally available from stock  
◐ Semi-standard; generally not available from stock  
○ Non-standard; generally not available from stock, manufactured to order and subject to special conditions



# PC TECHNICAL DATASHEET

PROPERTIES	TEST METHODS	UNITS	PC 1000
COLOR		-	TRANSLUCENT
DENSITY	ISO 1183-1	g/cm <sup>3</sup>	1.20
WATER ABSORPTION			
AFTER 24/96H IMMERSION IN WATER OF 23°C <sup>1</sup>	ISO 62	mg	13/23
AFTER 24/96H IMMERSION IN WATER OF 23°C <sup>1</sup>	ISO 62	%	0.18/0.33
AT SATURATION IN AIR OF 23°C / 50% RH	-	%	0.15
AT SATURATION IN WATER OF A 23°C	-	%	0.40
<b>THERMAL PROPERTIES<sup>2</sup></b>			
MELTING TEMPERARUTE (DSC, 10°C/MIN)	ISO 11357-1/-3	°C	-
GLASS TRANSITION TEMPERATURE (DSC, 20°C/MIN) <sup>3</sup>	ISO 11357-1/-3	°C	150
THERMAL CONDUCTIVITY A 23°C	-	W/(K.m)	0.21
COEFFICIENT OF LINEAR THERMAL EXPANSION			
AVERAGE VALUE BETWEEN 23-60°C	-	M/(m.K)	65 x 10 <sup>-6</sup>
AVERAGE VALUE BETWEEN 23-100°C	-	M/(m.K)	65 x 10 <sup>-6</sup>
TEMPERATURE OF DEFLECTION UNDER LOAD			
METHOD A 1.8 MPA	+ ISO 75-1/-2	°C	130
MAXIMUM ALLOABLE SERVICE TEMPERATURE IN AIR			
FOR SHORT PERIODS <sup>4</sup>	-	°C	135
CONTINUOUSLY: FOR 5.000/20.000H <sup>5</sup>	-	°C	130/120
MINIMUM SERVICE TEMPERATURE <sup>6</sup>	-	°C	-50
FAMMABILITY <sup>7</sup>			
"OXYGEN INDEX"	ISO 4589-1/-2	%	25
ACCORDING TO UL94 (3/6MM DE ESPESSURA)	-	-	HB/HB
<b>MECHANICAL PROPERTIES AT 23°C<sup>8</sup></b>			
TENSION TEST <sup>9</sup>			
TENSILE STRESS AT YIELD/AT BREAK <sup>10</sup>	+ ISO 527-1/-2	MPa	74/-
TENSILE STRESS AT YIELD/AT BREAK <sup>10</sup>	++ ISO 527-1/-2	MPa	74/-
TENSILE STRENGTH <sup>10</sup>	+ ISO 527-1/-2	MPa	74
TENSILE STRAIN AT YIELD <sup>10</sup>	+ ISO 527-1/-2	%	6
TENSILE STRAIN AT BREAK <sup>10</sup>	+ ISO 527-1/-2	%	> 50
TENSILE STRAIN AT BREAK <sup>10</sup>	++ ISO 527-1/-2	%	> 50
TENSILE MODULUS OF ELASTICITY <sup>11</sup>	+ ISO 527-1/-2	MPa	2400
TENSILE MODULUS OF ELASTICITY <sup>11</sup>	++ ISO 527-1/-2	MPa	2400
COMPRESSION TEST <sup>12</sup>			
COMPRESSIVE STRESS AT 1/2/5% NOMINAL STRAIN <sup>11</sup> +	ISO 604	MPa	21/40/80
CHARPY IMPACT STRENGTH - UNNOTCHED <sup>13</sup>	+ ISO 179-1/1eU	KJ/m <sup>2</sup>	NO BREAK
CHARPY IMPACT STRENGTH - NOTCHED	+ ISO 179-1/1eA	KJ/m <sup>2</sup>	9
BALL IDENTATION HARDNESS <sup>4</sup>	+ ISO 2039-1	N/mm <sup>2</sup>	120
ROCKWELL HARDNESS <sup>14</sup>	+ ISO 2039-2	-	M 75
<b>ELECTRICAL PROPERTIES AT 23°C</b>			
ELECTRIC STRENGTH <sup>15</sup>	+ IEC 60243-1	kV/mm	28
ELECTRIC STRENGTH <sup>15</sup>	++ IEC 60243-1	kV/mm	28
VOLUME RESISTIVITY	+ IEC 60093	Ohm.cm	> 10 <sup>14</sup>
VOLUME RESISTIVITY	++ IEC 60093	Ohm.cm	> 10 <sup>14</sup>
SURFACE RESISTIVITY	+ IEC 60093	Ohm	> 10 <sup>13</sup>
SURFACE RESISTIVITY	++ IEC 60093	Ohm	> 10 <sup>13</sup>
RELATIVE PERMITTIVITY $\epsilon_r$ : A 100HZ	+ IEC 60250	-	3
RELATIVE PERMITTIVITY $\epsilon_r$ : A 100HZ	++ IEC 60250	-	3
RELATIVE PERMITTIVITY $\epsilon_r$ : A 1MHZ	+ IEC 60250	-	3
RELATIVE PERMITTIVITY $\epsilon_r$ : A 1MHZ	++ IEC 60250	-	3
DIELECTRIC DISSIPATION FACTOR TAN $\delta$ : A 100HZ	+ IEC 60250	-	0.001
DIELECTRIC DISSIPATION FACTOR TAN $\delta$ : A 100HZ	++ IEC 60250	-	0.001
DIELECTRIC DISSIPATION FACTOR TAN $\delta$ : A 1MHZ	+ IEC 60250	-	0.008
DIELECTRIC DISSIPATION FACTOR TAN $\delta$ : A 1MHZ	++ IEC 60250	-	0.008
COMPARATIVE TRACKING INDEX (CTI)	+ IEC 60112	-	350 (225)
COMPARATIVE TRACKING INDEX (CTI)	++ IEC 60112	-	350 (225)

+: values for dry material

++: values referring to material in equilibrium with the standard atmosphere 23°C / 50% rh

(1) According to method 1 of ISO 62 and measured on  $\phi$  50x3 mm discs. (2) The elements supplied for this property are for the most part supplied by the manufacturers of the raw materials. (3) The values of this property are only attributed to amorphous rather than semi-crystalline materials. (4) Only for short periods of exposure in applications where only very low loads are applied to the material. (5) Temperature that resists after a period of 5,000 / 20,000 hours. After this time, there is a decrease of about 50% in tensile strength compared to the original value. The given temperature values are based on the thermal oxidation degradation which occurs which causes a reduction of the properties. In the meantime, the maximum permissible service temperature depends in many cases essentially on the deduction and magnitude of the mechanical stresses to which the material is subject. (6) As the impact strength decreases with decreasing temperature, the minimum allowable service temperature is determined by the extent of impact to which the material is subjected. The values given are based on unfavorable impact conditions and can not therefore be considered absolute limits.

(7) These assessments derive from the technical specifications of the manufacturers of the raw materials and do not allow the determination of the behavior of the materials under fire conditions. (8) Most of the figures given by the properties of the (+) materials are mean values of the tests done on species machined with  $\phi$  40-60 mm. (9) Specimen testing: Type 1b. (10) Speed test: 5 or 50 mm / min. (11) Speed test: 1m / min. (12) Testing specimens: cylinders  $\phi$  8 x 16 mm. (13) Pendulum used: 15J. (14) Test on 10 mm thick specimens. (15) Electrode configuration: cylinders  $\phi$  25 /  $\phi$  75 mm, in transformer oil according to IEC 60296.

Note that the electrical force for the extruded black material can be considerably lower than that of natural material. The possible micro porosity in the center of conserved forms in stock significantly reduces the electric force.

NOTE: 1 g/cm<sup>3</sup> = 1000 kg/m<sup>3</sup> ; 1 MPa = 1 N/mm<sup>2</sup> ; 1 KV/mm = 1 MV/m

# MAXIMUM ALLOWABLE SERVICE TEMPERATURE IN AIR

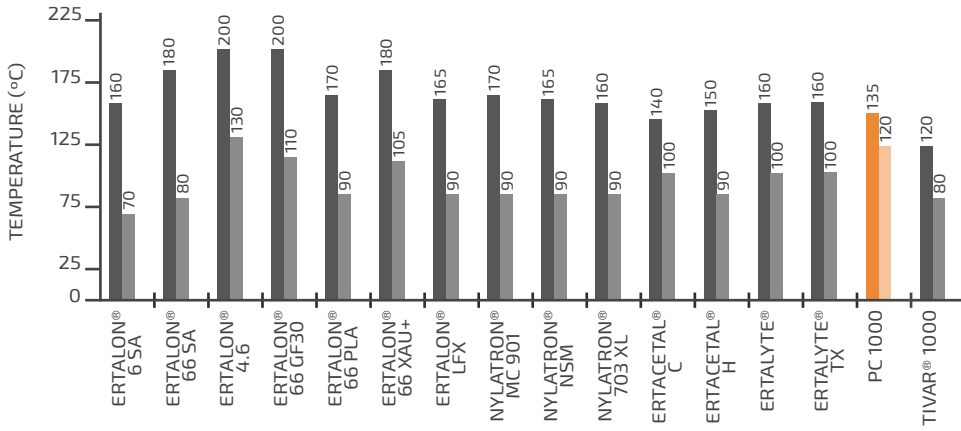

**CAPTION**

- MAXIMUM SERVICE TEMPERATURE CONTINUOUSLY
- MAXIMUM SERVICE TEMPERATURE FOR SHORT PERIODS

# RIGIDITY vs. TEMPERATURE

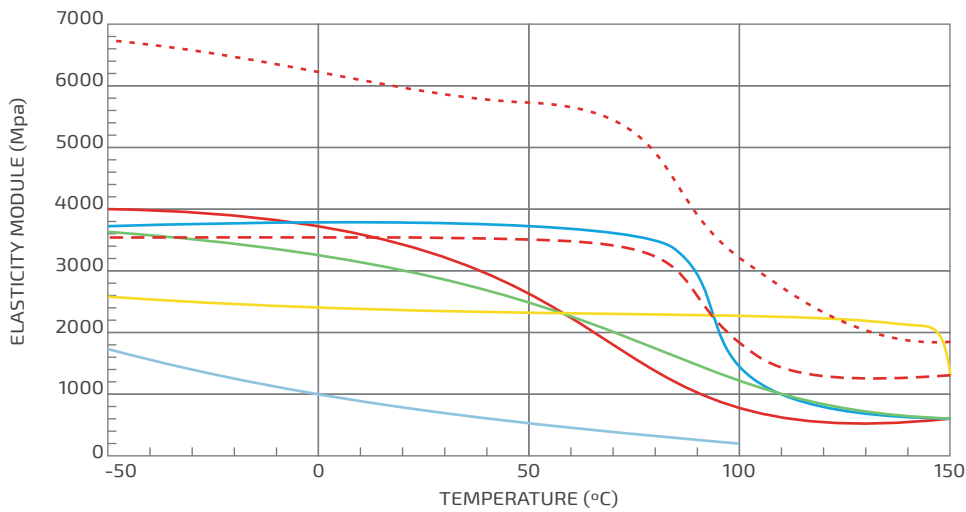

**CAPTION**

- ERTALON® 6 PLA (SECO)
- ERTALON® 4.6 (SECO)
- ERTALON® 66 GF30 (SECO)
- ERTACETA®L® C
- ERTALYTE
- PC 1000
- TIVAR® 1000



# PC DIMENSIONAL STABILITY

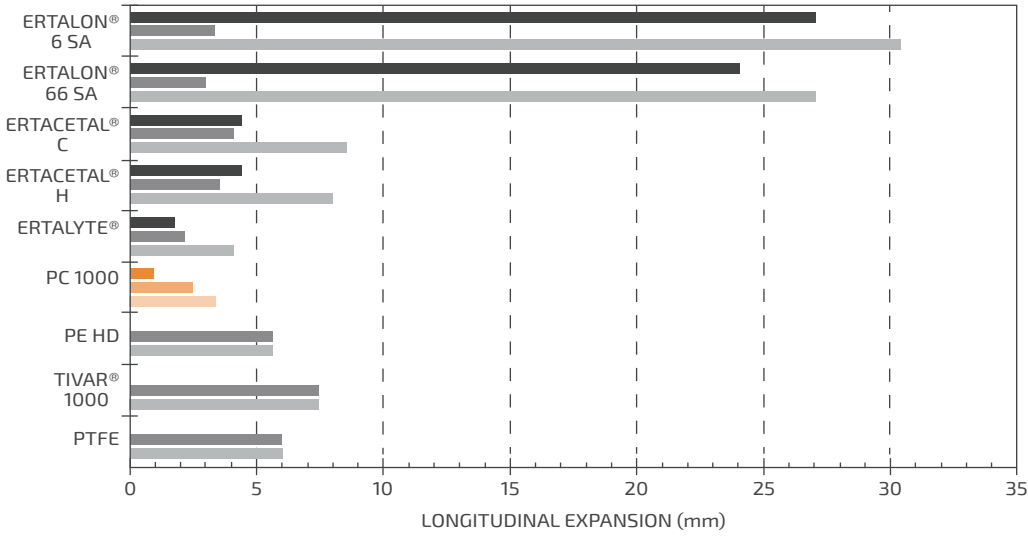

**TEST CONDITIONS**  
- Expansion of a long strip of 1,000mm (dry, 23°C) when immersed in water at 60°C

**CAPTION**

- Expansion caused by the absorption of water in complete saturation
- Expansion caused by the increase in temperature from 23°C to 60°C
- Total expansion

# TENSILE STRESS ON ELASTIC LIMIT STRESS/RUPTURE\* AT 23°C (ISO 527)

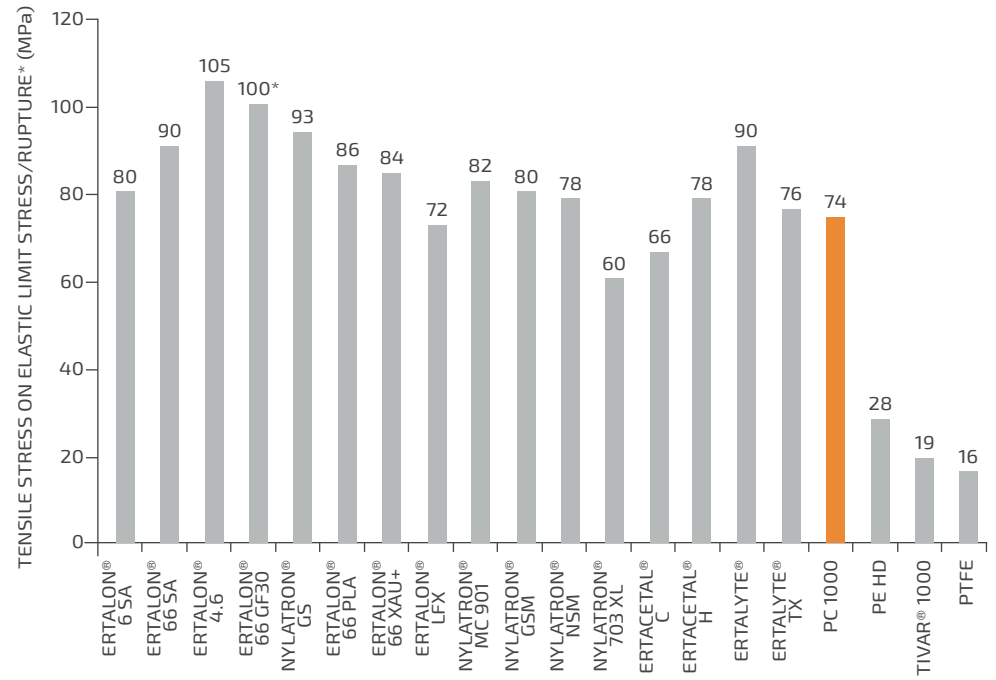

**TEST CONDITIONS**  
- Measured on dry samples

PC 1000

# WEAR RESISTANCE AT 23°C

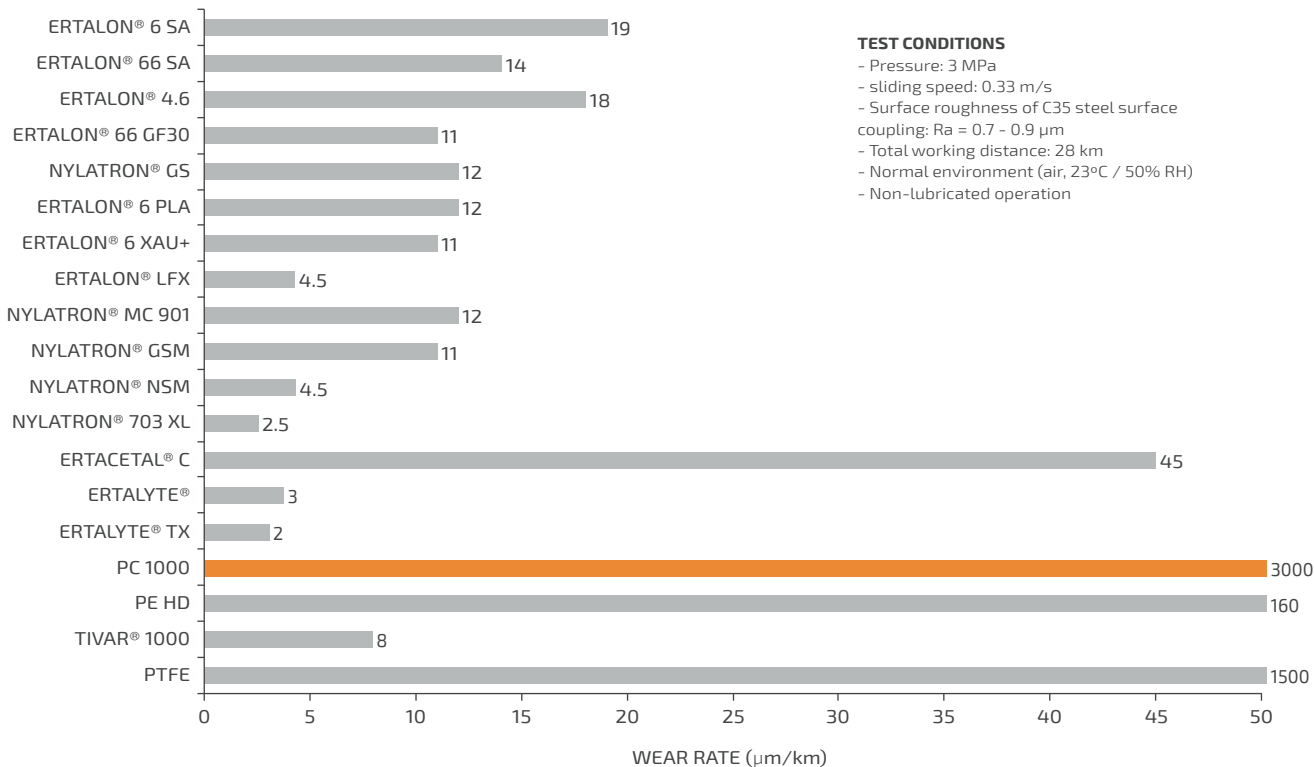

# ROCKWELL HARDNESS M AT 23°C (ISO 2039-2)

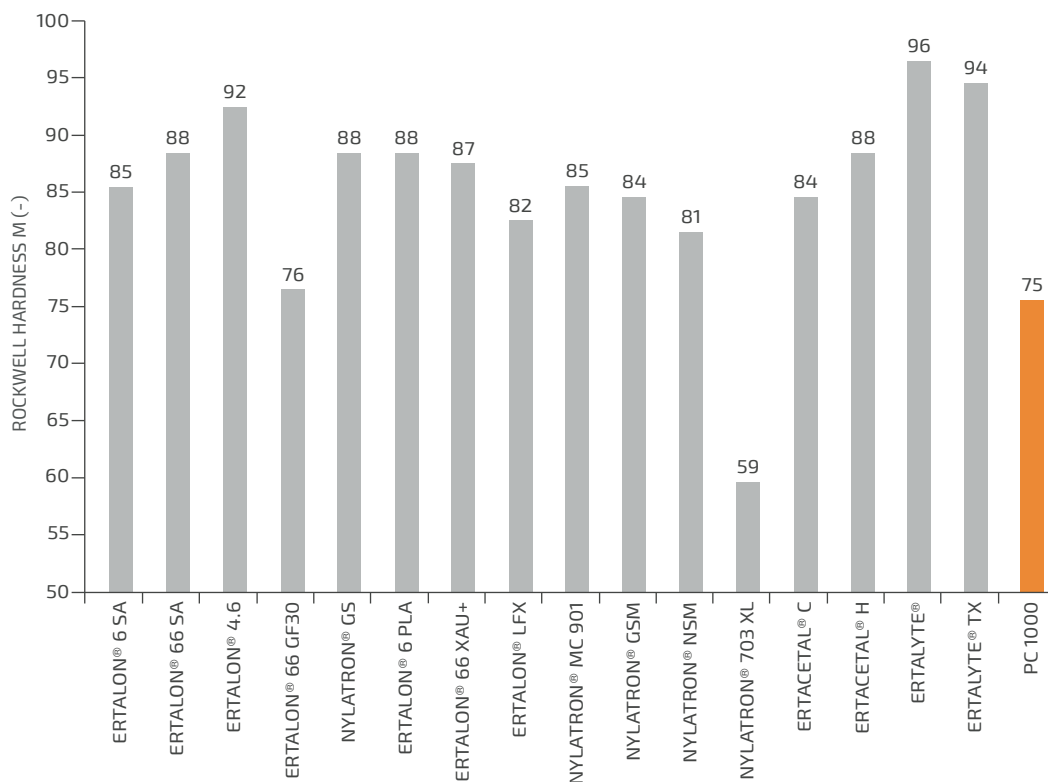





# DYNAMIC FRICTION COEFFICIENT AT 23°C

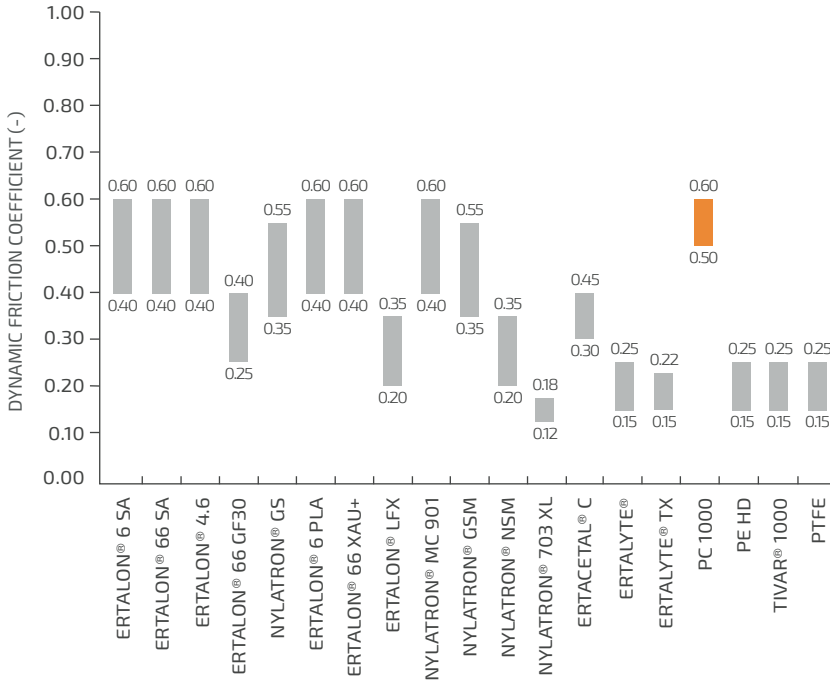

**TEST CONDITIONS**

- Pressure: 3 MPa
- sliding speed: 0.33 m/s
- Surface roughness of C35 steel surface coupling: Ra = 0.7 - 0.9 µm
- Total working distance: 28 km
- Normal environment (air, 23°C / 50% RH)
- Non-lubricated operation

# SUNLIGHT RESISTANCE (UV RAYS)

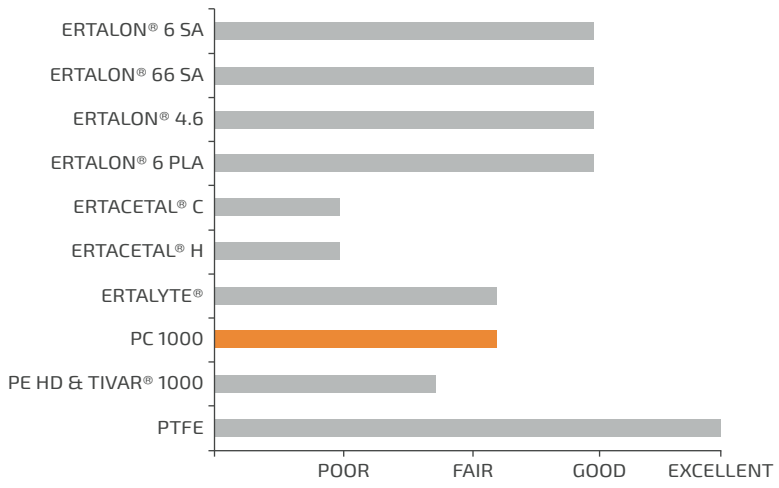

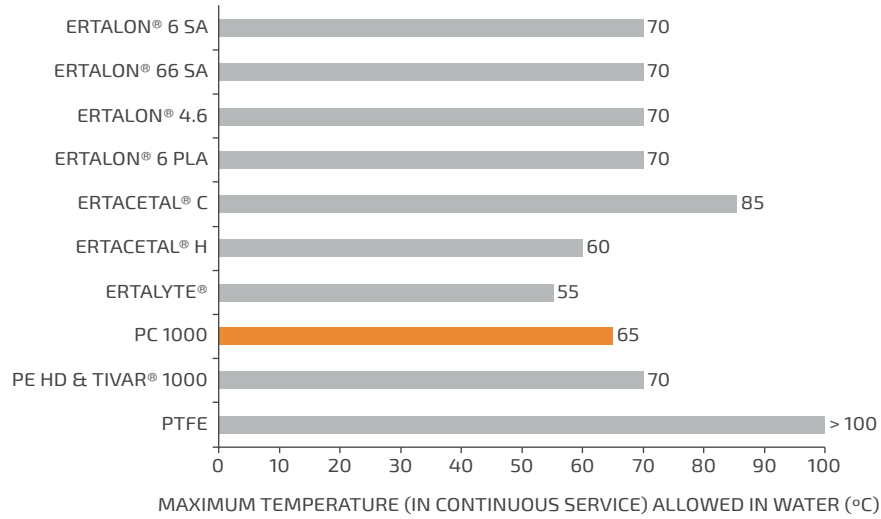

## RESISTANCE AGAINST IONIZING RADIATION (GAMA RAYS)

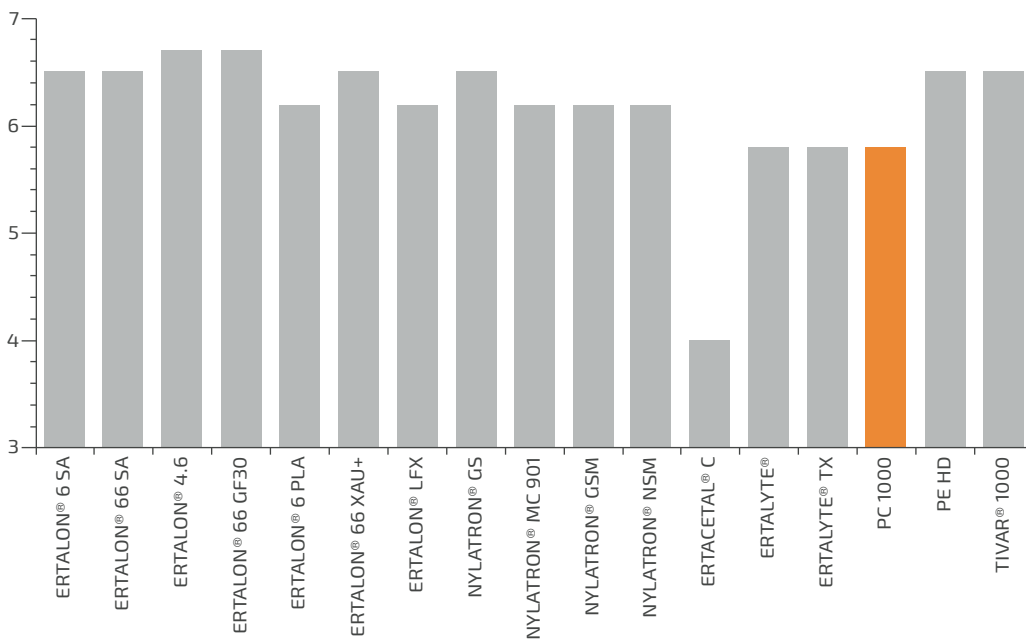

1 Gray = 100 Rad  
10<sup>6</sup> Gray = 100 Mrad  
1 Mrad = 10 kJ/kg

The radiation index (RI) is defined as the logarithm, base 10, of the dose absorbed in the GRAY in which the flexural stress at rupture or flexural tension at rupture of the tested material is reduced to 50% of its original value under irradiation conditions (the most sensitive to radiation)





# GENERAL USE PLASTICS

Polypropylene Natural		176
Polypropylene Grey		177
Polyurethane		180
PVC		182
TPE		184
PTFE		186
Technical Data		190



# POLYPROPYLENE NATURAL



This material is the lightest of all thermoplastics (density of 0.90 g/cm<sup>2</sup>). At room temperature, it withstands virtually any type of chemical attack and at temperatures around 70°C does not become vulnerable to chemical agents. Easy transformation with all types of tools used for wood and those used for metals. They are plastics with a high level of recycling and with low impact on the environment. To achieve more hardness or abrasion resistance, this material must be reinforced with Glass Fibre (PP-GF) filler.

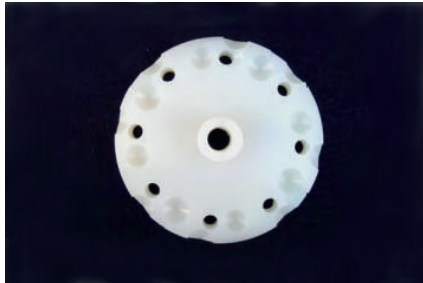

## MAIN CHARACTERISTICS

- Permanent heat stability
- High chemical resistance
- High resistance to corrosion
- Good long-term properties when compared to other similar materials
- High rigidity at high temperatures

## APPLICATIONS

- Chemical facilities
- Pharmaceutical industry and bioindustry
- Agriculture and livestock
- Aquaculture

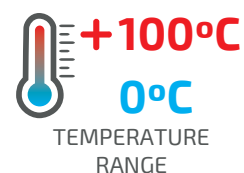
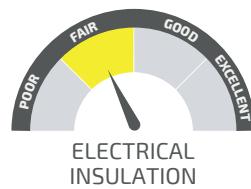



# POLYPROPYLENE GREY

Polypropylene Grey has been improved with special heat stabilizers to increase the material's life. This was first used in tanks and coatings for the chemical and semi-conductor industries. Together with the inherent properties of corrosion resistance, this product can last for more than 50 years compared to the standard values of Natural Polypropylene that has a life time of only 5 to 10 years in the same applications. Even at normal working temperatures, Gray Polypropylene is highly recommended. The small difference in cost, compared to lower quality products, is more than compensatory due to the considerable increase in the life time of this product.



## MAIN CHARACTERISTICS

- Permanent heat stability
- High chemical resistance
- Good long-term properties when compared to other similar materials
- High rigidity at high temperatures
- Excellent for use in construction of chemical tanks and equipment

## APPLICATIONS

- Civil engineering
- Chemical facilities
- Pharmaceutical industry and bioindustry
- Livestock and agriculture
- Aquaculture
- Construction of swimming pools
- Food production
- Mining

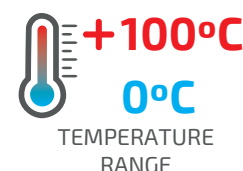
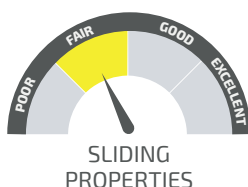
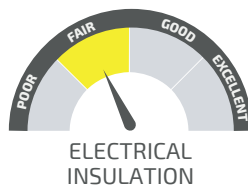





**SHEETS**

THICKNESS (mm)	PP NATURAL	PP GREY
Standard size 1000 x 2000 mm		
1	●	●
2	●	●
3	●	●
4	●	●
5	●	●
6	●	●
Standard size 1500 x 3000 mm		
2	●	●
3	●	●
4	●	●
5	●	●
6	●	●

Weights and tolerances on request



PRECISION MACHINING SERVICES  
**AT YOUR DISPOSAL!**

- Standard: generally available from stock
- ◐ Semi-standard: generally not available from stock
- Non-standard: generally not available from stock, manufactured to order and subject to special conditions

**PLATES**

THICKNESS (mm)	PP NATURAL	PP GREY
Standard size 1000 x 2000 mm		
8	●	●
10	○	●
12	○	●
15	○	●
20	○	●
25	○	○
30	○	○
35	○	○
40	○	○
Standard size 1500 x 3000 mm		
8	○	○
10	○	○
12	●	○
15	●	○
20	●	○
25	●	○
30	○	○
35	○	○
40	○	○

Weights and tolerances on request

**THINKING OF YOU, WE CUT THE MATERIALS TO YOUR MEASURE!**



● Standard: generally available from stock  
 ○ Semi-standard: generally not available from stock  
 ○ Non-standard: generally not available from stock, manufactured to order and subject to special conditions



# POLYURETHANE

Synthetic material with elasticity like that of the rubber but with exceptional mechanical and resistance properties, which give the pieces a longer life. Polyurethane fills the space between technical plastics and rubber by combining hardness, elasticity and mechanical resistance.



## MAIN CHARACTERISTICS

- It is applied in parts subjected to very hard work requirements, in which a special one is required:
  - Resistance to wear and abrasion
  - Elasticity
  - Load capacity
  - Mechanical resistance
  - Damping

## APPLICATIONS

- Wheels, rollers
- Gaskets
- Elastic couplings
- Suckers
- Elevator guides
- In general, any part subjected to wear by friction, bending or load

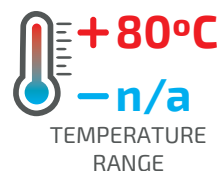
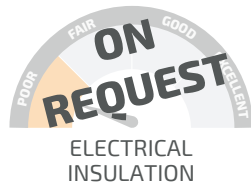



### SHEETS

THICKNESS (mm)	STOCK
<b>Size 500 x 3000 mm</b>	
1	●
2	●
3	●
4	●
POLY 5	●
6	●
7	●
<b>Size 1000 x 1000 mm</b>	
2	●
3	●
4	●
5	●
6	●
7	●

Tolerances on request.  
 Other measures under consultation.

### PLATES

THICKNESS (mm)	STOCK
<b>Tamanho 500 x 3000 mm</b>	
8	●
9	●
10 <sup>POLY</sup>	●
12	●
<b>Tamanho 1000 x 1000 mm</b>	
8	●
10	●
12	●
15 <sup>POLY</sup>	●
20	●

Tolerances on request.  
 Other measures under consultation.

### TUBES

DIAMETER (mm)	STOCK
<b>Length 250 mm</b>	
15 x 20	●
15 x 25	●
15 x 30	●
15 x 35	●
17 x 63	●
20 x 30	●
20 x 40	●
30 x 40	●
POLY 30 x 45	●
30 x 50	●
30 x 60	●
30 x 80	●
40 x 50	●
40 x 70	●
40 x 100	●
50 x 60	●
50 x 80	●
50 x 100	●
85 x 100	●

Tolerances on request.  
 Other measures under consultation.

### ROUND RODS

DIAMETER (mm)	STOCK
<b>Length 250 mm</b>	
10	●
12	●
15*	●
16	●
18	●
20	●
22	●
25	●
30	●
32	●
35	●
POLY 40	●
45	●
50	●
55	●
60	●
65	●
70	●
75	●
80	●
85	●
90	●
100	●
110	●
120	●
125	●
127	●
150	●

\* Also available with 200 mm in length.  
 Tolerances on request.

● Standard; generally available from stock  
 ● Semi-standard; generally not available from stock  
 ○ Non-standard; generally not available from stock, manufactured to order and subject to special conditions



# PVC

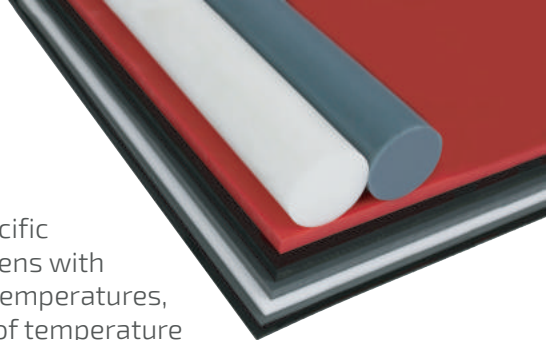

**Amorphous plastic**, of a rigid mass, physiologically nontoxic and with specific weight 1.44 g/cm<sup>3</sup>. As all thermoplastics, it hardens with the cold and softens with the heat. For this reason, its mechanical resistance increases even at low temperatures, and its impact resistance decreases. It should be noted that the influence of temperature is almost nil up to 40°C. However, when the temperature is kept between 40°C and 60°C, the rigid PVC can be used in several applications, always considering that the pressures and mechanical loads they support are lower than the normal ones. At temperatures below 0° C, the material must be protected against impact.



## MAIN CHARACTERISTICS

- Excellent chemical resistance
- UV resistant
- Resistant to adverse weather conditions
- High stiffness
- Used in the construction of tanks and chemical equipment

## APPLICATIONS

- Construction
- Chemical facilities
- Pharmaceutical industry and bioindustry
- Agriculture and livestock
- Construction of swimming pools
- Food production



CHEMICAL RESISTANCE



ELECTRICAL INSULATION



WEAR RESISTANCE



SLIDING PROPERTIES



IMPACT RESISTANCE

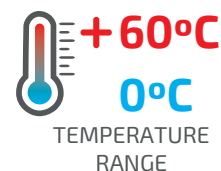

TEMPERATURE RANGE



**SHEETS**

THICKNESS (mm)	GREY
<b>1500 X 3000 mm</b>	
1	●
1.5	●
2	●
3	●
4	●
5	●
6	●
<b>1000 X 2000 mm</b>	
1	●
1.5	●
2	●
3	●
4	●
5	●
6	●

Weights and tolerances on request.

**PLATES**

THICKNESS (mm)	GREY	BLACK	RED
<b>Standard size 1500 X 3000 mm</b>			
8	○	-	-
10	○	-	-
12	○	-	-
15	○	-	-
20	○	-	-
25	○	-	-
30	○	-	-
35	○	-	-
40	○	-	-
<b>Standard size 1000 X 2000 mm</b>			
8	●	-	-
10	●	●	-
12	●	-	●
15	●	-	-
20	●	-	●
25	●	-	-
30	●	-	-
35	●	-	-
40	●	-	-
50	●	-	-
60	●	-	-
80	○	-	-
90	○	-	-
100	○	-	-

Weights and tolerances on request.

**ROUND RODS**

DIAMETERS (mm)	GREY	RED
<b>Standard length 2000 mm</b>		
4	○	-
5	●	-
6	○	-
8	●	-
10	●	-
12	●	-
14	●	-
15	●	-
16	○	-
18	●	-
20	●	-
22	○	-
25	○	-
28	●	-
30	●	-
35	●	○
40	●	-
45	●	-
50	●	-
55	○	-
60	●	-
65	●	-
70	●	-
75	●	-
80	●	-
90	●	-
95	●	-
100	●	-
110	●	-
120	●	-
130	●	-
140	●	-
150	●	-
200	●	-
<b>Standard length 1000 mm</b>		
160	●	-
180	●	-
<b>Standard length 500 mm</b>		
250	●	-
300	●	-

Weights and tolerances on request.

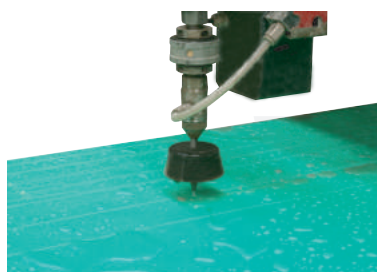

**REDUCE YOUR COSTS WITH OUR WATER JET CUTTING SERVICE!**

● Standard; generally available from stock  
 ○ Semi-standard; generally not available from stock  
 ○ Non-standard; generally not available from stock, manufactured to order and subject to special conditions





# TPE

Quadrant® TPE combines the resistance and processing characteristics of engineering plastics with the dynamic performance of thermoset elastomers. Compared to other elastomers, polyester-based materials offer more consistent operating performance. It is characterized by its high elasticity and mechanical properties at high and low temperatures.



## MAIN CHARACTERISTICS

- Properties consistent over a wide range of temperatures: - 40°C to 80°C
- Excellent flexural fatigue resistance at high and below zero temperatures
- Extreme toughness
- High creep resistance
- Impact resistance
- Elasticity and resilience (e.g. compression assembly)
- Very good general chemical resistance: industrial chemicals and solvents, gasoline, grease, oils, etc.
- Very high energy absorption

## APPLICATIONS

- Dampers
- Ship deck pads
- Springs (e.g.: Springs for wagons - railway)
- Gears
- Wheels
- Bumpers
- Polyurethane/steel and rubber/steel substitute

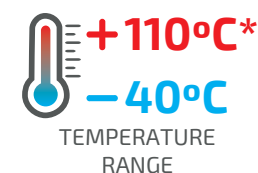
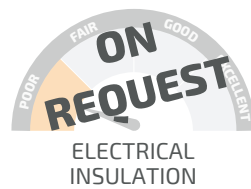
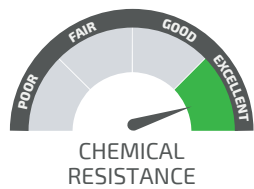

\*continuously (20.000H)



### PLATES

THICKNESS (mm)	DIMENSIONS (mm)	DIMENSIONS (mm)
8 - 80	610 x 1000	610 x 3000

Other thicknesses available on request.

### ROUND RODS

DIAMETERS (mm)	LENGTH (mm)
80 - 120	3000

Other diameters available on request.

VERSATILITY AND AVAILABILITY IN  
THE MANUFACTURING OF **LARGE  
AND COMPLEX PARTS.**

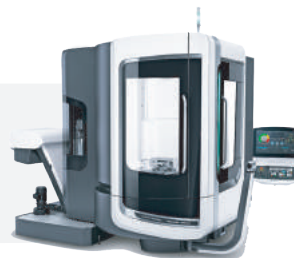



# PTFE

PTFE stands out for its flame resistance: it is classified as a "non-combustible" material in the air according to ASTM D365 test method. This material has low resistance to gamma radiation: for example, an exposure to 70 Megarads reduces the tensile strength by 50%. It has good mechanical properties, even at very low temperatures and excellent fatigue resistance, especially in applications involving bending or vibration.

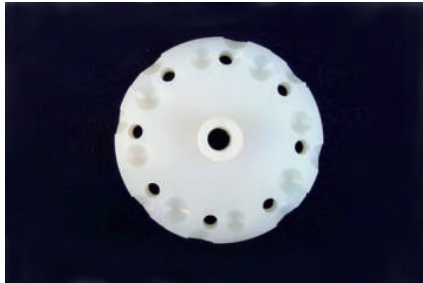

## MAIN CHARACTERISTICS

- Wide range of temperatures -200°C to +260°C
- Almost total resistance to all chemicals
- Very low coefficient of friction
- Non-flammable
- Excellent dielectric properties
- Good mechanical properties
- Excellent resistance to fatigue
- Total resistance to ageing, moisture and ultraviolet rays
- Non-toxic

## APPLICATIONS

- Permeability
- Friction
- Electrical insulation
- Anti-corrosion
- General mechanics

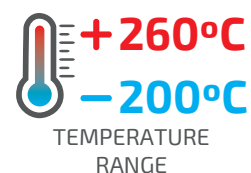
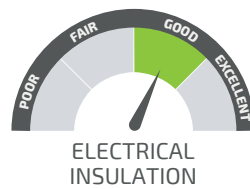
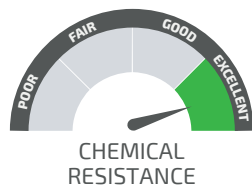

# PTFE WITH LOADS

The advantages of filled PTFE compounds compared to uncharged resins are the properties of the filler formula, i.e. the properties of the added material. For example, the wear resistance may be more than 1,000 times greater than that of virgin PTFE. Other advantages include improving the initial deformation resistance and flowability, increasing stiffness and dimensional stability with temperature and a slight increase in hardness.

## PTFE + Carbon Graphite

Usually used for chemical and mechanical applications. Graphite decreases initial wear and strengthens PTFE compound. PTFE + Graphite has high thermal conductivity and high wear resistance at high loads. Recommended for piston seals and other dynamic seals.

## PTFE + Glass Fibre

It is the most used filler and the filler that modifies the least the PTFE chemical and electrical properties improving the mechanical characteristics in a unique way. It slightly increases the coefficient of friction as it considerably increases the wear resistance and at high loads. Recommended for structural parts and sealing balls.

## PTFE + Bronze

Bronze fillers improve wear resistance characteristics of parts subjected to abrasion, combining low coefficient of friction with resistance to high loads. Using high percentages, we can obtain a product with good thermal conductivity and higher mechanical properties than the other compounds. This material is not recommended in electrical applications because it is not an electrical insulator. Recommended for sliding and rotating applications.

## PTFE + Molybdenum Disulphide

It has the same resistance to high loads but uses MoS<sub>2</sub> as a lubricant. Thanks to this filler, PTFE hardness, stiffness and wear resistance are considerably improved and its influence on thermal and electrical properties is almost non-existent.

## THERMAL AND MECHANICAL PROPERTIES

PROPERTIES	RULES	UNITS	VIRGIN PTFE	PTFE +						
				GRAPHITE 15	CARBON 25	GLASS 15	GLASS 25	BRONZE 60	CARBON 22 GRAPHITE 3	GLASS 15 MOS <sub>2</sub> 5
DENSITY	ISO 12086	g/cm <sup>3</sup>	2.14-2.18	2.15-2.18	2.08-2.12	2.18-2.20	2.20-2.24	3.85-3.95	2.06-2.11	2.22-2.25
SHORE HARDNESS	DIN 53505	Sh. D	52-60	56-64	62-68	54-62	56-64	63-68	60-69	54-58
TENSILE STRENGTH (23°C)	DIN 53455	N / mm <sup>2</sup>	25-42	12-19	13-15	17-21	15-19	11-15	11-15	14-18
DEFORMATION TO RUTURE (23°C)	DIN 53455	%	250-400	130-240	40-70	250-290	220-260	110-140	60-100	200-230
MODULUS OF ELASTICITY	DIN 53457	N / mm <sup>2</sup>	400-800	720	1150	1000	950	-	1250	750
COMPRESSIVE STRESS AT 1% DEFORMATION (23°C)	DIN 53454	N / mm <sup>2</sup>	4.3	7.3	14	6.9	8.2	13	11	6.9
COEFFICIENT OF THERMAL EXPANSION (20-150°C)	-	1/K.10 <sup>-5</sup>	12	10.5	9	10.5	10	9	8.5	10.2
COEFFICIENT OF THERMAL EXPANSION (150-260°C)	-	1/K.10 <sup>-5</sup>	16	13.9	12	13.6	13.4	12.3	11.6	13.5
THERMAL CONDUCTIVITY (23°C)	DIN 52612	W/K.m	0.23	0.52	0.6	0.39	0.46	0.77	0.54	0.35
DEFORMATION AFTER 24H AT 23°C - 4	ASTM D621	%	16	9	4	13.5	12.5	4.2	6.5	12
DEFORMATION AFTER 24H AT 23°C - 15	ASTM D621	%	7	3.6	1.6	5	4.8	2.8	2.1	5
PV LIMIT 3 m/min	-	N/mm <sup>2</sup> m/min	2.5	21	-	20	23	21	32	25
PV LIMIT 30 m/min	-	N/mm <sup>2</sup> m/min	3.9	26	-	23	25	27	32	28
PV LIMIT 300 m/min	-	N/mm <sup>2</sup> m/min	5.5	27	-	30	31	28	35	32
COEFFICIENT OF STATIC STROKE	-	-	0.14	0.15	-	0.16	0.18	0.17	0.14	0.15
WEAR	-	cm <sup>3</sup> min/kg m h	78	41	-	8.3	7.1	6.1	7	8.1



# GENERAL USE PLASTICS DELIVERY PROGRAM

## SHEETS

THICKNESS (mm)	TOLERANCES	600 x 600	1000 x 1000	1200 x 1200	1500 x 1500	2000 x 1000
1	+0.10 0	●	●	●	●	●
1.5	+0.20 0	●	●	●	●	●
2	+0.30 0	●	●	●	●	●
2.5		●	●	●	●	●
3		●	●	●	●	●
4	+0.35 0	●	●	●	●	●
4.5	+1.00 0	●	●	●	●	●
5		●	●	●	●	●
6	+1.20 0	●	●	●	●	●

## PLATES

THICKNESS (mm)	TOLERANCES	600 x 600	1000 x 1000	1200 x 1200	1500 x 1500	2000 x 1000
8	+1.20 0	●	●	●	●	●
10	+1.50 0	●	●	●	●	●
12	+15% 0	●	●	●	●	●
15		●	●	●	●	●
20		●	●	●	●	●
25		●	●	●	●	●
30		●	●	●	●	●
35		●	●	●	-	-
40		●	●	●	-	●
45		●	●	●	-	-
50		●	●	●	-	●
60		●	●	●	-	-
70	●	●	●	-	-	
80	●	●	●	-	-	
90	●	-	●	-	-	
100	●	-	●	-	-	
110	●	-	-	-	-	
120	●	-	-	-	-	
130	●	-	-	-	-	
140	●	-	-	-	-	
150	●	-	-	-	-	

## ROUND RODS

DIAMETERS (mm)	TOLERANCES	PTFE
Standard length 1000 mm		
4	0 +0.3	●
5		●
6		●
7	0 +0.4	●
8		●
9		●
10		●
11	0 +0.8	●
12		●
13		●
14		●
15		●
16		●
17		●
18		●
19		●
20		●
22	0 +1.2	●
25		●
28		●
30	0 +1.6	●
32		●
35		●
38		●
40	0 +2.0	●
42		●
45		●
50		●
55		●
60	0 +2.4	●
65		●
70		●
75	0 +2.8	●
80		●
85	0 +3.2	●
90		●
100		●
110	0 +4.0	●
120		●
130		●
140		●
150	0 +5.0	●
160		●
170		●
180		●
200		●

Other standard lengths:  
2000 mm (de 4-120 mm thickness)  
3000 mm (de 4-120 mm thickness)

● Standard: generally available from stock  
 ● Semi-standard: generally not available from stock  
 ○ Non-standard: generally not available from stock, manufactured to order and subject to special conditions



**TUBES**

DIAMETERS		TOLERANCES			KG/ METER	PTFE	
O.D.	I.D.	O.D.	I.D.	O.D.			
Standard length 2000 mm							
10	4				0.16	●	
	5	0	+0.5	-0.5	0	0.15	●
	6				0.13	●	
12	6	0	+0.5	-0.5	0	0.21	●
	8				0.18	●	
14	6				0.32	●	
	8	0	+0.5	-0.5	0	0.27	●
	10				0.22	●	
15	6				0.37	●	
	8	0	+0.5	-0.5	0	0.31	●
	10				0.26	●	
16	6				0.43	●	
	8	0	+0.5	-0.5	0	0.38	●
	10				0.31	●	
18	6				0.54	●	
	8	0	+0.5	-0.5	0	0.48	●
	10				0.44	●	
20	6				0.70	●	
	8				0.65	●	
	10	0	+0.5	-0.5	0	0.60	●
22	6				0.73	●	
	8				0.75	●	
	10				0.71	●	
25	6				1.07	●	
	8				1.05	●	
	10				1.02	●	
	12	0	+1.0	-1.0	0	0.95	●
	14				0.88	●	
27	10				1.34	●	
	12				1.08	●	
	15	0	+1.0	-1.0	0	0.90	●
	18				0.78	●	
28	15				1.09	●	
	18	0	+1.0	-1.0	0	0.95	●
	20				0.86	●	
30	8				1.58	●	
	10				1.53	●	
	12				1.46	●	
	14				1.38	●	
	15	0	+1.0	-1.0	0	1.32	●
	18				1.20	●	
	20				1.06	●	
25				0.71	●		

DIAMETER		TOLERANCES			KG/ METER	PTFE	
O.D.	I.D.	O.D.	I.D.	O.D.			
Standard length 2000 mm							
32	10				1.75	●	
	15				1.54	●	
	20	0	+1.5	-1.5	0	1.34	●
	22				1.13	●	
	25				1.03	●	
35	10				2.00	●	
	15				1.89	●	
	18				1.77	●	
	20	0	+1.5	-1.5	0	1.66	●
	22				1.38	●	
38	20				2.10	●	
	25	0	+1.5	-1.5	0	1.56	●
	28				1.39	●	
	30				1.17	●	
	35				1.03	●	
40	10				2.68	●	
	15				2.54	●	
	20	0	+1.5	-1.5	0	2.35	●
	25				1.98	●	
	30				1.56	●	
45	10				3.36	●	
	15				3.23	●	
	20	0	+1.5	-1.5	0	2.93	●
	25				2.69	●	
	30				2.23	●	
50	20				3.97	●	
	25	0	+1.5	-1.5	0	3.50	●
	30				3.10	●	
	35				2.54	●	
	40				1.81	●	
55	20				4.78	●	
	25	0	+2.0	-2.0	0	4.49	●
	30				3.91	●	
	35				3.48	●	
	40				2.85	●	
60	20				5.64	●	
	25	0	+2.0	-2.0	0	5.36	●
	30				5.01	●	
	35				4.50	●	
	40				3.80	●	
65	25				6.65	●	
	30	0	+2.0	-2.0	0	6.30	●
	35				5.83	●	
	40				4.85	●	
	45				4.10	●	
	50				3.54	●	
	55				2.74	●	

DIAMETER		TOLERANCES			KG/ METER	PTFE	
O.D.	I.D.	O.D.	I.D.	O.D.			
Standard length 2000 mm							
70	30				7.25	●	
	35				6.78	●	
	40				5.96	●	
	45	0	+2.0	-2.0	0	5.74	●
	50				4.61	●	
75	55				3.87	●	
	60				2.97	●	
	30				8.53	●	
	35				7.94	●	
	40				7.08	●	
80	45	0	+2.0	-2.0	0	6.55	●
	50				5.77	●	
	55				4.69	●	
	60				4.22	●	
	65				3.23	●	
85	40				8.87	●	
	50				7.04	●	
	55	0	+2.0	-2.0	0	5.43	●
	60				5.32	●	
	65				4.52	●	
90	70				3.32	●	
	50				8.62	●	
	60				8.39	●	
	65	0	+2.0	-2.0	0	5.60	●
	70				5.18	●	
95	75				4.04	●	
	50				10.51	●	
	60				7.22	●	
	65	0	+2.0	-2.0	0	7.06	●
	70				6.26	●	
100	75				4.99	●	
	80				3.99	●	
	50				11.87	●	
	70	0	+2.0	-2.0	0	7.55	●
	80				5.53	●	
105	85				4.20	●	
	50				13.22	●	
	60				12.02	●	
	70	0	+3.0	-3.0	0	10.11	●
	80				7.08	●	
110	85				5.45	●	
	90				4.68	●	
	80	0	+3.0	-3.0	0	8.59	●
	80				10.26	●	
	90	0	+3.0	-3.0	0	7.86	●
120	100				5.47	●	
	80	0	+3.0	-3.0	0	14.02	●
	100				8.84	●	
130	100	0	+3.0	-3.0	0	15.80	●
140	120	0	+3.0	-3.0	0	13.50	●
165	140	0	+3.0	-3.0	0	16.00	●

The indicated weights are for orientation purposes only.

**PTFE WITH LOADS  
ON REQUEST**

● Standard; generally available from stock  
 ● Semi-standard; generally not available from stock  
 ○ Non-standard; generally not available from stock, manufactured to order and subject to special conditions



# GENERAL USE PLASTICS TECHNICAL DATASHEET

PROPERTIES	TEST METHOD	UNITS	TPE
COLOR		-	NATURAL
DENSITY	ISO 1183-1	g/cm <sup>3</sup>	1.20
WATER ABSORPTION			
AFTER 24/96H IMMERSION IN WATER OF 23°C	ISO 62	mg	-
	ISO 62	%	-
AT SATURATION IN AIR OF 23°C / 50% RH	-	%	0.2
AT SATURATION IN WATER OF 23°C	-	%	0.65
<b>THERMAL PROPERTIES</b>			
MELTING TEMPERATURE (DSC, 10°C/MIN)	ISO 11357-1/-3	°C	210
GLASS TRANSITION TEMPERATURE (DSC, 20°C/MIN)	ISO 11357-1/-2	°C	-
THERMAL CONDUCTIVITY AT 23°C	-	W/(K.m)	0.19
COEFFICIENT OF LINEAR THERMAL EXPANSION			
AVERAGE VALUE BETWEEN 23-60°C	-	M/(m.K)	150 x 10 <sup>-6</sup>
TEMPERATURE OF DEFLECTION UNDER LOAD			
METHOD A 1.8 MPA +	ISO 75-1/-2	°C	110
MAXIMUM ALLOWABLE SERVICE TEMPERATURE IN AIR			
FOR SHORT PERIODS	-	°C	170
CONTINUOUSLY: 10.000H	-	°C	110
MINIMUM SERVICE TEMPERATURE	-	°C	-40
FLAMMABILITY			
"OXYGEN INDEX"	ISO 4589-1/-2	%	-
ACCORDING TO UL94 (3/6MM DE ESPESSURA)	-	-	HB
<b>MECHANICAL PROPERTIES AT 23°C</b>			
TENSION TEST			
TENSILE STRESS AT YIELD	ISO 527-1/-2	MPa	21
TENSILE STRENGTH	ISO 527-1/-2	MPa	21
TENSILE STRAIN AT YIELD	ISO 527-1/-2	%	32
TENSILE STRESS AT 5% STRAIN	ISO 527-1/-2	MPa	16
TENSILE STRESS AT 10% STRAIN	ISO 527-1/-2	MPa	19
TENSILE STRESS AT 50% STRAIN	ISO 527-1/-2	MPa	20.5
TENSILE STRESS AT 100% STRAIN	ISO 527-1/-2	MPa	20
TENSILE STRESS AT 300% STRAIN	ISO 527-1/-2	MPa	20.5
TENSILE STRENGTH	ISO 527-1/-2	MPa	21
TENSILE STRAIN AT BREAK	ISO 527-1/-2	%	>400
TENSILE MODULUS OF ELASTICITY	ISO 527-1/-2	MPa	310
FLEXURE TEST			
FLEXURAL STRENGTH	ISO 178	MPa	19
COMPRESSION TEST			
1/2/5/10/20% NOMINAL STRAIN	ISO 604	MPa	3/6/14/21/27
CHARPY IMPACT STRENGTH - UNNOTCHED	ISO 179-1/1eU	KJ/m <sup>2</sup>	s/ RUTURA
CHARPY IMPACT STRENGTH - NOTCHED AT 23°C	ISO 179-1/1eA	KJ/m <sup>2</sup>	55P
CHARPY IMPACT STRENGTH - NOTCHED AT -30°C	ISO 179-1/1eA	KJ/m <sup>2</sup>	25
SHORE HARDNESS D	ISO 868	-	57
<b>ELECTRICAL PROPERTIES AT 23°C</b>			
ELECTRIC STRENGTH	IEC 60243-1	kV/mm	20
VOLUME RESISTIVITY	IEC 60093	Ohm.cm	> 10 <sup>14</sup>
SURFACE RESISTIVITY	ESD STM 11.11	Ohm/SQ.	> 10 <sup>13</sup>
RELATIVE PERMITTIVITY ε <sub>r</sub> : A 1MHz	IEC 60250	-	4
DIELECTRIC DISSIPATION FACTOR TAN δ : A 1MHz	IEC 60250	-	0.04
COMPARATIVE TRACKING INDEX (CTI)	IEC 60112	-	600





PROPERTIES	TEST METHODS	UNITS	PP	PP GREY	PVC
COLOR		-	NATURAL	GREY	DARK GREY
DENSITY	ISO 1183	g/cm <sup>3</sup>	0.90	0.91	1.44
<b>THERMAL PROPERTIES</b>					
COEFFICIENT OF LINEAR THERMAL EXPANSION	ISO 11359-2	K <sup>-1</sup>	1.6 x 10 <sup>-4</sup>	1.6 x 10 <sup>-4</sup>	0.8 x 10 <sup>-4</sup>
MAXIMUM TEMPERATURE	-	°C	100	100	60
MINIMUM TEMPERATURE	-	°C	0	0	0
FLAMMABILITY	DIN 4102	-	NORMAL	NORMAL	BAIXA
<b>MECHANICAL PROPERTIES</b>					
TENSILE STRENGTH AT YIELD	ISO 527	MPa	32	33	58
ELONGATION AT YIELD	ISO 527	%	8	8	4
IMPACT RESISTANCE	ISO 179-1eU	KJ/m <sup>2</sup>	s/ RUTURA	s/ RUTURA	-
IMPACT RESISTANCE - UNNOTCHED	ISO 179	KJ/m <sup>2</sup>	7	9	4
SHORE HARDNESS D	ISO 868	-	70	72	82
<b>ELECTRICAL PROPERTIES</b>					
DIELECTRIC STRENGTH	IEC 60243-1	kV/mm	-	-	39
SURFACE RESISTIVITY	IEC 60093	Ohm	10 <sup>14</sup>	10 <sup>14</sup>	10 <sup>13</sup>

PROPERTIES	UNITS	VIRGIN PTFE	PTFE + 25% CARBON	PTFE + 25% GLASS FIBER	PTFE + 60% BRONZE
DENSITY	g/cm <sup>3</sup>	2.13-2.19	2.10	2.25	3.95
<b>THERMAL PROPERTIES</b>					
THERMAL CONDUCTIVITY	cal/s/cm/°C	5 - 11 x 10 <sup>-4</sup>	15 x 10 <sup>-4</sup>	9.5 x 10 <sup>-4</sup>	17 x 10 <sup>-4</sup>
COEFF. OF LINEAR THERMAL EXPANSION (23°C - 260°C)	°C	10-15 x 10 <sup>-5</sup>	12 x 10 <sup>-5</sup>	15 x 10 <sup>-5</sup>	13 x 10 <sup>-5</sup>
<b>MECHANICAL PROPERTIES</b>					
TENSILE STRENGTH	MPa	25 - 30	>14	>13	>10
RUPTURE DEFORMATION	%	250 - 400	>150	>250	>100
SHORE HARDNESS	SHORE D	55 - 60	63	59	65
DYNAMIC FRICTION COEFFICIENT	-	0.06 - 0.15	0.25	0.30	0.25
FLUENCY	%	-	9	14	8
PRESSURE/VELOCITY FACTOR - P.V. (3.5m/min)	kg/cm <sup>2</sup> x m/s	-	550	460	650
<b>ELECTRICAL PROPERTIES</b>					
VOLUME RESISTIVITY	Ohm x cm	>10 <sup>18</sup>	10 <sup>3</sup>	10 <sup>16</sup>	10 <sup>8</sup>
SURFACE RESISTIVITY	Ohm	>10 <sup>17</sup>	10 <sup>3</sup>	10 <sup>16</sup>	10 <sup>8</sup>

PROPERTIES	RULES	UNITS	POLYURETHANE	
			PLATES	RODS/TUBES
COLOR		-	ORANGE	ORANGE
DENSITY	DIN 53479	g/cm <sup>3</sup>	1.25	1.1
<b>MECHANICAL PROPERTIES</b>				
HARDNESS	DIN 53 505	SHORE A	93 +/- 3	94 +/- 2
RUPTURE DEFORMATION	DIN 53 504	%	575	-
ELASTICITY	DIN 53 512	%	47	65
TENSILE STRENGTH	DIN 53 504	MPa	-	45
WEAR RESISTANCE	DIN 53 515	kN/m	115	75
LOSS OF ABRASION	DIN 53 516	mm <sup>3</sup>	30	40
COMPRESSION AT 70°C/24H	DIN 53517	%	22	20









# COMPOSITES

Baquelite		194
Celeron		196
Tervid EP 155F		198
Tervid EP 180H		199
Mikla 990		200
Technical Data		201



# BAQUELITE

KRAFT paper and phenolic resin-based thermolamine stratified. It has high mechanical properties and ease of machining and cutting. Its electrical properties make it suitable for medium and low voltage insulation.

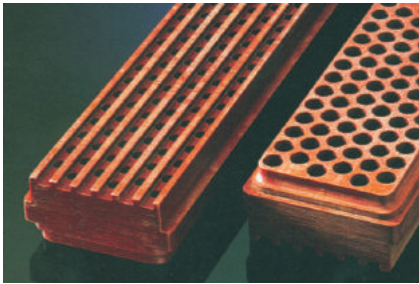
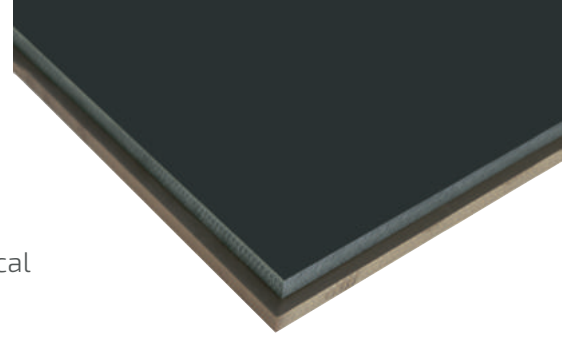

## MAIN CHARACTERISTICS

- Medium dielectric properties
- Excellent electrical insulation
- Good mechanical properties at normal electrical voltages

## APPLICATIONS

- Electrical insulation
- Drilled parts
- Drilling models
- Assembly parts

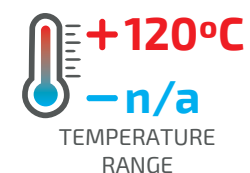
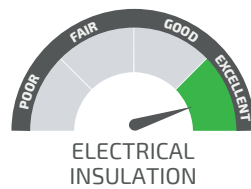

### SHEETS

THICKNESS (mm)	BROWN	BLACK
1240 x 2140 mm		
0.5	●	-
1220 x 2440 mm		
1	-	●
2	-	●
3	-	●
4	-	●
5	-	●
6	-	●

Tolerances on request.

### PLATES

THICKNESS (mm)	BROWN	BLACK
1220 x 2440 mm		
8	-	●
10	-	●
12	-	●
15	-	●
20	-	●
25	-	●
30	-	●
40	-	●

Tolerances on request.

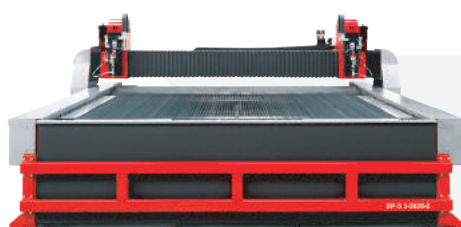

SPECIFIC EQUIPMENT TO ENSURE  
**WATER JET CUTTING INTEGRITY!**

- Standard: generally available from stock
- ◐ Semi-standard: generally not available from stock
- Non-standard: generally not available from stock, manufactured to order and subject to special conditions



# CELERON

Indicated for mechanical applications, CELERON has great resistance to impact and wear, even in harsh conditions such as dusty environments. It is therefore suitable for the construction of elements subjected to heavy loads and wear. It is also a great noise reducer and has a low coefficient of friction. It can be lubricated with water, oil or grease. It is resistant to atmospheric conditions and salt water, being an alternative to materials containing asbestos.



## MAIN CHARACTERISTICS

- Excellent mechanical properties
- High resistance to shock and vibration
- Low wear on parts subjected to continuous friction
- Low coefficient of friction
- Good dimensional stability

## APPLICATIONS

- Cable reel and silent sprockets
- Large loads bushings
- Support and transport rollers
- Electrical Insulation parts
- Vibration Isolator
- Slide plates
- Fuse holder

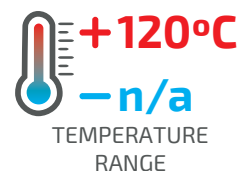
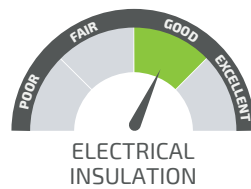

## ROUND RODS

DIAMETERS (mm)	STOCK
Length: 1000 mm	
10	●
15	●
16	○
17	○
18	●
20	●
POLY 25	●
50	●
55	●
60	●
65	●
75	○
Length: 1200 mm	
30	●
35	●
40	●
45	●
POLY 70	●
80	●
90	●
100	●

Tolerances on request.

## PLATES

THICKNESS (mm) <sup>1</sup>	STOCK
1220 x 2440 mm	
8	●
10	●
12	●
15	●
16	●
18	○
20	●
22	●
25	●
30	●
32	○
35	●
40	●
45	●
50	●
1050 x 2050 mm	
60	●
70	●
80	●
1050 x 1250 mm	
100	●
1240 x 2140 mm	
18	●

Tolerances on request.

## SHEETS

THICKNESS (mm) <sup>1</sup>	STOCK
1220 x 2440 mm	
1	●
2	●
3	●
POLY 4	●
5	●
6	●

Tolerances on request.

**PRECISION AND QUALITY  
MACHINING SERVICES!**



● Standard; generally available from stock  
 ○ Semi-standard; generally not available from stock  
 ○ Non-standard; generally not available from stock, manufactured to order and subject to special conditions





# TERVID EP 155F

Laminated stratified material based on glass fibre and epoxy resin, with excellent mechanical and electrical properties due to its excellent dimensional stability (low moisture absorption and low coefficient of thermal expansion) and resistance to high loads. It is the ideal material for electromechanical applications.

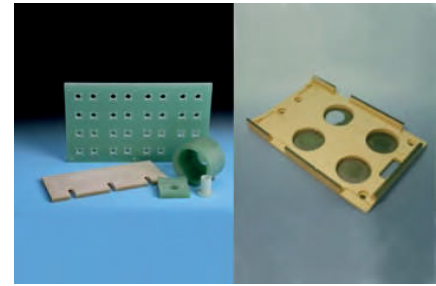
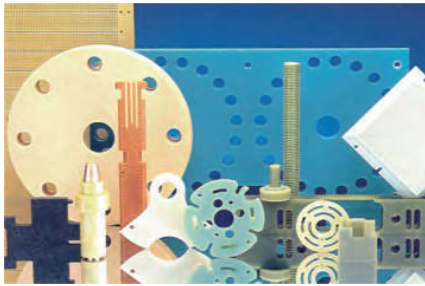
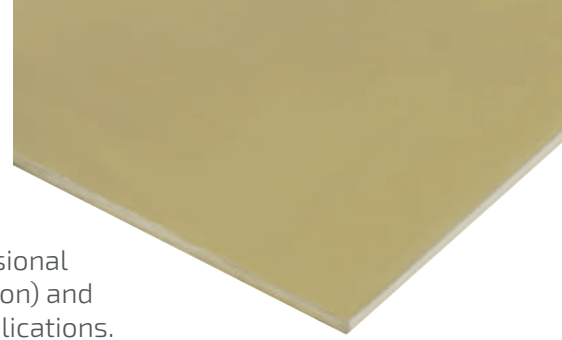

## MAIN CHARACTERISTICS

- High mechanical resistance
- High resistance to fatigue
- Low moisture absorption
- Excellent dielectric properties

## APPLICATIONS

- Elements that support very high dynamic efforts
- High frequency equipment
- High voltage equipment
- Circuit breaker cutting chamber
- Electrical and thermal insulators/separators

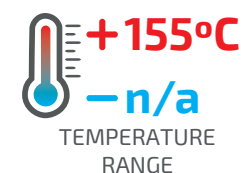
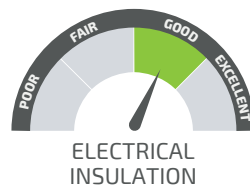

DELIVERY PROGRAM AVAILABLE ON REQUEST

198 | [www.polylanema.pt](http://www.polylanema.pt)

All figures given are indicative only, Polylanema Lda. is not liable for the use of the materials without consulting with our technical department.

# TERVID EP 180H

Quality higher than TERVID EP 155F with a temperature limit of 180°C and class H (CEI). It is an insulating laminate composed of glass fabric bonded with epoxy resin.

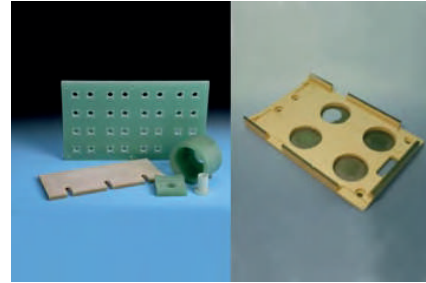
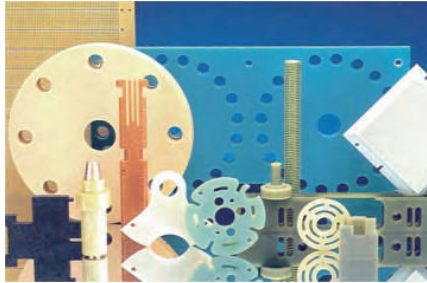

## MAIN CHARACTERISTICS

- Excellent retention of mechanical resistance, even at high temperatures
- Good electrical properties
- High comparative tracking index

## APPLICATIONS

- High frequency equipment
- Elements that support very high dynamic efforts
- Presses and moulds

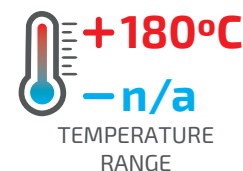
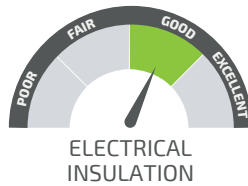

DELIVERY PROGRAM AVAILABLE ON REQUEST

[www.polyanema.pt](http://www.polyanema.pt) | 199



COMPOSITES ●

# MIKLA 990

Mikla 990's low thermal conductivity allows saving energy costs substantially. As a result of low water absorption and chemical stability, there is an increase in the life expectancy of this material. It consists of glass fabric, glass fibre, glass mat and mica paper, as well as to high temperatures resistant resins. It is an asbestos-free product, resistant to high temperatures and has a good mechanical resistance even at high temperatures.

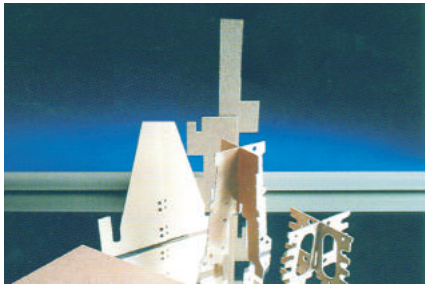
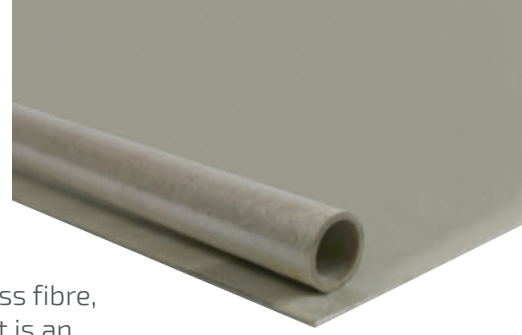

## MAIN CHARACTERISTICS

- Asbestos-free
- Low thermal conductivity
- Easy machining
- Long life expectancy
- Low water absorption
- Good stability of hydro carbonates
- Good chemical stability
- Excellent mechanical durability
- Very good electrical properties

## APPLICATIONS

- Insulation for presses
- Thermal insulation parts
- Insulation of pressure casting machines
- Glass industry
- Cast rubber moulds



CHEMICAL RESISTANCE



ELECTRICAL INSULATION



WEAR RESISTANCE



SLIDING PROPERTIES



IMPACT RESISTANCE

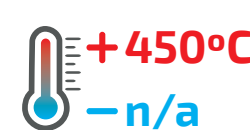

TEMPERATURE RANGE

COMPOSITES

DELIVERY PROGRAM AVAILABLE ON REQUEST

200 | [www.polylanema.pt](http://www.polylanema.pt)

All figures given are indicative only, Polylanema Lda. is not liable for the use of the materials without consulting with our technical department.



PROPERTIES	TEST METHODS	UNITS	BAQUELITE	CELERON	MIKLA 990	TERVID EP180H	TERVID HEP 155F
DENSITY	ISO 1183	g/cm <sup>3</sup>	1.39	1.35	2.22	1.85	1.44
WATER ABSORPTION							
AFTER 24H IMMERSION IN WATER OF 23°C	ISO 62	mg	100	200	-	10	5/11
		%	0.9	1.0	0.2	0.04	5/11
<b>THERMAL PROPERTIES</b>							
TEMPERATURE INDEX (TI)	IEC 60216	°C	120	120	-	180	245
THERMAL CONDUCTIVITY	DIN 52612	W/m.K	0.2	0.2	0.18	0.25	-
COEFFICIENT OF LINEAR THERMAL EXPANSION	VDE 0304	1.0E-6/K	20	18	9	15	0.29
MAXIMUM ALLOWABLE SERVICE TEMPERATURE							
FOR SHORT PERIODS	-	°C	-	-	800	-	65 x 10 <sup>-6</sup>
CONTINUOUSLY	-	°C	-	-	450	-	85 x 10 <sup>-6</sup>
<b>MECHANICAL PROPERTIES AT 23°C<sup>3</sup></b>							
FLEXURAL STRENGTH	ISO 178	MPa	150	120	180	550	76/-
FLEXURAL RESISTANCE AT 150°C/1H	ISO 178	MPa	-	-	-	350	76/-
MODULUS OF ELASTICITY	ISO 178	MPa	8000	6000	-	24000	76/-
CHARPY IMPACT RESISTANCE - NOTCHED	ISO 179	KJ/m <sup>2</sup>	-	10	-	75	76
RESISTANCE TO FLAT COMPRESSION	ISO 604	MPa	-	-	-	620	4
FLAT COMPRESSIVE FORCE AT 23°C	ISO 604	MPa	-	-	450	300	5
FLAT COMPRESSIVE FORCE AT 200°C	ISO 604	MPa	-	-	300	-	5
TENSILE STRENGTH	ISO 527	MPa	-	-	-	375	3300
CUTTING VOLTAGE	IEC 60893	MPa	-	-	-	30	3300
<b>ELECTRICAL PROPERTIES AT 23°C</b>							
INSULATION RESISTANCE AFTER IMMERSION IN WATER	IEC 60167	Ω	1.00E+7	2.00E+6	-	1.00E+12	21
VOLTAGE FALL AT 90°C IN OIL	IEC 60243-1	kV	-	5	-	80	21
FLAT ELECTRIC FORCE	IEC 60243-1	kV/mm	-	0.5	23	20	> 10 <sup>14</sup>
RELATIVE PERMITTIVITY AT 1MHz	IEC 60250	-	-	-	-	4.9	> 10 <sup>14</sup>
DISSIPATION FACTOR AT 1MHz	IEC 60250	-	-	-	-	0.019	> 10 <sup>13</sup>
COMPARATIVE TRACKING INDEX (CTI)	IEC 60112	V	-	-	-	500	> 10 <sup>13</sup>
TRANSVERSE DIELECTRIC RIGIDITY AT OIL	IEC 60243-1	kV/mm	-	-	20	-	3.4

The properties of the products contained in these data sheets are based on the results of typical tests of the material, which is why there may be some variations. Poly Lanema, Lda. does not guarantee the use of the product or that the information provided in this document is complete, accurate or useful. The customer must test the product to determine its properties and suitability for the intended use. Poly Lanema, Lda. expressly disclaims any liability for any damage, loss, cost or expense to any person, directly or indirectly. The information contained in these data sheets does not represent express or implied warranties, or any implied warranty or fitness for a particular use or purpose. Poly Lanema, Lda. shall not be liable for incidents, such as punitive or consequential damages

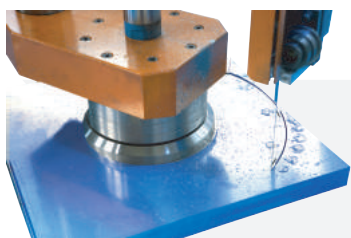

DIFFERENT TYPES OF HIGH PRECISION CUTTING **AT YOUR DISPOSAL!**





# WE CUT TO YOUR PROJECT MEASURE!

This catalogue and any data and specifications presented herein or on our website provide promotional and general information about the Engineering Plastics Products distributed by Polylanema, Lda. and serve as a guide. All data and descriptions related to the products are of a general nature, merely informative. All the data and specifications presented in this catalogue or on our site will not create or be implied to create any legal or contractual obligation. This catalogue and any data or specifications contained herein do not expressly or implicitly create any legal, contractual or warranty obligations whatsoever. No warranty of any kind, express or implied, is made relating to the information contained on these pages, including, but not limited to, all warranties provided by law, any implied warranty of merchantability, fitness for a particular purpose, and any warranty against hidden defects or retributory defects or vices. No information in this catalogue creates any express or implied warranty that the products described herein must conform to any description. Polylanema, Lda. assumes no liability for any products described herein to be suitable for any specific purpose for which a customer of Polylanema, Lda. can determine the purchase of such products, except and exclusive. Any illustration of the possible fields of application of the products should merely show the potential of these products, but any description does not constitute any kind of commitment or warranty. It remains the sole responsibility of the customer to test and evaluate the suitability and compatibility of the products for the intended applications, processes and uses and to choose the products that, according to its evaluation, meet the requirements applicable to the specific use of the final product. The customer assumes all responsibility for the application, processing or use of the above-mentioned information or product, or any consequence thereof, and must verify its quality and other properties. The products in this catalogue should not be used for applications involving medical devices that are intended to remain implanted in the human body continuously for longer than 24 hours [30 days] or are intended to remain in contact with internal human tissues or body fluids for more than 24 hours, or as critical components of medical devices that are essential for the continuation of human life. All the charts and tables presented in this catalogue are merely informative and their values are indicative only. This catalogue is the property of Lanema, and its total or partial copying/reproduction is forbidden without explicit consent.